

apex series



Apex adapts to the activities of individuals and groups, creating a workplace that compels achievement. Available in our 20 standard colors.

Features

Modern, contemporary style. Standard grommets, face lock and handles on all pedestals.

Handle

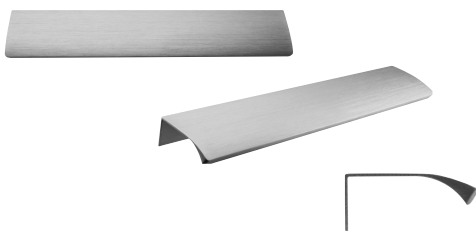

APH1
Smooth, curved edge handle in brushed aluminum
(Standard Apex handles)

Grommet

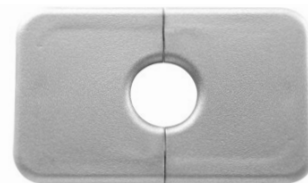

APRG1S
Standard Rectangular Grommet - Silver

apex series

15 DAYS and **20** DAYS Lead Time

Product Specifications

Colors

- 20 standard colors are available
- See color chart for upcharge information

Top / Worksurfaces

- 1" TFM (Thermally Fused Melamine) on industrial quality (45 lb.) particleboard
- 2 mm thermally-fused PVC edge banding
- Woodgrain direction on tops is horizontal

Chassis Construction

- TFM chassis fastened by screws, steel brackets, and/or concealed fasteners
- Adjustable leveling glides are provided on all units
- Apex Series shipped with temporary nail glides - remove at time of installation
- Chassis are all ¾" material including low credenza and free-standing storage tower

Drawer Interiors

- 9-ply Birch wood drawers

Drawer Suspension, Construction and Doors

- Drawers have full-extension, progressive-action slides with precision steel ball bearings
- APH1 handles standard
- Overlay drawer front and doors are standard on all separate storage units and separate file units
- All file and lateral drawers file legal size from side to side and letter front to back
- File drawer construction accommodates hanging files not stacked material on drawer bottom
- Hutch doors overlay

Cord Management

- A grommet is standard on all worksurfaces
- Optional wire management is available

Locks

- Locks standard on all support pedestals
- Silver, removable cores are standard for all locks
- Pedestal key numbers are randomly assigned to all locking pedestals
- Key alike may be specified at no charge
- Master keys and keyed-alike combinations are available

Disclaimer: Dimensions assigned in this price list are nominal. If exact measurements are required, the requirement must be specified in the order and specifically acknowledged by Maverick. Maverick reserves the right to change construction details and standards without notification, if necessary.

How to Order Apex Series

WORKSURFACE UNITS: TOPS, BASES, SUPPORTS

1. Product number: **AP WT 24 72 30R**
- ●
 ●
 ●
 ●
- Depth (Right)
 Width
 Depth
 Product Type: Worksurface (Wedge)
 Series Name: Apex

2. Specify worksurface and chassis finish
3. Specify drawer or door front finish (matching color edge band is standard). For two colors, add \$99 list
4. Specify data/power management. See page 210

WORKSURFACES (P. 187-192)

- Available in 20 colors
Specify **APWT 2 4 7 2 3 0 R**

PRIVACY SCREENS (P. 198-199)

- Frosted acrylic screens are mounted to worksurfaces.
Specify **APPSU 7 2**

LOW CREDENZA SUPPORT (P. 196)

- Attaches to worksurfaces to add support between low credenzas and tops.
Specify **APSLG 2 4**

LOW CREDENZAS (P. 201-202)

- Available in a myriad of configurations to meet several storage considerations
Specify **APSBL 2 0 7 2 R**



WORKSURFACE SUPPORTS (P.193-197)

- Worksurface support legs are ordered separately
- Required for supporting available Apex worksurfaces
Specify **APODL 3 0**



SILVER GROMMET (APRG1S)



HANDLE (APH1)

apex series

Power Management

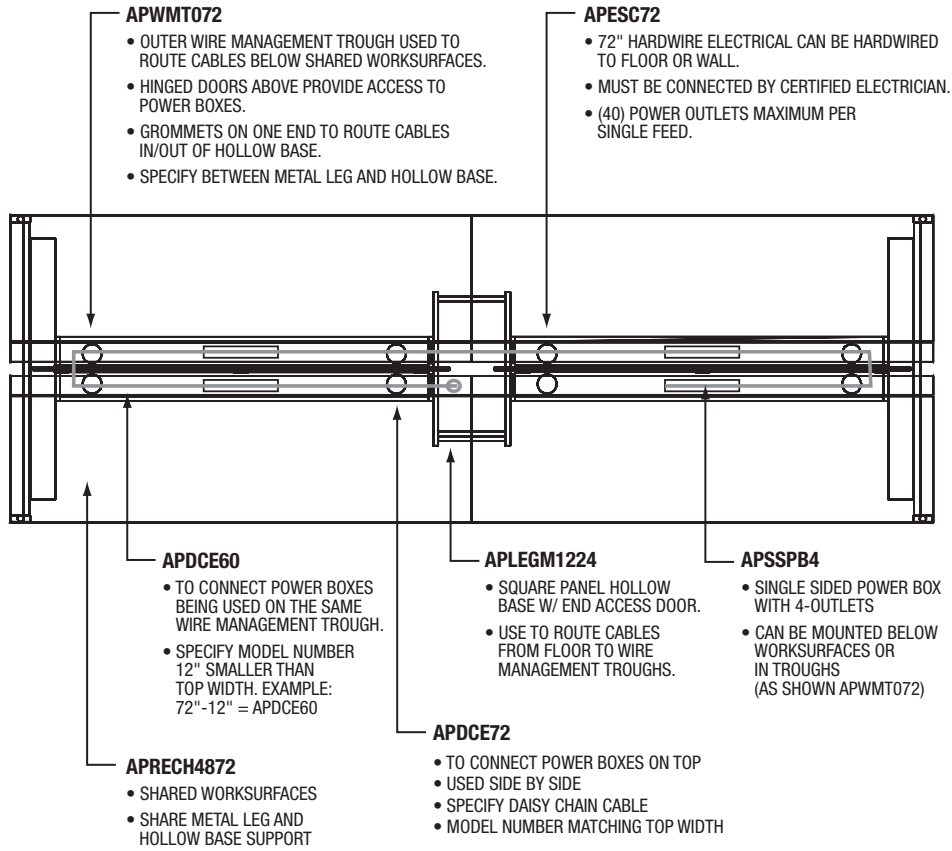

apex series

Statement of Line

WORKSURFACES

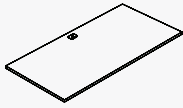

Rectangular
(APRT_____)

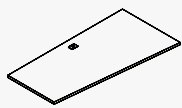

Wedge
(APWT_____)



Extended Compu-Corner
(APET_____)

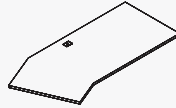

Compu-Corner Angled
(APAT_____)

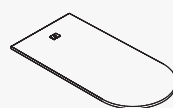

Bullet
(APBD_____)



Saddle Compu-Corner
(APST_____)

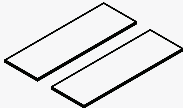

Rectangular Shared
(APRECH_____)



Corner
(APCCU_____)

WORKSURFACE SUPPORTS



External Stabilizer Bar
(APSB_)

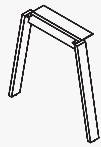

Apron Leg
(APOAL_)

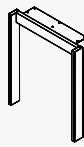

Double Post
(APODPL_)

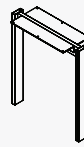

Shared Double Post Leg
(APDPM_)

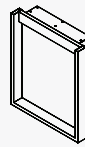

D-Leg
(APODL_)

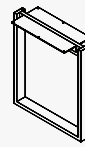

Shared D-Leg
(APMDL_)



28" Single Post
(APSPL28)

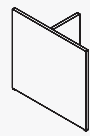

T-Leg
(APTLEG_)

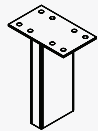

6" Single Post
(APSPL6)

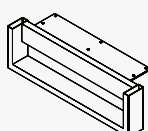

Short D-Leg
(APOSDL_)

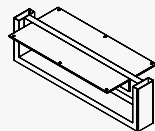

Short D-leg (Shared)
(APMSDL_)

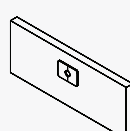

TFM Low Credenza
(APSLG_)

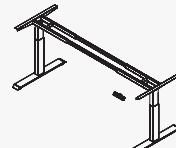

Adjustable Height Electrical Base
(MMLEGAHE_)

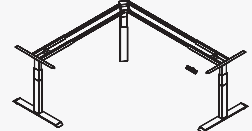

Adjustable Height Electrical Base
(MMLEGAHEL_)

SUPPORT PEDESTALS

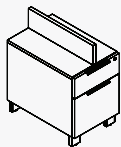

Box/File
(APPED A__BF)

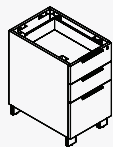

Box/Box/File
(APPED C__BBF)

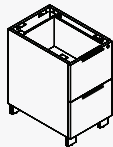

File/File
(APPED D__FF)

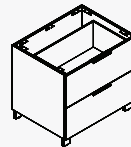

Lateral File
(APPED ___LF)

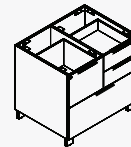

Personal Lateral File
(APPED ___PLF)

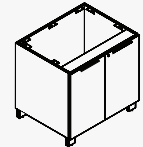

Hinged Door Cabinet
(APPED ___HDC)

LOW CREDENZAS

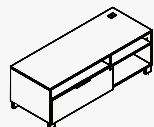

Single Lateral File
(APSL0_____)

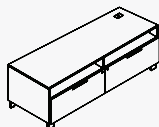

Double Lateral File
(APDOL_____)

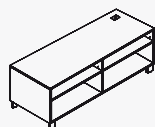

Open
(APDO_____)

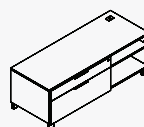

Single Box/Lateral
(APSBL_____)

apex series

Statement of Line

HUTCH AND WALL MOUNT CABINET

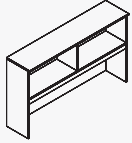

Open Hutch (No Doors)
(APH __ND)

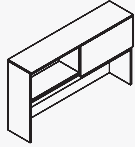

Hutch (One Sliding Door)
(APH __SD)

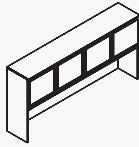

Hutch (Frosted Glass Doors)
(APH __WG)

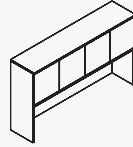

Hutch (Laminate Hinged Doors)
(APH __WD)

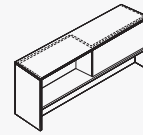

Hutch (Two-sided)
(APHSB __)

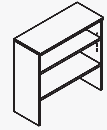

Bookcase Hutch
(APBCH)

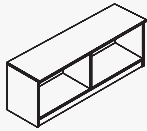

Wall Mount (Overhead)
No Doors
(APCFHO __)

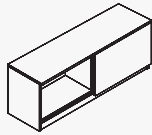

Wall Mount (Overhead)
One Sliding Door
(APCFHS __)

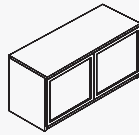

Wall Mount (Overhead)
Frosted Glass Doors
(APCFHG __)

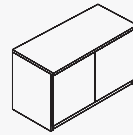

Wall Mount (Overhead)
Laminate Hinged Doors
(APCFHD __)

FREESTANDING STORAGE

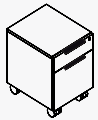

Pedestal
(APPED AX __BF)

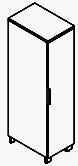

Single Cabinet
(APSTS __ __)

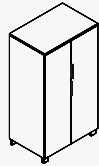

Double Cabinet
(APDST __ __)

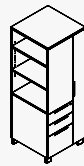

Personal Bookcase
(APPBDC __ __)



Single (Box/Box/File)
(APBCV __ __)

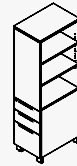

Personal Cabinet
(APBCPS __ __)

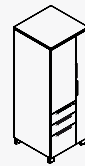

Personal Wardrobe
(APWCP __ __)

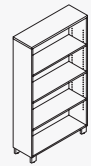

Bookcase
(APBC __)

PRIVACY SCREENS

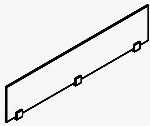

Top Frosted Acrylic
(APPSU __)

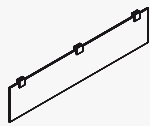

Frosted Acrylic Modesty
(APPSL __)

PRIVACY EXTENSIONS

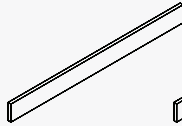

(TFM) Extension
(APPSUW __ __)

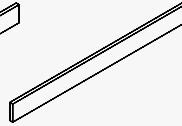

(HPL) Extension
(APPSUHP __ __)



Privacy Panel
(APPANEL __ __)

MODESTIES

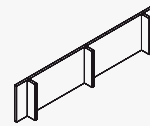

(TFM) Modesty
(APPSLW __)

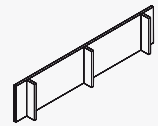

(HPL) Modesty
(APPSLHP __)

TACKBOARDS AND CUSHIONS

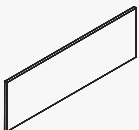

Tackboard
(APTKBD19 __)

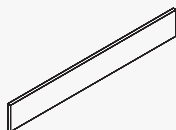

Tackboard (Lower)
(APTKBD08 __)

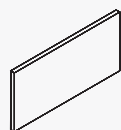

Tackboard (Upper)
(APTKBD15 __)

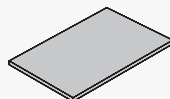

Cushion
(APCUH __ __)

BASES

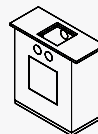

Square Panel (Hollow, Access)
(APASQWD __)

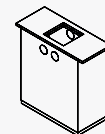

Square Panel (No Door)
(APASQND __)

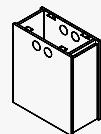

Square Panel (Hollow, End Access)
(APLEGM __)

apex series

Statement of Line

FREESTANDING TROUGHS

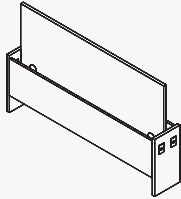

Trough with Center Panel

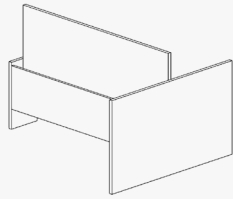

Trough with Center Panel & End Panel

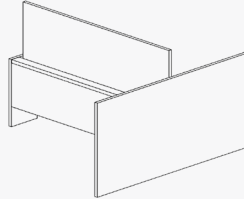

Trough with Doors, Center Panel & End Panel

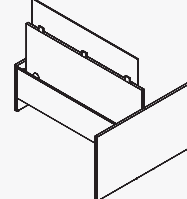

Trough with Center Panel, Privacy Screen & End Panel

CONFERENCE

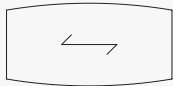

Boatshape
(APBS_...)

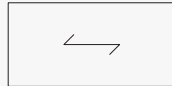

Rectangular
(APRE_...)

WIRE MANAGEMENT

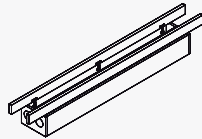

Middle Wire Management Trough
(APWMTM_...)

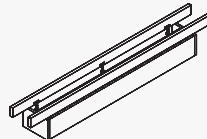

Outer Wire Management Trough
(APWMT0_...)

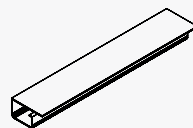

Plastic Wire Management Trough
(APPWM18)

DATA / POWER MANAGEMENT



Starter Cable
(APESC72)

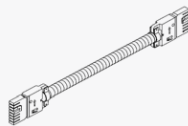

Daisy Chain Cable
(APDCE_...)



Power Box (4 Outlet)
(APSSPB4)



Power Box (8 Outlet)
(APSSPB8)

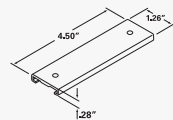

Vertibrate Wiring Module
(APVMT28)



Grommet
(APRPG1GW)

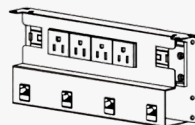

Power Module (4 Power, 4 RJ45)
(APSB4)

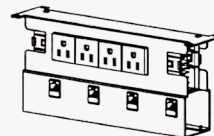

Power Module (8 Power, 4 RJ45)
(APSD8)



Tasklight
(APSKLTX24)

apex series

Configurations

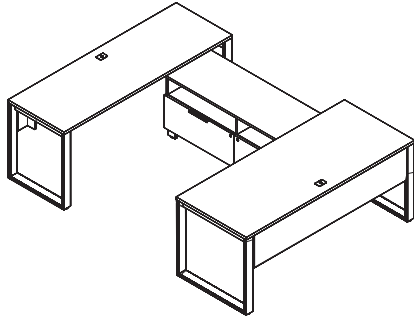

AP1L				
Qty	Model #	Description	List price	Extended Price
1	APRT3072	Rectangular Top Worksurface	\$394	\$394
1	APRT2472	Rectangular Top Worksurface (24"x72")	\$352	\$352
2	APODL30	D-Leg (30"Dx28"H)	\$420	\$840
2	APODL24	D-Leg (24"Dx28"H)	\$397	\$794
2	APSB72	External Stabilizer Bar (2"Dx1"Hx56"W)	\$85	\$170
2	APPSLHP72	HPL Modesty Panel (12"Hx65"W)	\$253	\$506
1	APODL2061L	Low Double Lateral File Credenza, Left (20"Hx61"Wx22"H)	\$1,930	\$1,930
Total			\$4,986	

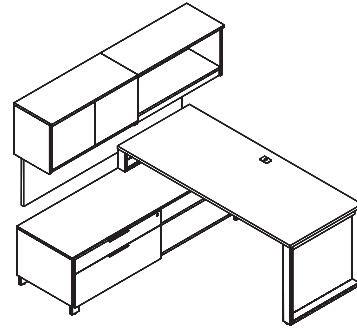

AP2L				
Qty	Model #	Description	List price	Extended Price
1	APRT3072	Rectangular Top Worksurface (30"x72")	\$394	\$394
1	APODL30	D-Leg (30"Dx28"H)	\$420	\$420
1	APOS30	Short D-leg (30"Dx6"H)	\$443	\$443
2	APSB72	External Stabilizer Bar (2"Dx1"Hx56"W)	\$85	\$170
1	APSB2472L	Low Single Box/Lateral Credenza, Left (24"Dx72"Wx22"H)	\$1,930	\$1,930
1	APCF0HD36	Wall Mounted Overhead Cabinet with Hinged Doors	\$812	\$812
1	APCF0H036	Wall Mounted Overhead Cabinet with no Doors	\$642	\$642
1	APTKBD1972	Tackboard (70"Wx19"H)	\$557	\$557
Total			\$5,368	

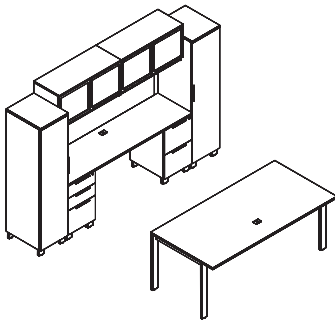

AP3				
Qty	Model #	Description	List price	Extended Price
1	APRT3672	Rectangular Top Worksurface (36"Dx72"W)	\$428	\$428
1	APRT2072	Rectangular Top Worksurface (20"Dx72"W)	\$337	\$337
2	APODPL30	Double Post Leg (30"Dx28"H)	\$420	\$840
2	APSB72	External Stabilizer (2"Dx1"Hx56"W)	\$85	\$170
1	APPED C20 BBF	Supporting Box/Box/File, No Top (20"Dx16"Wx28"H)	\$1,117	\$1,117
1	APPED D20 FF	Supporting File/File, No Top (20"Dx16"Wx28"H)	\$1,056	\$1,056
2	APCF0HG36	Wall Mounted Overhead Cabinet with Frosted Glass Doors (14 3/4"Dx36"Wx18 1/2"H)	\$977	\$1,954
1	APTKBD1972	Tackboard (70"Wx19"H)	\$557	\$557
1	APSTS2065L	Single Storage Cabinet, Left (20"Dx16"Wx65"H)	\$1,477	\$1,477
1	APSTS2065R	Single Storage Cabinet, Right (20"Dx16"Wx65"H)	\$1,477	\$1,477
Total			\$9,413	

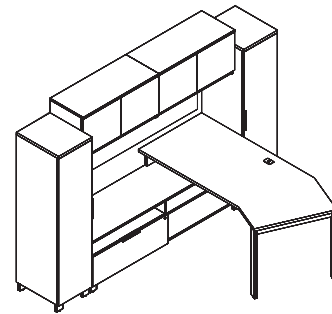

AP4L				
Qty	Model #	Description	List price	Extended Price
1	APAT3072R	Angle Compu-Corner Worksurface (30"Dx72"W)	\$538	\$538
1	APODPL30	Double Post Leg (30"Dx28"H)	\$420	\$420
1	APSELEG30	Low Credenza TFM Support (16"Dx6"H)	\$90	\$90
2	APSB72	External Stabilizer Bar (2"Dx1"Hx56"W)	\$85	\$170
1	APSL02072L	Low Single Lateral Credenza, Left (20"Dx72"Wx22"H)	\$1,817	\$1,817
2	APCF0HD36	Wall Mounted Overhead Cabinet with Hinged Doors	\$812	\$1,624
1	APTKBD1972	Tackboard (70"Wx19"H)	\$557	\$557
1	APSTS2065L	Single Storage Cabinet, Left (20"Dx16"Wx65"H)	\$1,477	\$1,477
1	APSTS2065R	Single Storage Cabinet, Right (20"Dx16"Wx65"H)	\$1,477	\$1,477
Total			\$8,170	

apex series

Configurations

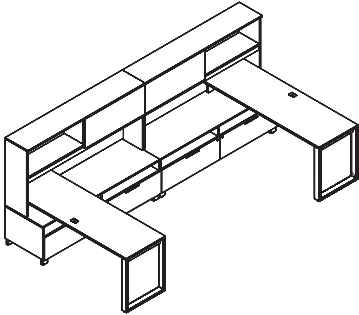

AP5				
Qty	Model #	Description	List price	Extended Price
2	APRT2472	Rectangular Top Worksurface (24"x72")	\$352	\$704
2	APODL24	D-Leg (16"Dx28"H)	\$397	\$794
2	APSLLEG24	Low Credenza TFM Support (18"Dx6"H)	\$85	\$170
4	APSB72	External Stabilizer Bar (2"Dx1"Hx56"W)	\$85	\$340
1	APODL2472L	Double Lateral File w/Open Shelf Credenza, Left (24"Dx72"Wx22"H)	\$2,078	\$2,078
1	APODL2472R	Double Lateral File w/Open Shelf Credenza, Right (24"Dx72"Wx22"H)	\$2,078	\$2,078
2	APH72 SD	Hutch w/One Sliding Door (14"Dx72"Wx36"H)	\$1,170	\$2,340
2	APTkbd1972	Hutch Tackboard (1"Dx70"Wx19"H)	\$557	\$1,114
			Total	\$9,618

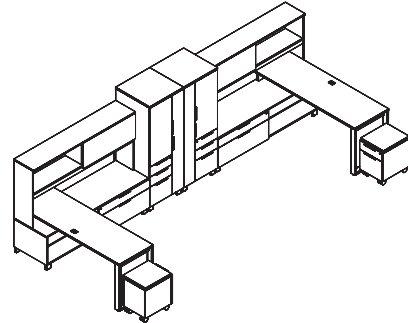

AP6				
Qty	Model #	Description	List price	Extended Price
2	APRT2472	Rectangular Top Worksurface (24"x72")	\$352	\$704
2	APODL24	D-Leg (16"Dx28"H)	\$397	\$794
2	APSLLEG24	Low Credenza TFM Support (18"Dx6"H)	\$85	\$170
4	APSB72	External Stabilizer Bar (2"Dx1"Hx56"W)	\$85	\$340
1	APSBL2472L	Single Box/Lateral Credenza, Left (24"Dx72"Wx22"H)	\$1,930	\$1,930
1	APSBL2472R	Single Box/Lateral Credenza, Right (24"Dx72"Wx22"H)	\$1,930	\$1,930
2	APH72 SD	Hutch w/One Sliding Door (14"Dx72"Wx36"H)	\$1,170	\$2,340
2	APTkbd1972	Hutch Tackboard (1"Dx70"Wx19"H)	\$557	\$1,114
2	APPED AX20 BF	Mobile Box/File Pedestal (19"Dx16"Wx22"H)	\$891	\$1,782
2	APCUH2016	Pedestal Cushion (19"Dx16"W)	\$235	\$470
1	APWCP2465R	Personal Wardrobe w/Storage Cabinet, Right (24"Dx24"Wx65"H)	\$1,766	\$1,766
1	APWCP2465L	Personal Wardrobe w/Storage Cabinet, Left (24"Dx24"Wx65"H)	\$1,766	\$1,766
			Total	\$15,106

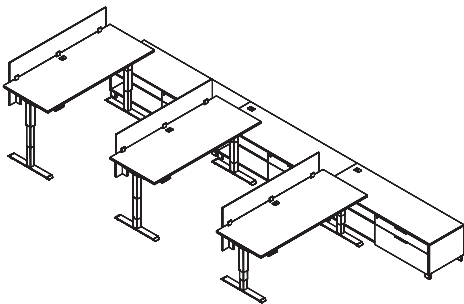

AP7R				
Qty	Model #	Description	List price	Extended Price
3	APRT3072	Rectangular Top Worksurface (30"Dx72"W)	\$394	\$1,182
3	MMLEGAHE30S	Adjustable Height Electrical Legs (24/30"Dx72"Wx23-48"H) Silver	\$1,366	\$4,098
3	APPSU72	Top Frosted Acrylic Privacy Screen (65"Wx12"Hx1"D)	\$602	\$1,806
3	APPSLHP72	HPL Modesty Panel (65"Wx12"H)	\$253	\$759
3	APSBL2472R	Single Box/Lateral Credenza, Right (24"Dx72"Wx22"H)	\$1,930	\$5,790
			Total	\$13,635

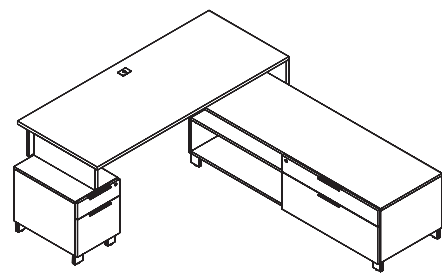

AP8R				
Qty	Model #	Description	List price	Extended Price
1	APRT3072	Rectangular Top Worksurface (30"Dx72"W)	\$394	\$394
1	APPED A24 BF	Supporting Box/File Pedestal (24"Dx16"Wx28"H)	\$1,068	\$1,068
1	APTLEG30	T-Leg (30"Dx12"Wx28"H)	\$153	\$153
1	APSB72	External Stabilizer Bar (2"Dx65"Wx1"H)	\$85	\$85
1	APPSLHP72	HPL Modesty Panel (65"Wx12"H)	\$253	\$253
1	APSBL2472R	Single Box/Lateral Credenza, Right (24"Dx72"Wx22"H)	\$1,930	\$1,930
			Total	\$3,883

apex series

Configurations

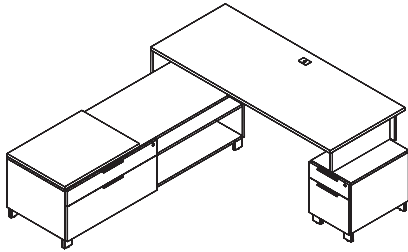

AP9L				
Qty	Model #	Description	List price	Extended Price
1	APRT3072	Rectangular Top Worksurface (30"Dx72"W)	\$394	\$394
1	APPED A24 BF	Supporting Box/File Pedestal (24"Dx16"Wx28"H)	\$1,068	\$1,068
1	APTLEG30	T-Leg (30"Dx12"Wx28"H)	\$153	\$153
1	APSB72	External Stabilizer Bar (2"Dx65"Wx1"H)	\$85	\$85
1	APPSLHP72	HPL Modesty Panel (65"Wx12"H)	\$253	\$253
1	APSBL2472L	Single Box/Lateral Credenza, Left (24"Dx72"Wx22"H)	\$1,930	\$1,930
1	APCUH2430	Credenza Cushion (23"Dx30"W)	\$284	\$284
Total			\$4,167	

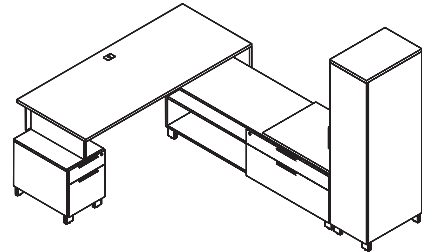

AP10R				
Qty	Model #	Description	List price	Extended Price
1	APRT3072	Rectangular Top Worksurface (30"Dx72"W)	\$394	\$394
1	APPED A24 BF	Supporting Box/File Pedestal (24"Dx16"Wx28"H)	\$1,068	\$1,068
1	APTLEG30	T-Leg (30"Dx12"Wx28"H)	\$153	\$153
2	APSB72	External Stabilizer Bar (2"Dx65"Wx1"H)	\$85	\$170
1	APPSL72	Frosted Acrylic Modesty (65"Wx12"H)	\$602	\$602
1	APSBL2472R	Single Box/Lateral Credenza, Right (24"Dx72"Wx22"H)	\$1,930	\$1,930
1	APCUH2430	Credenza Cushion (23"Dx30"W)	\$284	\$284
1	APSTS2465R	Single Storage Cabinet, Right (24"Dx16"Wx65"H)	\$1,562	\$1,562
Total			\$6,163	

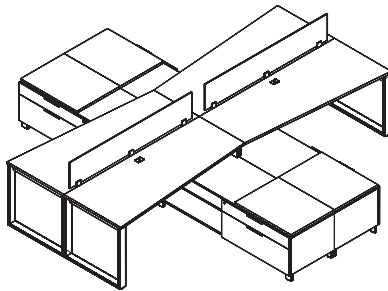

AP11				
Qty	Model #	Description	List price	Extended Price
2	APWT2472 30L	Wedge Top Worksurface (30/24"Dx72"W)	\$411	\$822
2	APWT2472 30R	Wedge Top Worksurface (24/30"Dx72"W)	\$411	\$822
4	APODL30	D-Leg (30"Dx28"H)	\$420	\$1,680
4	APSLG30	Low Credenza TFM Support (22"Dx6"H)	\$90	\$360
8	APSB72	External Stabilizer Bar (2"Dx65"Wx1"H)	\$85	\$680
2	APPSU72	Top Frosted Acrylic Privacy Screen (65"Wx12"H)	\$602	\$1,204
2	APSBL2472R	Single Box/Lateral Credenza, Right (24"Dxx72"Wx22"H)	\$1,930	\$3,860
2	APSBL2472L	Single Box/Lateral Credenza, Left (24"Dx72"Wx22"H)	\$1,930	\$3,860
4	APCUH2430	Credenza Cushion (23"Dx30"W)	\$284	\$1,136
Total			\$14,424	

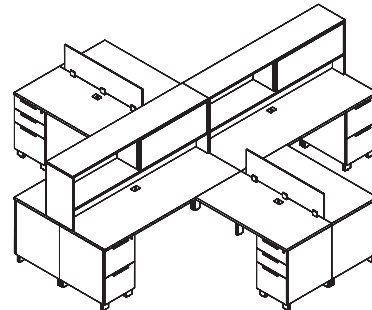

AP12				
Qty	Model #	Description	List price	Extended Price
4	APRT2472	Rectangular Top Worksurface (24"Dx72"W)	\$352	\$1,408
2	APHSB72	Two-sided Hutch, Shared Bins (14"Dx36"Hx72"W)	\$937	\$1,874
4	APRT2448	Rectangular Top Worksurface (24"Dx48"W)	\$238	\$952
2	APDPML24	Shared Double Post Leg (24"Dx28"H)	\$402	\$804
4	APPED C24 BBF	Supporting Box/Box/File Pedestal (24"Dx16"Wx28"H)	\$1,125	\$4,500
4	APPED D24 FF	Supporting File/File Pedestal (24"Dx16"Wx28"H)	\$1,078	\$4,312
4	APSB60	External Stabilizer Bar (44"W)	\$74	\$296
2	APPSU48	Top Frosted Acrylic Privacy Screen (41"Wx12"H)	\$409	\$818
4	APTKBD0872	Lower Tackboard (70"Wx8"H)	\$374	\$1,496
4	APTKBD1536	Upper Tackboard (35"Wx15"H)	\$341	\$1,364
4	APGANG1	Ganging Hardware (4"Dx6"Wx25"H)	\$37	\$148
Total			\$17,972	

apex series

Configurations

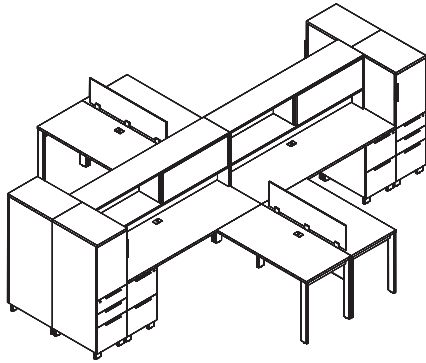

AP13				
Qty	Model #	Description	List price	Extended Price
4	APRT2472	Rectangular Top Worksurface (24"Dx72"W)	\$352	\$1,408
4	APRT2448	Rectangular Top Worksurface (24"Dx48"W)	\$238	\$952
4	APODPL24	Double Post Leg (24"Dx28"H)	\$323	\$1,292
2	APDPML24	Shared Double Post Leg (24"Dx28"H)	\$402	\$804
4	APPED D24 FF	Supporting File/File Pedestal (24"Dx16"Wx28"H)	\$1,078	\$4,312
4	APSB60	External Stabilizer Bar (44"W)	\$74	\$296
2	APPSU48	Top Frosted Acrylic Privacy Screen (41"Wx12"H)	\$409	\$818
2	APBCV2454L	Single Storage Box/Box/File Upper Door, Left (24"Dx16"Wx54"H)	\$1,766	\$3,532
2	APBCV2454R	Single Storage Box/Box/File Upper Door, Right (24"Dx16"Wx54"H)	\$1,766	\$3,532
2	APHSB72	Two-sided Hutch w/ Shared Bins (14"Dx72"Wx25"H)	\$937	\$1,874
4	APTKBD0872	Lower Tackboard (70"Wx8"H)	\$374	\$1,496
4	APTKBD1536	Upper Tackboard (35"Wx15"H)	\$341	\$1,364
4	APGANG1	Ganging Hardware (4"Dx6"Wx25"H)	\$37	\$148
Total			\$21,828	

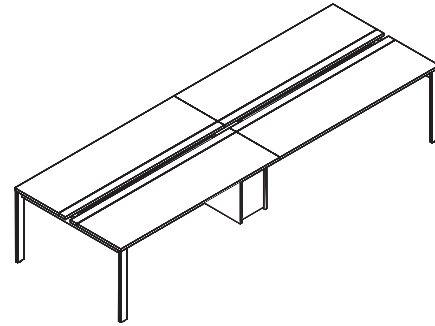

AP14				
Qty	Model #	Description	List price	Extended Price
2	APRECH4872	Shared Rectangular Top Worksurface (48"Dx72"W)	\$704	\$1,408
2	APODPL48	Double Post Leg (48"Dx28"H)	\$426	\$852
2	APWMT072	Outer Wire Management Trough (59"Wx8"Hx10"D)	\$829	\$1,658
4	APSB72	External Stabilizer Bar (56"W)	\$85	\$340
1	APLEGM1224	Square Panel Base Hollow, w/End Access Door (12"Dx24"W)	\$432	\$432
1	APESC72	Electrical Starter Cable (72")	\$196	\$196
4	APSSPB4	Single Sided Power Box w/4-Power Outlets	\$153	\$612
2	APDCE60	52" Daisy Chain Electrical Cable	\$196	\$392
1	APDCE72	64" Daisy Chain Electrical Cable	\$216	\$216
2	APGANG1	Ganging Hardware (4"Dx6"Wx25"H)	\$37	\$74
Total			\$6,180	

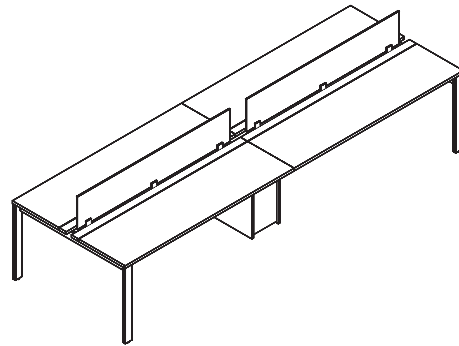

AP15				
Qty	Model #	Description	List price	Extended Price
2	APRECH4872	Rectangular (Shared) Worksurface (48"Dx72"W)	\$704	\$1,408
2	APODPL48	Double Post Leg (48"Dx28"H)	\$426	\$852
2	APWMT072	Outer Wire Management Trough (59"Wx8"Hx10"D)	\$829	\$1,658
4	APSB72	External Stabilizer Bar (56"W)	\$85	\$340
1	APLEGM1224	Square Panel Base Hollow, w/End Access Door (12"Dx24"W)	\$432	\$432
2	APPSU72	Top Frosted Acrylic Privacy Screen (65"Wx12"H)	\$602	\$1,204
1	APESC72	Electrical Starter Cable (72")	\$196	\$196
4	APSSPB4	Single Sided Power Box w/4-Power Outlets	\$153	\$612
2	APDCE60	52" Daisy Chain Electrical Cable	\$196	\$392
1	APDCE72	64" Daisy Chain Electrical Cable	\$216	\$216
2	APGANG1	Ganging Hardware (4"Dx6"Wx25"H)	\$37	\$74
Total			\$7,384	

apex series

Configurations

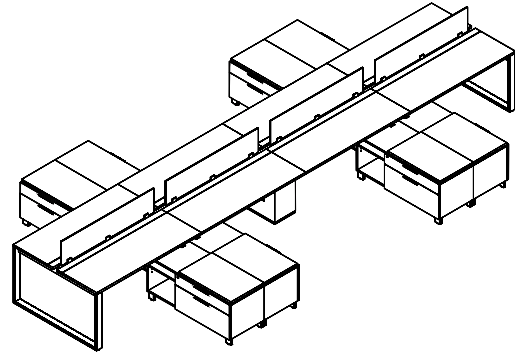
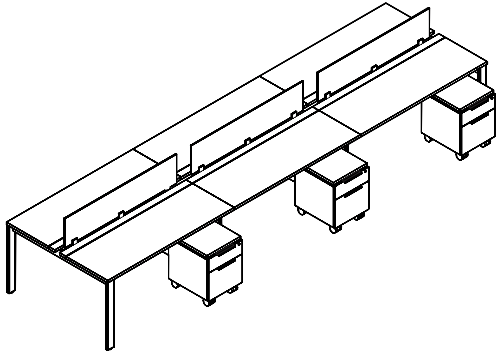

AP16

Qty	Model #	Description	List price	Extended Price
3	APRECH4860	Rectangular (Shared) Worksurface (48"Dx60"W)	\$632	\$1,896
2	APODPL48	Double Post Leg (48"Dx28"H)	\$426	\$852
1	APWMTM60	Middle Wire Management Trough (48"Wx8"Hx10"D)	\$671	\$671
2	APWMT060	Outer Wire Management Trough (47"Wx8"Hx10"D)	\$658	\$1,316
6	APSB60	External Stabilizer Bar (44"W)	\$74	\$444
2	APLEGM1224	Square Panel Base Hollow, w/End Access Door (12"Dx24"W)	\$432	\$864
3	APPSU60	Top Frosted Acrylic Privacy Screen (53"Wx12"H)	\$591	\$1,773
6	APPED AX20 BF	Mobile Box/File Pedestal (19"Dx16"Wx22"H)	\$891	\$5,346
1	APESC72	Electrical Starter Cable (72")	\$196	\$196
6	APSSPB4	Single Sided Power Box w/4-Power Outlets	\$153	\$918
2	APDCE48	40" Daisy Chain Electrical Cable	\$176	\$352
3	APDCE60	52" Daisy Chain Electrical Cable	\$196	\$588
4	APGANG1	Ganging Hardware (4"Dx6"Wx25"H)	\$37	\$148
Total			\$15,364	

AP17

Qty	Model #	Description	List price	Extended Price
4	APRECH4860	Rectangular (Shared) Worksurface (48"Dx60"W)	\$632	\$2,528
2	APODL48	D-Leg (48"Dx28"H)	\$494	\$988
2	APWMT060	Outer Wire Management Trough (47"Wx8"Hx10"D)	\$658	\$1,316
2	APWMTM60	Middle Wire Management Trough (48"Wx8"Hx10"D)	\$671	\$1,342
8	APSB60	External Stabilizer Bar (44"W)	\$74	\$592
2	APASQND1224	Square Panel Base Hollow, No Door (12"Dx24"W)	\$579	\$1,158
1	APASQWD1224	Square Panel Base Hollow, w/Access Door (12"Dx24"W)	\$955	\$955
4	APPSU60	Top Frosted Acrylic Privacy Screen (53"Wx12"H)	\$591	\$2,364
4	APSBLL2048R	Single Box/Lateral Credenza, Right (20"Dx48"Wx22"H)	\$1,653	\$6,612
4	APSBLL2048L	Single Box/Lateral Credenza, Left (20"Dx48"Wx22"H)	\$1,653	\$6,612
8	APCUH2030	Low Credenza Cushion (19"Dx30"Wx1"H)	\$267	\$2,136
1	APESC72	Electrical Starter Cable (72")	\$196	\$196
8	APSSPB4	Single Sided Power Box w/4-Power Outlets	\$153	\$1,224
2	APDCE48	40" Daisy Chain Electrical Cable	\$176	\$352
5	APDCE60	52" Daisy Chain Electrical Cable	\$196	\$980
6	APGANG1	Ganging Hardware (4"Dx6"Wx25"H)	\$37	\$222
Total			\$29,577	

apex series

Configurations

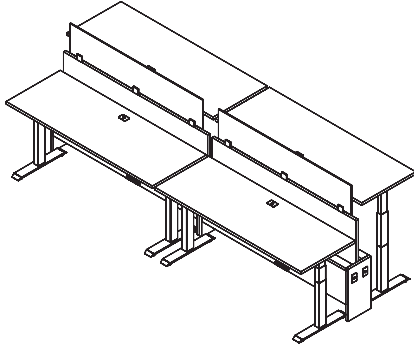

AP18

Qty	Part Number	Part Description	List Price	Extended
4	APRT 2465	Rectangular Top Worksurface, Silver Sq Grom Ctr (24"D x 65"W x 1")	\$321	\$1,284
4	MMLEGAHE24S	Silver Electrical Height Adjustable Base (For 24"D Top)	\$1,366	\$5,464
2	APWMT6636WDPS	Trough with Hinged Doors, Ctr Panel 36"H, Privacy Screen - APPSU66 (10"D x 66"W x 36"H)	\$1,555	\$3,110
1	APESC 72	Electrical Starter Cable 72"W (8-Wire, 4-Circuit)	\$196	\$196
4	APSSPB 4	Single Sided Power Box with 4 Power Outlets	\$153	\$612
2	APDCE 66	58"W Daisy Chain Electrical Cable (For 66"W Trough)	\$210	\$420
1	APDCE 60	46"W Daisy Chain Electrical Cable (For 54"W Trough)	\$196	\$196
Total List:			\$11,282	

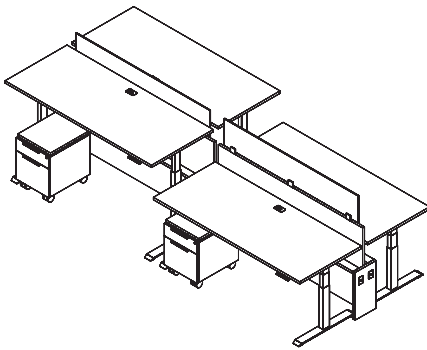

AP19

Qty	Part Number	Part Description	List Price	Extended
4	APRT 3071	Rectangular Top Worksurface (30"D x 71"W x 1")	\$375	\$1,500
4	MMLEGAHE30S	Silver Electrical Height Adjustable Base (For 30"D Top)	\$1,366	\$5,464
2	APWMT7236WDPS	Trough with Hinged Doors, Ctr Panel 36"H, Privacy Screen - APPSU72 (10"D x 72"W x 36"H)	\$1,592	\$3,184
4	APPED AX20 BF	Mobile Box/ File Pedestal Face Lock, APH1 (20"D x 16"W x 22"H)	\$891	\$3,564
4	APCUH 2016	Mobile Pedestal Cushion (19"D x 16"W x 1"H)	\$235	\$940
1	APESC 72	Electrical Starter Cable 72"W (8-Wire, 4-Circuit)	\$196	\$196
1	APSSPB 4	Single Sided Power Box with 4 Power Outlets	\$153	\$153
4	APDCE 72	64"W Daisy Chain Electrical Cable (For 72"W Trough)	\$216	\$864
1	APDCE 60	52"W Daisy Chain Electrical Cable (For 60"W Trough)	\$196	\$196
4	APRPG1S	Silver Rectangular Power Grommet (1 PWR, 2 USB) Ctr Top APRT3071	\$388	\$1,552
Total List:			\$17,613	

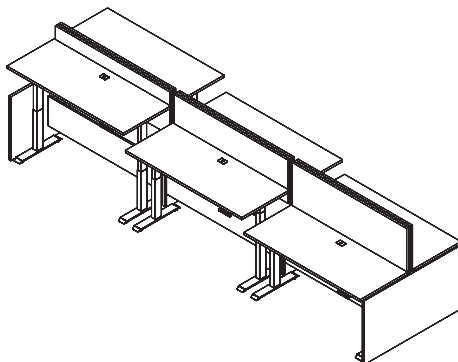

AP20

Qty	Part Number	Part Description	List Price	Extended
6	APRT 2459	Rectangular Top Worksurface, Silver Sq Grom Ctr (24"D x 59"W x 1")	\$301	\$1,806
6	MMLEGAHE24S	Silver Electrical Height Adjustable Base (For 24"D Top)	\$1,366	\$8,196
1	APWMT6048ND	Trough No Doors, Center End Panel 48"H (10"D x 66"W x 48"H)	\$759	\$759
2	APWMT6048ND48	Trough No Doors, Center End Panel 48"W and End Panel (10"D x 66"W x 48"H)	\$939	\$1,878
6	APTKBD 1960	Tackboard (58"W x 19"H) For 60"W Trough	\$465	\$2,790
1	APESC 72	Electrical Starter Cable 72"W (8-Wire, 4-Circuit)	\$196	\$196
6	APSSPB 4	Single Sided Power Box with 4 Power Outlets	\$153	\$918
4	APDCE 60	52"W Daisy Chain Electrical Cable (For 60"W Trough)	\$196	\$784
1	APDCE 48	40"W Daisy Chain Electrical Cable (For 48"W Trough)	\$176	\$176
Total List:			\$17,503	

apex series

Configurations

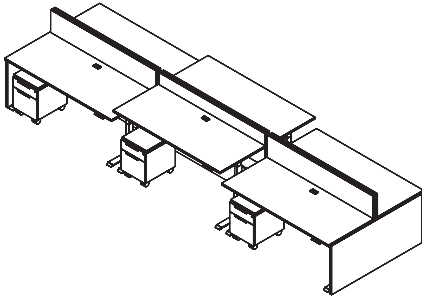

AP21

Qty	Part Number	Part Description	List Price	Extended
6	APRT 3071	Rectangular Top Worksurface, Silver Sq Grom Ctr (30"D x 71"W x 1")	\$375	\$2,250
6	MMLEGAHE30S	Silver Electrical Height Adjustable Base (For 30"D Top)	\$1,366	\$8,196
1	APWMT7242ND	Trough No Doors with Center Panel 48"H (10"D x 72"W x 42"H)	\$799	\$799
2	APWMT7242ND60	Trough No Doors with Center Panel 42"H & 60"W End Panel (10"D x 72"W x 42"H)	\$1,014	\$2,028
6	APTKBD 1972	Tackboard (70"W x 19"H) For 72"W Trough	\$530	\$3,180
6	APPED AX20 BF	Mobile Box/File Pedestal Face Lock, APH1 Handles (20"D x 16"W x 22"H)	\$891	\$5,346
6	APCUH 2016	Mobile Pedestal Cushion (19"D x 16"W x 1"H)	\$235	\$1,410
1	APESC 72	Electrical Starter Cable 72"W (8-Wire, 4-Circuit)	\$196	\$196
6	APSSPB 4	Single Sided Power Box with 4 Power Outlets	\$153	\$918
4	APDCE 72	64"W Daisy Chain Electrical Cable	\$216	\$864
1	APDCE 60	52"W Daisy Chain Electrical Cable	\$196	\$196
6	APRPG1S	Silver Rectangular Power Grommet (1 PWR, 2 USB) Ctr Top APRT 3071	\$388	\$2,328

Total List: \$27,711

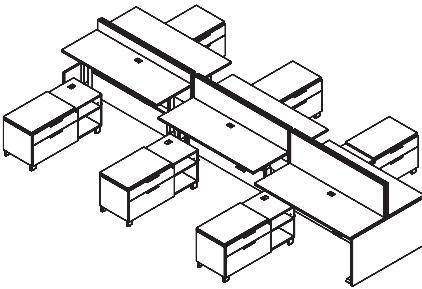

AP22

Qty	Part Number	Part Description	List Price	Extended
6	APRT 2465	Rectangular Top Worksurface, Silver Sq Grom Ctr (24"D x 65"W x 1")	\$321	\$1,926
6	MMLEGAHE24S	Silver Electrical Height Adjustable Base (For 24"D Top)	\$1,366	\$8,196
1	APWMT6648WD	Trough with Hinged Doors, Ctr Panel 48"H (10"D x 66"W x 48"H)	\$1,049	\$1,049
2	APWMT6648WD48	Trough with Hinged Doors, Ctr Panel 48"H & 48"W End Panel (10"D x 66"W x 48"H)	\$1,229	\$2,458
6	APTKBD 1966	Tackboard (64"W x 19"H) for 66"W Trough	\$497	\$2,982
3	APSBL 2048L	Single Box/ Lateral Credenza, Left (20"D x 48"W x 22"H)	\$1,653	\$4,959
3	APSBL 2048R	Single Box/ Lateral Credenza, Right (20"D x 48"W x 22"H)	\$1,653	\$4,959
6	APCUH 2030	Credenza Cushion (19"D x 30"W x 1 "H)	\$267	\$1,602
1	APESC 72	Electrical Starter Cable 72"W (8-Wire, 4-Circuit)	\$196	\$196
6	APSSPB 4	Single Sided Power Box with 4 Power Outlets	\$153	\$918
4	APDCE 66	58"W Daisy Chain Electrical Cable (For 66"W Trough)	\$210	\$840
1	APDCE 54	46"W Daisy Chain Electrical Cable (For 54"W Trough)	\$196	\$196

Total List: \$30,281

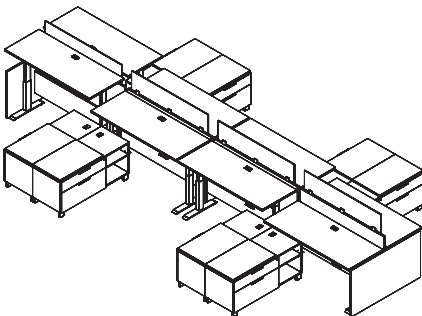

AP23

Qty	Part Number	Part Description	List Price	Extended
8	APRT 2459	Rectangular Top Worksurface, Silver Sq Grom Ctr (24"D x 59"W x 1")	\$301	\$2,408
8	MMLEGAHE24S	Silver Electrical Height Adjustable Base (For 24"D Top)	\$1,366	\$10,928
2	APWMT6036NDPS	Trough No Doors with Ctr Panel 36"H, Privacy Screen APPSU60 (10"D x 60"W x 36"H)	\$1,266	\$2,532
2	APWMT6036WD48PS	Trough No Doors with Ctr Panel 36"H & 48"W End Panel, Privacy Screen - APPSU60 (10"D x 60"W x 36"H)	\$1,696	\$3,392
4	APSBL 2048L	Single Box/ Lateral Credenza, Left (20"D x 48"W x 22"H)	\$1,653	\$6,612
4	APSBL 2048R	Single Box/ Lateral Credenza, Right (20"D x 48"W x 22"H)	\$1,653	\$6,612
8	APCUH 2030	Credenza Cushion (19"D x 30"W x 1 "H)	\$267	\$2,136
1	APESC 72	Cable 72"W (8-Wire, 4-Circuit)	\$196	\$196
8	APSSPB 4	Single Sided Power Box with 4 Power Outlets	\$153	\$1,224
6	APDCE 66	52"W Daisy Chain Electrical Cable (For 60"W Trough)	\$210	\$1,260
1	APDCE 48	40"W Daisy Chain Electrical Cable (For 48"W Trough)	\$176	\$176
8	APRPG1S	Silver Rectangular Power Grommet (1 PWR, 2 USB) Ctr top APRT 2459	\$388	\$3,104

Total List: \$40,580

apex series

Worksurfaces

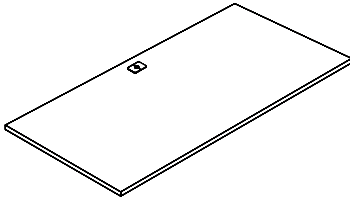

Rectangular Worksurface

Model#	Depth	Width	Height	Weight	Cube	Price
APRT2030	20"	30"	1"	16	1	\$193
APRT2031	20"	31"	1"	17	1	\$193
APRT2036	20"	36"	1"	19	1	\$200
APRT2042	20"	42"	1"	22	1	\$209
APRT2048	20"	48"	1"	25	1	\$224
APRT2054	20"	54"	1"	29	1	\$264
* APRT2060	20"	60"	1"	32	1	\$295
APRT2062	20"	62"	1"	33	1	\$301
* APRT2066	20"	66"	1"	35	1	\$328
* APRT2072	20"	72"	1"	38	1	\$337
APRT2430	24"	30"	1"	19	1	\$205
APRT2431	24"	31"	1"	20	1	\$205
15 APRT2436	24"	36"	1"	23	1	\$212
15 APRT2442	24"	42"	1"	27	1	\$228
15 APRT2448	24"	48"	1"	30	1	\$238
15 APRT2454	24"	54"	1"	34	1	\$301
15 * APRT2460	24"	60"	1"	38	1	\$315
APRT2462	24"	62"	1"	39	1	\$318
15 * APRT2466	24"	66"	1"	42	1	\$337
15 * APRT2472	24"	72"	1"	45	1	\$352
APRT3048	30"	48"	1"	38	1	\$261
APRT3054	30"	54"	1"	43	1	\$337
15 * APRT3060	30"	60"	1"	47	2	\$346
* APRT3066	30"	66"	1"	52	2	\$375
15 * APRT3072	30"	72"	1"	57	2	\$394
* APRT3660	36"	60"	1"	57	2	\$379
* APRT3666	36"	66"	1"	62	2	\$409
* APRT3672	36"	72"	1"	68	2	\$428

1 silver square grommet (top center) standard.
 Grommet on 20", 24" & 30"D is 3" clear from approach. On 36"D is 9" clear from approach.
 Depending on support configuration, external stabilizer may be required on tops of 54" or greater.
 See external stabilizer bar selection guide on P. 194.

* 2 stabilizer bars are required on 60", 66" & 72" wide worksurfaces when supporting with left & right Double post leg, D-legs or T-legs

Connecting Hardware (Brackets & Screws)

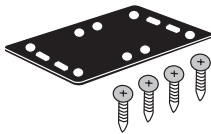

Model#	Depth	Width	Height	Weight	Cube	Price
15 AP GANG1	4"	6"	.25"	2	1	\$37
15 AP GANG2	4"	6"	.25"	3	1	\$74

NOTE: Must be field installed

* If using as a return top, specify APGANG1 (2 brackets w/#8x1" wood screws supplied)

* If using as a Bridge Top, specify APGANG2 (4 brackets w/#8x1" wood screws supplied)

apex series

Worksurfaces

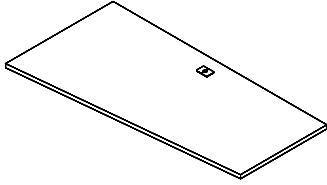

Wedge Worksurface, Left

Model#	(L)	(B)	(E)	(W)	Weight	Cube	Price
* APWT206024L	60"	24"	20"	60"	38	1	\$334
* APWT206624L	66"	24"	20"	66"	42	1	\$358
* APWT207224L	72"	24"	20"	72"	45	1	\$375
15 * APWT246030L	60"	30"	24"	60"	47	2	\$364
* APWT246630L	66"	30"	24"	66"	52	2	\$388
15 * APWT247230L	72"	30"	24"	72"	57	2	\$411

1 silver square grommet (top center) standard. 3" clear from approach.
 See external stabilizer bar selection guide on P. 194.
 * 2 stabilizer bars are required on 60", 66" & 72" wide worksurfaces when supporting with left & right Double post leg, D-legs or T-legs

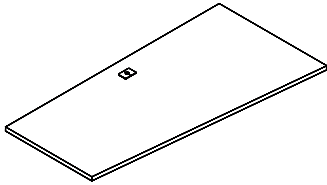

Wedge Worksurface, Right

Model#	(L)	(B)	(E)	(W)	Weight	Cube	Price
* APWT206024R	60"	24"	20"	60"	38	1	\$334
* APWT206624R	66"	24"	20"	66"	42	1	\$358
* APWT207224R	72"	24"	20"	72"	45	1	\$375
15 * APWT246030R	60"	30"	24"	60"	47	2	\$364
* APWT246630R	66"	30"	24"	66"	52	2	\$388
15 * APWT247230R	72"	30"	24"	72"	57	2	\$411

1 silver square grommet (top center) standard. 3" clear from approach.
 See external stabilizer bar selection guide on P. 194.
 * 2 stabilizer bars are required on 60", 66" & 72" wide worksurfaces when supporting with left & right Double post leg, D-legs or T-legs

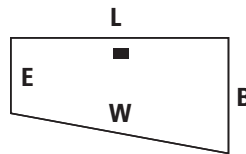

apex series

Worksurfaces

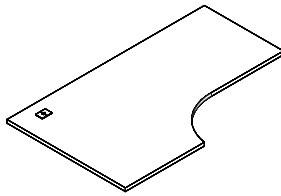

Extended Compu-Corner Worksurface, Left Return

Model#	(L)	(B)	(E)	(K)	(R)	(W)	Weight	Cube	Price
* APET243660L	60"	36"	24"	21"	24"	22"	57	2	\$418
* APET243666L	66"	36"	24"	21"	24"	24"	62	2	\$444
* APET243672L	72"	36"	24"	21"	24"	30"	68	2	\$459
* APET244260L	60"	42"	24"	24"	24"	21"	66	2	\$448
* APET244266L	66"	42"	24"	24"	24"	27"	73	2	\$474
* APET244272L	72"	42"	24"	24"	24"	33"	79	2	\$489

1 silver square grommet (top corner) standard. 3" clear from approach.
 See external stabilizer bar selection guide on P. 194.
 * 2 stabilizer bars are required on 60", 66" & 72" wide worksurfaces when supporting with left & right Double post leg, D-legs or T-legs

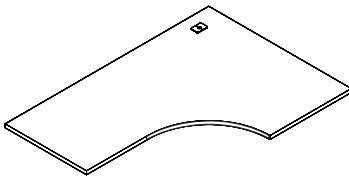

Extended Compu-Corner Worksurface, Right Return

Model#	(L)	(B)	(E)	(K)	(R)	(W)	Weight	Cube	Price
* APET243660R	60"	36"	24"	21"	24"	22"	57	2	\$418
* APET243666R	66"	36"	24"	21"	24"	24"	62	2	\$444
* APET243672R	72"	36"	24"	21"	24"	30"	68	2	\$459
* APET244260R	60"	42"	24"	24"	24"	21"	66	2	\$448
* APET244266R	66"	42"	24"	24"	24"	27"	72	2	\$474
* APET244272R	72"	42"	24"	24"	24"	33"	79	2	\$489

1 silver square grommet (top corner) standard. 3" clear from approach.
 See external stabilizer bar selection guide on page 194.
 * 2 stabilizer bars are required on 60", 66" & 72" wide worksurfaces when supporting with left & right Double post leg, D-legs or T-legs

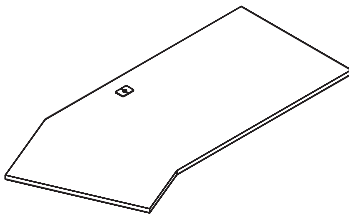
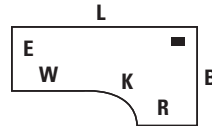

Compu-Corner Angle Worksurface, Left

Model#	(L)	(B)	(E)	(K)	(W)	Weight	Cube	Price
APAT2472L	72"	24"	20"	48"	15"	59	2	\$501
APAT3072L	72"	30"	20"	48"	15"	68	2	\$538

1 silver square grommet (top center) standard. 3" clear from approach.
 See external stabilizer bar selection guide on P. 194.
 * 2 stabilizer bars are required when supporting with left & right Double post leg, D-legs or T-legs

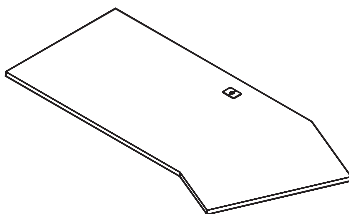

Compu-Corner Angle Worksurface, Right

Model#	(L)	(B)	(E)	(K)	(W)	Weight	Cube	Price
APAT2472R	72"	24"	20"	48"	15"	59	2	\$501
APAT3072R	72"	30"	20"	48"	15"	68	2	\$538

1 silver square grommet (top center) standard. 3" clear from approach.
 See external stabilizer bar selection guide on P. 194.
 * 2 stabilizer bars are required when supporting with left & right Double post leg, D-legs or T-legs

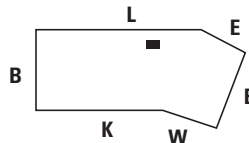

apex series

Worksurfaces

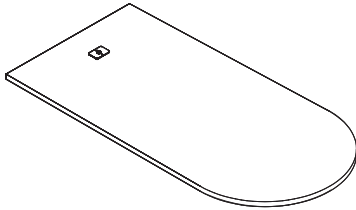

Bullet Worksurface, Left

Model#	Depth	Width	Height	Weight	Cube	Price
¹⁵ * APBD3060L	30"	60"	1"	47	2	\$418
* APBD3066L	30"	66"	1"	52	2	\$442
¹⁵ * APBD3072L	30"	72"	1"	57	2	\$459
* APBD3672L	36"	72"	1"	68	2	\$495

1 left silver square grommet (top center) standard. 3" clear from approach.
 See external stabilizer bar selection guide on p. 192.
 * 2 stabilizer bars are required on 60", 66" & 72" wide worksurfaces when supporting with left & right Double post leg, D-legs or T-legs

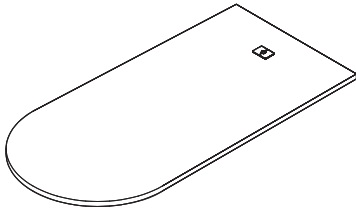

Bullet Worksurface, Right

Model#	Depth	Width	Height	Weight	Cube	Price
¹⁵ * APBD3060R	30"	60"	1"	47	2	\$418
* APBD3066R	30"	66"	1"	52	2	\$442
¹⁵ * APBD3072R	30"	72"	1"	57	2	\$459
* APBD3672R	36"	72"	1"	68	2	\$495

1 right silver square grommet (top center) standard. 3" clear from approach.
 See external stabilizer bar selection guide on p. 192.
 * 2 stabilizer bars are required on 60", 66" & 72" wide worksurfaces when supporting with left & right Double post leg, D-legs or T-legs

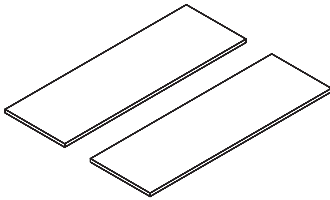

Two Rectangular Worksurfaces for Shared Supports

Model#	Depth	Width	Height	Weight	Cube	Price
APRECH4848	48"	48"	1"	50	2	\$477
¹⁵ APRECH4860	48"	60"	1"	63	2	\$632
APRECH4866	48"	66"	1"	69	2	\$675
¹⁵ APRECH4872	48"	72"	1"	75	2	\$704
APRECH6048	60"	48"	1"	65	2	\$522
APRECH6060	60"	60"	1"	82	3	\$692
APRECH6066	60"	66"	1"	90	3	\$751
APRECH6072	60"	72"	1"	98	3	\$787

* To be used with middle troughs, see p. 207. 2 stabilizers are required on tops of 54" or greater.
 See external stabilizer bar selection guide on p. 192.

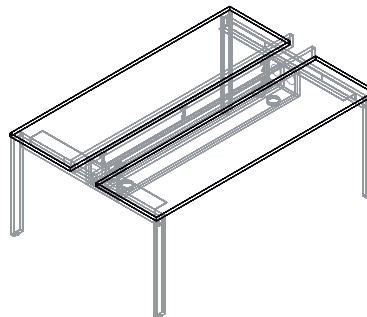

apex series

Worksurfaces

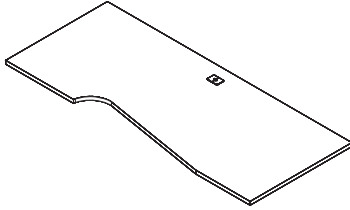

Compu-Corner Saddle Worksurface, Left Return

Model#	(L)	(B)	(K)	(R)	(W)	Weight	Cube	Price
APST247220L	72"	24"	36"	20"	16"	45	1	\$472
APST247224L	72"	24"	32"	24"	16"	45	1	\$477
APST307220L	72"	30"	36"	20"	16"	57	2	\$501
APST307224L	72"	30"	32"	24"	16"	57	2	\$530

1 silver square grommet (top center) standard. 3" clear from approach.
See external stabilizer bar selection guide on p. 192.
* 2 stabilizer bars are required on 60", 66" & 72" wide worksurfaces when supporting with left & right Double post leg, D-legs or T-legs

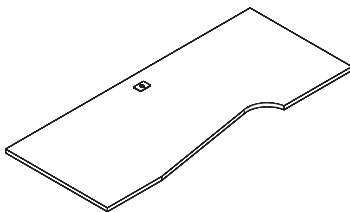

Compu-Corner Saddle Worksurface, Right Return

Model#	(L)	(B)	(K)	(R)	(W)	Weight	Cube	Price
APST247220R	72"	24"	36"	20"	16"	45	1	\$472
APST247224R	72"	24"	32"	24"	16"	45	1	\$477
APST307220R	72"	30"	36"	20"	16"	57	2	\$501
APST307224R	72"	30"	32"	24"	16"	57	2	\$530

1 silver square grommet (top center) standard. 3" clear from approach.
See external stabilizer bar selection guide on p. 192.
* 2 stabilizer bars are required on 60", 66" & 72" wide worksurfaces when supporting with left & right Double post leg, D-legs or T-legs

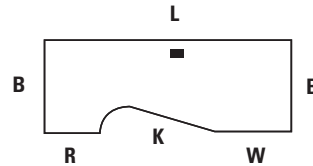

Worksurfaces for Support Pedestals

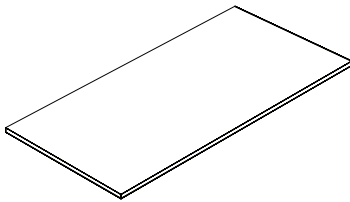

Rectangular Worksurface, Tops for Supporting Pedestals

Model#	Depth	Width	Height	Fits Pedestal	Weight	Cube	Price
APT0P2016	20"	16"	1"	BBF, FF	9	1	\$131
APT0P2416	24"	16"	1"	BBF, FF	9	1	\$131
APT0P3016	30"	16"	1"	BBF, FF	13	1	\$131
APT0P2030	20"	30"	1"	HDC	16	1	\$193
APT0P2031	20"	31"	1"	LF, PLF	17	1	\$193
APT0P2430	24"	30"	1"	HDC	16	1	\$205
APT0P2431	24"	31"	1"	LF, PLF	20	1	\$212
15 APT0P2036	20"	36"	1"	LF, HDC	19	1	\$200
15 APT0P2436	24"	36"	1"	LF, HDC	23	1	\$212
APT0P2062	20"	62"	1"	2-LF, 2-PLF	33	1	\$301
APT0P2462	24"	62"	1"	2-LF, 2-PLF	39	1	\$318
15 APT0P2072	20"	72"	1"	2-LF, 2-HDC	45	1	\$337
15 APT0P2472	24"	72"	1"	2-LF, 2-HDC	45	1	\$352

* Tops ship separately for field install, brackets are included. Tops only can be purchase for own use.

apex series

Worksurfaces and Privacy Panels

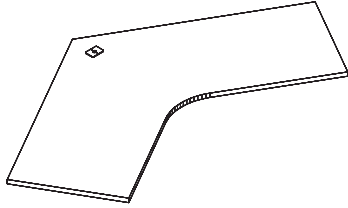

Corner Worksurface, Silver Square Grommet

Model#	Depth	Width	Height	Weight	Cube	Price
APCCU424224	24"/24"	42x42"	1"	84	2	\$670
APCCU424230	30"/30"	42x42"	1"	94	2	\$710
APCCU484824	24"/24"	48x48"	1"	104	3	\$740
APCCU484830	30"/30"	48x48"	1"	115	3	\$780
APCCU545424	24"/24"	54x54"	1"	125	3	\$810
APCCU545430	30"/30"	54x54"	1"	137	3	\$850

Corner silver square grommet standard.

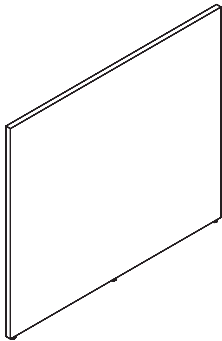

Privacy Panel

Model#	Depth	Width	Height	Weight	Cube	Price
APPANEL4236	1"	42"	36"	42	1	\$445
APPANEL4836	1"	48"	36"	48	1	\$465
APPANEL5436	1"	54"	36"	54	2	\$480
APPANEL4242	1"	42"	42"	49	2	\$465
APPANEL4842	1"	48"	42"	56	2	\$490
APPANEL5442	1"	54"	42"	63	2	\$510
APPANEL4248	1"	42"	48"	56	2	\$490
APPANEL4848	1"	48"	48"	64	2	\$515
APPANEL5448	1"	54"	48"	72	2	\$540

No predrill holes. Ships separately for field install, brackets are included.
Use for corner and other worksurfaces.

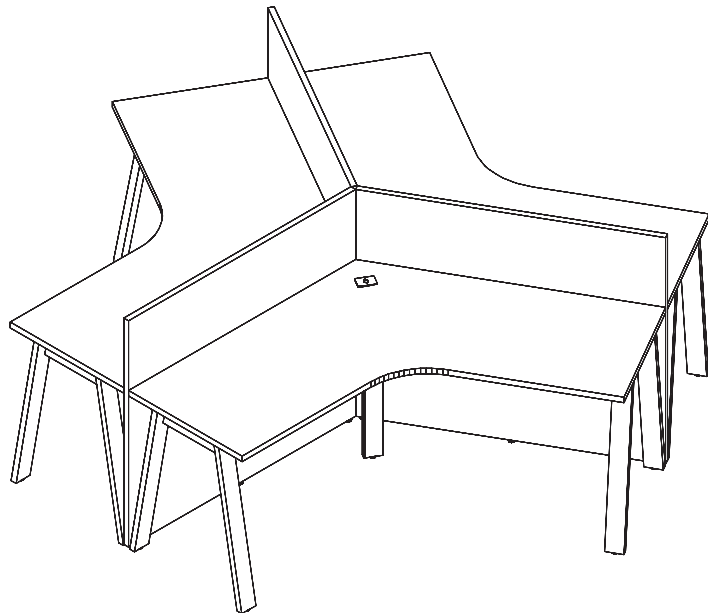

apex series

Support Pedestals

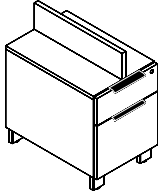

Supporting Box/File with Top Center Support (Face lock, APH1 handles)

Model#	Depth	Width	Height	Weight	Cube	Price
APPED A20 BF	20"	16"	28"	73	6	\$1,045
APPED A24 BF	24"	16"	28"	78	7	\$1,068
APPED A30 BF	30"	16"	28"	89	8	\$1,096

Top support to be installed flush with tops.
For flush pedestal with top specify location, add MMCUT3...\$155.

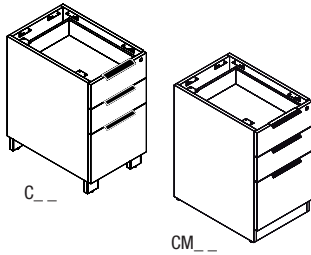

Supporting Box/Box/File, No Top (Face lock, APH1 handles)

Model#	Depth	Width	Height	Weight	Cube	Price
APPED C20 BBF	20"	16"	28"	77	6	\$1,117
APPED C24 BBF	24"	16"	28"	83	7	\$1,125
APPED C30 BBF	30"	16"	28"	92	8	\$1,153
APPED CM20 BBF	20"	16"	28"	77	6	\$ 733
APPED CM24 BBF	24"	16"	28"	83	7	\$ 756
APPED CM30 BBF	30"	16"	28"	92	8	\$ 789

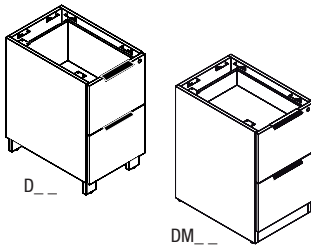

Supporting File/File, No Top (Face lock, APH1 handles)

Model#	Depth	Width	Height	Weight	Cube	Price
APPED D20 FF	20"	16"	28"	73	6	\$1,056
APPED D24 FF	24"	16"	28"	79	7	\$1,078
APPED D30 FF	30"	16"	28"	88	8	\$1,108
APPED DM20 FF	20"	16"	28"	73	6	\$ 710
APPED DM24 FF	24"	16"	28"	79	7	\$ 733
APPED DM30 FF	30"	16"	28"	88	8	\$ 766

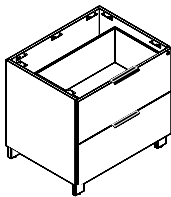

Supporting Lateral File, No Top (Face lock, APH1 handles)

Model#	Depth	Width	Height	Weight	Cube	Price
APPED LF2031	20"	31"	28"	111	11	\$1,301
APPED LF2036	20"	36"	28"	120	12	\$1,329
APPED LF2431	24"	31"	28"	118	13	\$1,340
APPED LF2436	24"	36"	28"	128	14	\$1,369

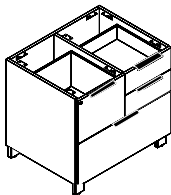

Supporting Personal Lateral File, No Top (Face lock, APH1 handles)

Model#	Depth	Width	Height	Weight	Cube	Price
APPED PLF2031	20"	31"	28"	124	11	\$1,420
APPED PLF2431	24"	31"	28"	132	13	\$1,454

* Box drawers do not lock, (1) lock locks file and lateral file drawer.

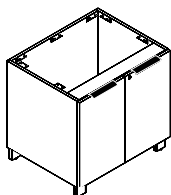

Supporting Hinged Door Cabinet, No Top (Face lock, APH1 handles)

Model#	Depth	Width	Height	Weight	Cube	Price
APPED HDC2030	20"	30"	28"	91	10	\$1,153
APPED HDC2036	20"	36"	28"	104	12	\$1,164
APPED HDC2430	24"	30"	28"	101	12	\$1,175
APPED HDC2436	24"	36"	28"	115	14	\$1,193

* 1 adjustable 3/4" shelf is standard.

apex series

Worksurface Supports

External Stabilizer Bar Specification Guide		Worksurface Width			
SUPPORT 1	SUPPORT 2	72"	66"	60"	54"
* A,D, DP-LEG	A,D, DP-LEG	* (2) APSB72	* (2) APSB66	* (2) APSB60	APSB54
* A,D, DP-LEG	T-LEG	* (2) APSB72	* (2) APSB66	* (2) APSB60	APSB54
A,D, DP-LEG	PEDESTAL (BBF or FF)	APSB60	APSB54	N/A	N/A
A,D, DP-LEG	LAT/PLF/HDC	N/A	N/A	N/A	N/A
T-LEG	T-LEG	APSB60	APSB54	N/A	N/A
T-LEG	PEDESTAL	APSB54	N/A	N/A	N/A
T-LEG	LAT/PLF/HDC	N/A	N/A	N/A	N/A
PEDESTAL	PEDESTAL	APSB54	N/A	N/A	N/A
PEDESTAL	LAT/PLF/HDC	N/A	N/A	N/A	N/A

* NOTE: 2 stabilizer bars are required on 60", 66" & 72" wide worksurfaces when supported by left or right double post leg, D-legs or T-legs. If a modesty panel (TFM or HPL) is being specified only one stabilizer bar is required, acrylic modesty requires 2 stabilizer bars.

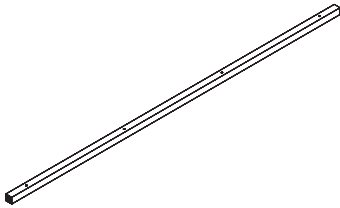

External Stabilizer Bar

Model#	Depth	Width	Height	Top Width	Weight	Cube	Price
APSB54	1"	38"	1"	54"	5	1	\$68
APSB60	1"	44"	1"	60"	6	1	\$74
APSB66	1"	50"	1"	66"	7	1	\$80
APSB72	1"	56"	1"	72"	8	1	\$85

* Reference stabilizer bar specification guide to determine stabilizer bar required. Stabilizer bars are recommended to be field installed 6" clear from approach side with #8 x 1" wood screws.

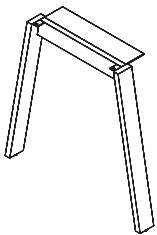

Apron Frame Leg, Silver Finish (Specify black or white finish)

Model#	Depth	Width	Height	Top Depth	Weight	Cube	Price
APOAL20	20"	6"	28"	20"	15	3	\$338
APOAL24	24"	6"	28"	24"	22	3	\$358
APOAL30	30"	6"	28"	30" & 36"	26	4	\$377
APOAL48	48"	6"	28"	48"	40	6	\$501
APOAL60	60"	6"	28"	60"	46	7	\$529

Silver legs are standard. For black leg upgrade add APULEGB, for white leg add APULEGW. NOTE: 2 stabilizer bars are required on 60", 66" & 72" wide worksurfaces when supporting with left & right Apron Frame Leg. This leg style cannot be used for conference tables.

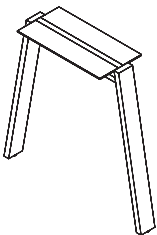

Shared Apron Frame Leg, Silver Finish (Specify black or white finish)

Model#	Depth	Width	Height	Top Depth	Weight	Cube	Price
APMAL20	20"	6"	28"	20"	26	3	\$430
APMAL24	24"	6"	28"	24"	32	4	\$460
APMAL30	30"	6"	28"	30" & 36"	36	5	\$482



Silver legs are standard. For black leg upgrade add APULEGB, for white leg add APULEGW. NOTE: 2 stabilizer bars are required on 60", 66" & 72" wide worksurfaces when supporting with left & right Shared Apron Frame Leg. This leg style cannot be used for conference tables.

apex series

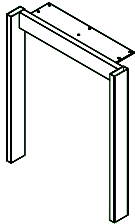
Worksurface Supports





Double Post Leg, Silver Finish (Specify black or white finish)

Model#	Depth	Width	Height	Top Depth	Weight	Cube	Price
APODPL20	20"	3"	28"	20"	15	3	\$302
 APODPL24	24"	3"	28"	24"	22	3	\$323
 APODPL30	30"	3"	28"	30" & 36"	26	4	\$346
 APODPL48	48"	3"	28"	48"	40	6	\$426
APODPL60	60"	3"	28"	60"	46	7	\$454

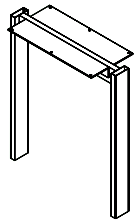
Silver legs are standard. For black leg upgrade add APULEGB, for white leg add APULEGW.
NOTE: 2 stabilizer bars are required on 60", 66" & 72" wide worksurfaces when supporting with left & right Double post leg.





Shared Double Post Leg, Silver Finish (Specify black or white finish)

Model#	Depth	Width	Height	Top Depth	Weight	Cube	Price
APDPML20	20"	3"	28"	20"	26	3	\$364
 APDPML24	24"	3"	28"	24"	32	4	\$402
 APDPML30	30"	3"	28"	30" & 36"	36	5	\$437

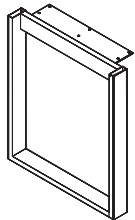
Silver legs are standard. For black leg upgrade add APULEGB, for white leg add APULEGW.
* Use to support 2 worksurfaces



D-Leg, Silver Finish (Specify black or white finish)

Model#	Depth	Width	Height	Top Depth	Weight	Cube	Price
APODL20	20"	3"	28"	20"	19	3	\$369
 APODL24	24"	3"	28"	24"	26	3	\$397
 APODL30	30"	3"	28"	30" & 36"	29	4	\$420
 APODL48	48"	3"	28"	48"	44	6	\$494
APODL60	60"	3"	28"	60"	50	7	\$545

Silver legs are standard. For black leg upgrade add APULEGB, for white leg add APULEGW.
NOTE: 2 stabilizer bars are required on 60", 66" & 72" wide worksurfaces when supporting with left & right D-Leg.

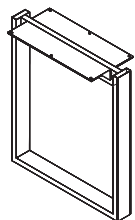

Shared D-Leg, Silver Finish (Specify black or white finish)

Model#	Depth	Width	Height	Top Depth	Weight	Cube	Price
APMDL20	20"	3"	28"	20"	28	3	\$454
 APMDL24	24"	3"	28"	24"	37	4	\$472
 APMDL30	30"	3"	28"	30" & 36"	40	5	\$505

Silver legs are standard. For black leg upgrade add APULEGB, for white leg add APULEGW.
* Use to support 2 worksurfaces
NOTE: 2 stabilizer bars are required on 60", 66" & 72" wide worksurfaces when supporting with left & right Shared D-Leg.



Single Post, Silver Finish (Specify black or white finish)

Model#	Depth	Width	Height	Weight	Cube	Price
 APSPL28	1"	3"	28"	6	1	\$131

Silver legs are standard. For black leg upgrade add APULEGB, for white leg add APULEGW.
Field install with #8 x 1" wood screws. Use for bullet tops or additional support under top.

apex series

Worksurface Supports

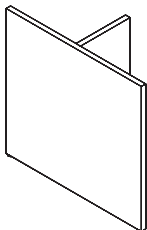
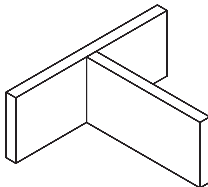
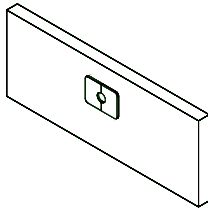
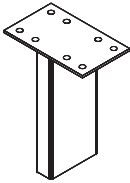
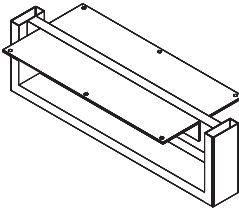
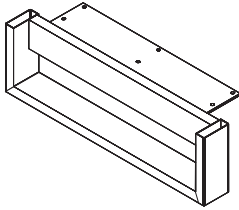

Short D-Leg, Silver Finish (Specify black or white finish)

Model#	Depth	Width	Height	Weight	Cube	Price
APOSDL20	20"	3"	6"	14	1	\$397
APOSDL24	24"	3"	6"	17	1	\$409
APOSDL30	30"	3"	6"	20	1	\$443

Silver legs are standard. For black leg upgrade add APULEGB, for white leg add APULEGW.

* Supports worksurface below tops and above low credenza.

Cannot be used when specifying modesty below worksurface.

NOTE: 2 stabilizer bars are required on 60", 66" & 72" wide worksurfaces when supporting with left & right Short D-Leg.

Short D-Leg Shared, Silver Finish (Specify black or white finish)

Model#	Depth	Width	Height	Weight	Cube	Price
APMSDL20	20"	3"	6"	23	1	\$378
APMSDL24	24"	3"	6"	26	1	\$397
APMSDL30	30"	3"	6"	29	1	\$437

Silver legs are standard. For black leg upgrade add APULEGB, for white leg add APULEGW.

* Use to support 2 worksurfaces above low credenzas.

Cannot be used when specifying modesty below worksurface.

NOTE: 2 stabilizer bars are required on 60", 66" & 72" wide worksurfaces when supporting with left & right Short D-Leg Shared.

Low Post Leg, Silver Finish (Specify black or white finish)

Model#	Depth	Width	Height	Weight	Cube	Price
APSP6	1"	3"	6"	5	1	\$57

Silver legs are standard. For black leg upgrade add APULEGB, for white leg add APULEGW.

* Supports worksurface below tops and above low credenza.

Field install with #8 x 1" wood screws

Low Credenza TFM Support

Model#	Depth	Width	Height	Weight	Cube	Price
APSLEG20	12"	1"	6"	4	1	\$80
APSLEG24	16"	1"	6"	4	1	\$85
APSLEG30	22"	1"	6"	5	1	\$90

Must be ordered when specifying modesty below worksurface.

Pin and cam connection to worksurface underside. Standard silver square grommet.

Support T-Leg, TFM (For low credenza)

Model#	Depth	Width	Height	Fits Top Depth	Weight	Cube	Price
¹⁵ APTLEG2406	16"	13"	6"	24"	4	1	\$130
¹⁵ APTLEG3006	22"	13"	6"	30"	5	1	\$137

Must be ordered when specifying modesty below worksurface.

Supports worksurface above low credenza, pin and cam connection to worksurface underside.

T-Leg (TFM leg)

Model#	Depth	Width	Height	Weight	Cube	Price
¹⁵ APTLEG24	24"	13"	28"	27	6	\$148
¹⁵ APTLEG30	30"	13"	28"	31	7	\$153

NOTE: 2 stabilizer bars are required on 60", 66" & 72" wide worksurfaces when supporting with left & right T-leg.

apex series

Worksurface Supports, Bases

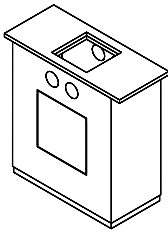

Square Panel Base (Hollow with access door)

Model#	Depth	Width	Height	Weight	Cube	Price
APASQWD1224	12"	24"	28"	60	5	\$ 955
APASQWD1230	12"	30"	28"	79	6	\$1,164

* Four grommet cutouts standard.
To be used with shared worksurfaces and wire management troughs.

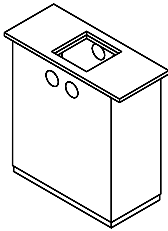

Square Panel Base (No door)

Model#	Depth	Width	Height	Weight	Cube	Price
APASQND1224	12"	24"	28"	57	5	\$579
APASQND1230	12"	30"	28"	76	6	\$648

Four grommet cutouts standard.
To be used with shared worksurfaces and wire management troughs.

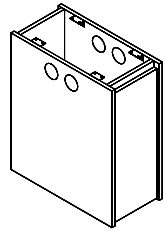

Square Panel Base (Hollow with end access door)

Model#	Depth	Width	Height	Weight	Cube	Price
¹⁵ APLEGM1224	12"	24"	28"	47	5	\$432
APLEGM1230	12"	30"	28"	56	6	\$528

Four grommet cutouts standard.
To be used with shared worksurfaces and wire management troughs.

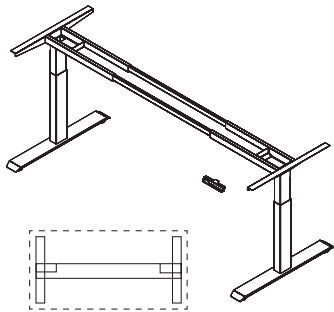

Adjustable Height Electrical Base

Model#	Base(D)	Base (W)	Height	Fits Top Size	Color	Weight	Cube	Price
¹⁵ MMLEGAHE24S	22"	47-72"	23 1/2-49"	24"D-72"W	Silver	64	1	\$1,366
MMLEGAHE24B	22"	47-72"	23 1/2-49"	24"D-72"W	Black	64	1	\$1,366
MMLEGAHE24W	22"	47-72"	23 1/2-49"	24"D-72"W	White	64	1	\$1,366
¹⁵ MMLEGAHE30S	28"	47-72"	23 1/2-49"	30"D-72"W	Silver	64	1	\$1,366
MMLEGAHE30B	28"	47-72"	23 1/2-49"	30"D-72"W	Black	64	1	\$1,366
MMLEGAHE30W	28"	47-72"	23 1/2-49"	30"D-72"W	White	64	1	\$1,366

2 Stage base.
Bases ship unassembled unless otherwise specified. For base functions see training section.

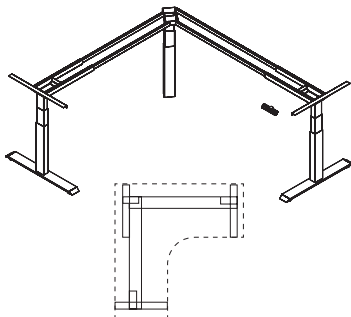

Adjustable Height Electrical L-Unit Base (Sit to stand, N/A in black)

Model#	Base(D)	Base (W)	Height	Fits Top Size	Color	Weight	Cube	Price
MMLEGAHEL24S	22"	48-72"	23 1/2-49"	24"D-72"W	Silver	112	1	\$2,337
MMLEGAHEL24W	22"	48-72"	23 1/2-49"	24"D-72"W	White	112	1	\$2,337
MMLEGAHEL30S	28"	48-72"	23 1/2-49"	30"D-72"W	Silver	112	1	\$2,337
MMLEGAHEL30W	28"	48-72"	23 1/2-49"	30"D-72"W	White	112	1	\$2,337

Bases ship unassembled unless otherwise specified. For base functions see training section. 3 Stage base.

apex series

Privacy Screens

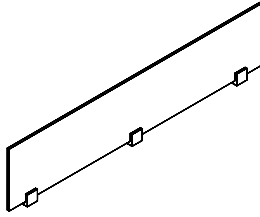

Frosted Acrylic Privacy Screen (3/8" thick acrylic)

Model#	Depth	Width	Height	Weight	Cube	Price
APPSU24	1"	17"	12"	4	1	\$188
APPSU30	1"	23"	12"	6	1	\$233
APPSU36	1"	29"	12"	7	1	\$304
APPSU42	1"	35"	12"	8	1	\$334
15 APPSU48	1"	41"	12"	9	1	\$409
APPSU54	1"	47"	12"	10	1	\$586
15 APPSU60	1"	53"	12"	11	1	\$591
APPSU66	1"	59"	12"	12	1	\$596
15 APPSU72	1"	65"	12"	13	1	\$602

* Privacy screens APPSU24 thru APPSU48 include two mounting clips.

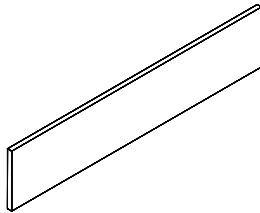

TFM Privacy Screen (1" thick)

Model#	Depth	Width	Height	Weight	Cube	Price
APPSUW2412	1"	17"	12"	8	1	\$ 88
APPSUW3012	1"	23"	12"	10	1	\$ 88
APPSUW3612	1"	29"	12"	12	1	\$103
APPSUW4212	1"	35"	12"	14	1	\$103
APPSUW4812	1"	41"	12"	15	1	\$114
APPSUW5412	1"	47"	12"	17	1	\$114
15 APPSUW6012	1"	53"	12"	19	1	\$130
APPSUW6612	1"	59"	12"	21	1	\$138
15 APPSUW7212	1"	65"	12"	23	1	\$138

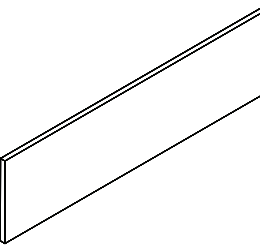

TFM Privacy Screen (1" thick)

Model#	Depth	Width	Height	Weight	Cube	Price
APPSUW2415	1"	17"	15"	10	1	\$177
APPSUW3015	1"	23"	15"	12	1	\$177
APPSUW3615	1"	29"	15"	15	1	\$204
APPSUW4215	1"	35"	15"	17	1	\$204
APPSUW4815	1"	41"	15"	19	1	\$230
APPSUW5415	1"	47"	15"	22	1	\$230
15 APPSUW6015	1"	53"	15"	24	1	\$259
APPSUW6615	1"	59"	15"	26	1	\$278
15 APPSUW7215	1"	65"	15"	27	1	\$278

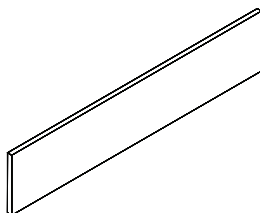

HPL Privacy Screen (1" thick)

Model#	Depth	Width	Height	Weight	Cube	Price
APPSUHP2412	1"	17"	12"	8	1	\$130
APPSUHP3012	1"	23"	12"	10	1	\$130
APPSUHP3612	1"	29"	12"	12	1	\$157
APPSUHP4212	1"	35"	12"	14	1	\$157
APPSUHP4812	1"	41"	12"	15	1	\$191
APPSUHP5412	1"	47"	12"	17	1	\$191
APPSUHP6012	1"	53"	12"	19	1	\$232
APPSUHP6612	1"	59"	12"	21	1	\$253
APPSUHP7212	1"	65"	12"	23	1	\$253

apex series

Privacy Screens

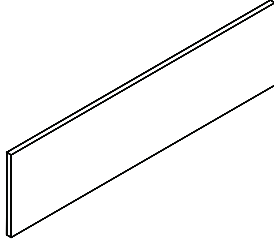

HPL Privacy Screen (1" thick)

Model#	Depth	Width	Height	Weight	Cube	Price
APPSUHP2415	1"	17"	15"	10	1	\$259
APPSUHP3015	1"	23"	15"	12	1	\$259
APPSUHP3615	1"	29"	15"	15	1	\$313
APPSUHP4215	1"	35"	15"	17	1	\$313
APPSUHP4815	1"	41"	15"	19	1	\$381
APPSUHP5415	1"	47"	15"	22	1	\$381
APPSUHP6015	1"	53"	15"	24	1	\$463
APPSUHP6615	1"	59"	15"	26	1	\$504
APPSUHP7215	1"	65"	15"	29	1	\$504

Privacy screens location: Center (left to right) is standard on worksurfaces. For custom location, must be specified. Add MMCUT3...\$148 list.

Privacy Screen Extensions

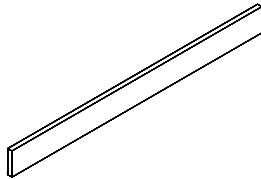

TFM Extension (1" thick) for Frosted Acrylic Privacy Screens

Model#	Depth	Width	Height	Weight	Cube	Price
APPSUW2406	1"	17"	6"	3	1	\$ 88
APPSUW3006	1"	23"	6"	4	1	\$ 88
APPSUW3606	1"	29"	6"	5	1	\$103
APPSUW4206	1"	35"	6"	6	1	\$103
APPSUW4806	1"	41"	6"	7	1	\$114
APPSUW5406	1"	47"	6"	8	1	\$114
APPSUW6006	1"	53"	6"	9	1	\$130
APPSUW6606	1"	59"	6"	10	1	\$138
APPSUW7206	1"	65"	6"	11	1	\$138

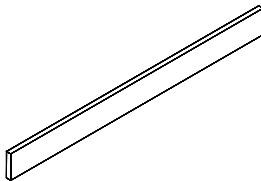

HPL Extension (1" thick) for Frosted Acrylic Privacy Screens

Model#	Depth	Width	Height	Weight	Cube	Price
APPSUHP2406	1"	17"	6"	3	1	\$130
APPSUHP3006	1"	23"	6"	4	1	\$130
APPSUHP3606	1"	29"	6"	5	1	\$157
APPSUHP4206	1"	35"	6"	6	1	\$157
APPSUHP4806	1"	41"	6"	7	1	\$191
APPSUHP5406	1"	47"	6"	8	1	\$191
APPSUHP6006	1"	53"	6"	9	1	\$232
APPSUHP6606	1"	59"	6"	10	1	\$253
APPSUHP7206	1"	65"	6"	11	1	\$253

apex series

Modesty Panels

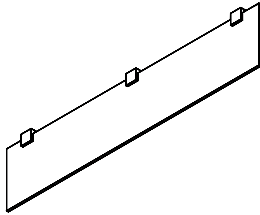

Frosted Acrylic Modesty (3/8" thick acrylic)

Model#	Depth	Width	Height	Weight	Cube	Price
APPSL24	1"	17"	12"	4	1	\$188
APPSL30	1"	23"	12"	6	1	\$233
APPSL36	1"	29"	12"	7	1	\$304
APPSL42	1"	35"	12"	8	1	\$334
15 APPSL48	1"	41"	12"	9	2	\$409
APPSL54	1"	47"	12"	10	2	\$586
15 APPSL60	1"	53"	12"	11	2	\$591
APPSL66	1"	59"	12"	12	2	\$596
15 APPSL72	1"	65"	12"	13	2	\$602

* Modesties APPSL24 thru APPSL48 include 2 mounting clips.

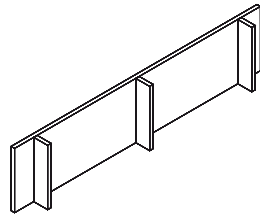

TFM Modesty (3/4" thick)

Model#	Depth	Width	Height	Weight	Cube	Price
APPSLW24	4"	17"	12"	7	1	\$ 88
APPSLW30	4"	23"	12"	8	1	\$ 88
APPSLW36	4"	29"	12"	10	1	\$103
APPSLW42	4"	35"	12"	11	1	\$103
APPSLW48	4"	41"	12"	13	2	\$114
APPSLW54	4"	47"	12"	15	2	\$114
15 APPSLW60	4"	53"	12"	16	2	\$130
APPSLW66	4"	59"	12"	18	2	\$138
15 APPSLW72	4"	65"	12"	19	2	\$138

* 3/4" thick TFM. Modesties APPSLW24 thru APPSLW48 include 2 vertical supports.

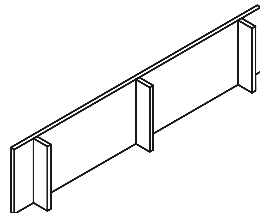

HPL Modesty (3/4" thick)

Model#	Depth	Width	Height	Weight	Cube	Price
APPSLHP24	4"	17"	12"	7	1	\$130
APPSLHP30	4"	23"	12"	8	1	\$130
APPSLHP36	4"	29"	12"	10	1	\$157
APPSLHP42	4"	35"	12"	11	1	\$157
APPSLHP48	4"	41"	12"	13	2	\$191
APPSLHP54	4"	47"	12"	15	2	\$191
APPSLHP60	4"	53"	12"	16	2	\$232
APPSLHP66	4"	59"	12"	18	2	\$253
APPSLHP72	4"	65"	12"	19	2	\$253

* 3/4" thick HPL. Modesties APPSLHP24 thru APPSLHP48 include 2 vertical supports.

Modesty Panel Standard Location:

Center left to right and flush to approach side is standard under worksurfaces, except 36"D tops, inset is 6".

For custom location, must be specified. Add MMCUT3...\$155 ea.

apex series

Low Credenzas

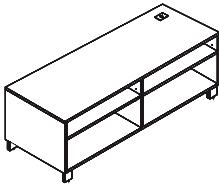

Left Open Credenza, Silver Feet, 2-Adjustable shelves, 4 Grommets (Specify black or white feet)

Model#	Depth	Width	Height	Weight	Cube	Price
APDO2048L	20"	48"	22"	115	13	\$1,239
APDO2060L	20"	60"	22"	136	16	\$1,448
APDO2066L	20"	66"	22"	146	17	\$1,459
APDO2072L	20"	72"	22"	156	19	\$1,500
APDO2448L	24"	48"	22"	132	15	\$1,306
APDO2460L	24"	60"	22"	156	19	\$1,500
APDO2466L	24"	66"	22"	167	21	\$1,533
APDO2472L	24"	72"	22"	179	22	\$1,579

Silver feet are standard. For black feet upgrade add APUFEETB, for white feet add APUFEETW.
* Standard right silver square grommet on top, modesty, adjustable shelf and bottom shelf.

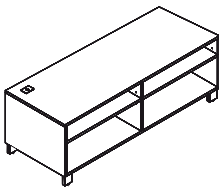

Right Open Credenza, Silver Feet, 2-Adjustable Shelves, 4 Grommets (Specify black or white feet)

Model#	Depth	Width	Height	Weight	Cube	Price
APDO2048R	20"	48"	22"	115	13	\$1,239
APDO2060R	20"	60"	22"	136	16	\$1,448
APDO2066R	20"	66"	22"	147	17	\$1,459
APDO2072R	20"	72"	22"	156	19	\$1,500
APDO2448R	24"	48"	22"	132	15	\$1,306
APDO2460R	24"	60"	22"	156	19	\$1,500
APDO2466R	24"	66"	22"	167	21	\$1,533
APDO2472R	24"	72"	22"	179	22	\$1,579

Silver feet are standard. For black feet upgrade add APUFEETB, for white feet add APUFEETW.
* Standard left silver square grommet on top, modesty, adjustable shelf and bottom shelf.

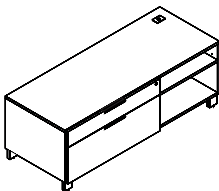

Left Single Box/Lateral Credenza, Silver Feet, Locking, 1-Adjustable shelf, 4 Grommets (Specify black or white feet)

Model#	Depth	Width	Height	Weight	Cube	Price
APSBL2048L	20"	48"	22"	147	13	\$1,653
¹⁵ APSBL2060L	20"	60"	22"	165	16	\$1,726
APSBL2066L	20"	66"	22"	173	17	\$1,761
¹⁵ APSBL2072L	20"	72"	22"	182	19	\$1,794
APSBL2448L	24"	48"	22"	161	15	\$1,715
¹⁵ APSBL2460L	24"	60"	22"	181	19	\$1,817
APSBL2466L	24"	66"	22"	191	21	\$1,874
¹⁵ APSBL2472L	24"	72"	22"	201	22	\$1,930

Silver feet are standard. For black feet upgrade add APUFEETB, for white feet add APUFEETW.
* Standard right silver square grommet on top, modesty, adjustable shelf and bottom shelf.
31" w Box/Lateral file on 48" w credenzas only.

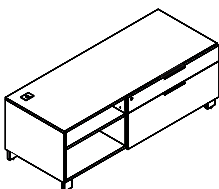

Right Single Box/Lateral Credenza, Silver Feet, Locking, 1-Adjustable Shelf, 4 Grommets (Specify black or white feet)

Model#	Depth	Width	Height	Weight	Cube	Price
APSBL2048R	20"	48"	22"	147	13	\$1,653
¹⁵ APSBL2060R	20"	60"	22"	165	16	\$1,726
APSBL2066R	20"	66"	22"	173	17	\$1,761
¹⁵ APSBL2072R	20"	72"	22"	182	19	\$1,794
APSBL2448R	24"	48"	22"	161	15	\$1,715
¹⁵ APSBL2460R	24"	60"	22"	181	19	\$1,817
APSBL2466R	24"	66"	22"	191	21	\$1,874
¹⁵ APSBL2472R	24"	72"	22"	201	22	\$1,930

Silver feet are standard. For black feet upgrade add APUFEETB, for white feet add APUFEETW.
* Standard left silver square grommet on top, modesty, adjustable shelf and bottom shelf.
31" w Box/Lateral file on 48" w credenzas only.

apex series

Low Credenzas

Left Single Lateral Credenza, Silver Feet, Locking, 1-Adjustable Shelf, 4 Grommets (Specify black or white feet)

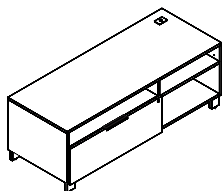

Model#	Depth	Width	Height	Weight	Cube	Price
APSL02048L	20"	48"	22"	142	13	\$1,562
APSL02060L	20"	60"	22"	163	16	\$1,743
APSL02066L	20"	66"	22"	173	17	\$1,777
APSL02072L	20"	72"	22"	183	19	\$1,817
APSL02448L	24"	48"	22"	159	15	\$1,618
APSL02460L	24"	60"	22"	184	19	\$1,817
APSL02466L	24"	66"	22"	195	21	\$1,863
APSL02472L	24"	72"	22"	207	22	\$1,902

Silver feet are standard. For black feet upgrade add APUFEETB, for white feet add APUFEETW.
* Standard left silver square grommet on top, modesty, adjustable shelf and bottom shelf.
31" w Box/Lateral file on 48" w credenzas only.

Right Single Lateral Credenza, Silver Feet, Locking, 1-Adjustable Shelf, 4 Grommets (Specify black or white feet)

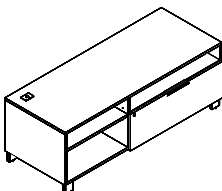

Model#	Depth	Width	Height	Weight	Cube	Price
APSL02048R	20"	48"	22"	142	13	\$1,562
APSL02060R	20"	60"	22"	163	16	\$1,743
APSL02066R	20"	66"	22"	173	17	\$1,777
APSL02072R	20"	72"	22"	183	19	\$1,817
APSL02448R	24"	48"	22"	159	15	\$1,618
APSL02460R	24"	60"	22"	184	19	\$1,817
APSL02466R	24"	66"	22"	195	21	\$1,863
APSL02472R	24"	72"	22"	207	22	\$1,902

Silver feet are standard. For black feet upgrade add APUFEETB, for white feet add APUFEETW.
* Standard left silver square grommet on top, modesty, adjustable shelf and bottom shelf.
31" w Box/Lateral file on 48" w credenzas only.

Left Double Lateral Credenza, Silver Feet, Locking, 2 Grommets (Specify black or white feet)

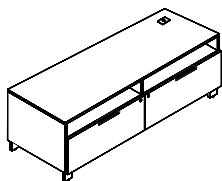

Model#	Depth	Width	Height	Weight	Cube	Price
APDOL2061L	20"	61"	22"	196	16	\$1,930
APDOL2072L	20"	72"	22"	219	19	\$1,987
APDOL2461L	24"	61"	22"	218	19	\$2,038
APDOL2472L	24"	72"	22"	244	22	\$2,078

Silver feet are standard. For black feet upgrade add APUFEETB, for white feet add APUFEETW.
* Standard right silver square grommet on top & modesty.

Right Double Lateral Credenza, Silver Feet, Locking, 2 Grommets (Specify black or white feet)

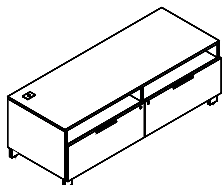

Model#	Depth	Width	Height	Weight	Cube	Price
APDOL2061R	20"	61"	22"	196	16	\$1,930
APDOL2072R	20"	72"	22"	219	19	\$1,987
APDOL2461R	24"	61"	22"	218	19	\$2,038
APDOL2472R	24"	72"	22"	244	22	\$2,078

Silver feet are standard. For black feet upgrade add APUFEETB, for white feet add APUFEETW.
* Standard left silver square grommet on top & modesty.

apex series

Freestanding Storage

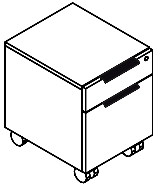

Mobile Pedestal (Box/File, Locking)

Model#	Depth	Width	Height	Weight	Cube	Price
APPEDAX20BF	20"	16"	22"	73	5	\$891
APPEDAX24BF	24"	16"	22"	78	7	\$914

* Seating weight capacity 175lbs.

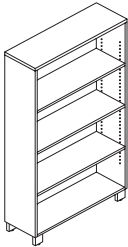

Bookcase, Silver Feet (Specify black or white feet)

Model#	Depth	Width	Height	# of Shelves	Weight	Cube	Price
APBC30	12"	36"	29"	1	66	8	\$627
APBC54	12"	36"	54"	2	107	14	\$803
APBC65	12"	36"	65"	3	137	17	\$944

Silver feet are standard. For black feet upgrade add APUFEETB, for white feet add APUFEETW.

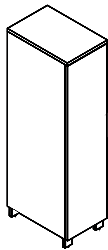

Left Single Storage Cabinet, Silver Feet (Specify black or white feet)

Model#	Depth	Width	Height	# of Shelves	Weight	Cube	Price
APSTS2054L	20"	16"	54"	2	112	10	\$1,402
APSTS2065L	20"	16"	65"	3	135	13	\$1,477
APSTS2454L	24"	16"	54"	2	126	12	\$1,471
APSTS2465L	24"	16"	65"	3	151	15	\$1,562

Silver feet are standard. For black feet upgrade add APUFEETB, for white feet add APUFEETW. Optional lock available, add MMFL...\$78.

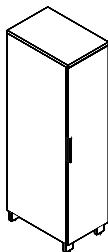

Right Single Storage Cabinet, Silver Feet (Specify black or white feet)

Model#	Depth	Width	Height	# of Shelves	Weight	Cube	Price
APSTS2054R	20"	16"	54"	2	112	10	\$1,402
APSTS2065R	20"	16"	65"	3	135	13	\$1,477
APSTS2454R	24"	16"	54"	2	126	12	\$1,471
APSTS2465R	24"	16"	65"	3	151	15	\$1,562

Silver feet are standard. For black feet upgrade add APUFEETB, for white feet add APUFEETW. Optional lock available, add MMFL...\$78.

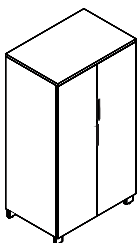

Double Storage Cabinet, Silver Feet (Specify black or white feet)

Model#	Depth	Width	Height	# of Shelves	Weight	Cube	Price
APDST2054	20"	36"	54"	2	188	23	\$1,704
APDST2065	20"	36"	65"	3	228	28	\$1,846
APDST2454	24"	36"	54"	2	209	27	\$1,777
APDST2465	24"	36"	65"	3	253	33	\$1,920

Silver feet are standard. For black feet upgrade add APUFEETB, for white feet add APUFEETW. Optional lock available, add MMFL...\$78.

apex series

Freestanding Storage

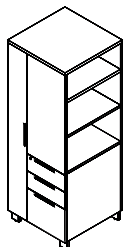

Left Personal Bookcase Storage Cabinet,
Silver Feet, Box/Box/File, Locking (Specify black or white feet)

Model#	Depth	Width	Height	# of Shelves	Weight	Cube	Price
APPBSC2054L	20"	24"	54"	3	178	15	\$1,636
APPBSC2065L	20"	24"	65"	5	208	19	\$1,698
APPBSC2454L	24"	24"	54"	3	198	18	\$1,658
APPBSC2465L	24"	24"	65"	5	229	22	\$1,732

Silver feet are standard. For black feet upgrade add APUFEETB, for white feet add APUFEETW.
* No coat rack. 2 Adjustable shelves on long compartment on 54"H, and 3-adjustable shelves on 65"H.
Optional face lock for hinged door available, add MMFL...\$78.

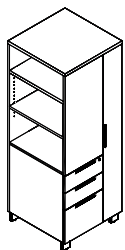

Right Personal Bookcase Storage Cabinet,
Silver Feet, Box/Box/File, Locking (Specify black or white feet)

Model#	Depth	Width	Height	# of Shelves	Weight	Cube	Price
APPBSC2054R	20"	24"	54"	3	178	15	\$1,636
APPBSC2065R	20"	24"	65"	5	208	19	\$1,698
APPBSC2454R	24"	24"	54"	3	198	18	\$1,658
APPBSC2465R	24"	24"	65"	5	229	22	\$1,732

Silver feet are standard. For black feet upgrade add APUFEETB, for white feet add APUFEETW.
* No coat rack. 2 Adjustable shelves on long compartment on 54"H, and 3-adjustable shelves on 65"H.
Optional face lock for hinged door available, add MMFL...\$78.

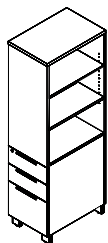

Left Single Personal Bookcase Cabinet,
Silver Feet, Box/Box/File, Locking (Specify black or white feet)

Model#	Depth	Width	Height	# of Shelves	Weight	Cube	Price
APBCPS2054L	20"	16"	54"	1	126	10	\$1,538
APBCPS2065L	20"	16"	65"	2	143	13	\$1,585
APBCPS2454L	24"	16"	54"	1	137	12	\$1,618
APBCPS2465L	24"	16"	65"	2	157	15	\$1,669

Silver feet are standard. For black feet upgrade add APUFEETB, for white feet add APUFEETW.

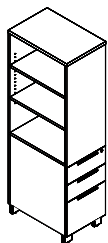

Right Single Personal Bookcase Cabinet,
Silver Feet, Box/Box/File, Locking (Specify black or white feet)

Model#	Depth	Width	Height	# of Shelves	Weight	Cube	Price
APBCPS2054R	20"	16"	54"	1	126	10	\$1,538
APBCPS2065R	20"	16"	65"	2	143	13	\$1,585
APBCPS2454R	24"	16"	54"	1	137	12	\$1,618
APBCPS2465R	24"	16"	65"	2	157	15	\$1,669

Silver feet are standard. For black feet upgrade add APUFEETB, for white feet add APUFEETW.

apex series

Freestanding Storage

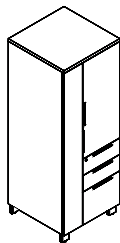

Left Personal Wardrobe Cabinet,
Silver Feet, Box/Box/File, Locking (Specify black or white Feet)

Model#	Depth	Width	Height	# of Shelves	Weight	Cube	Price
APWCP2454L	24"	24"	54"	1	208	18	\$1,686
APWCP2465L	24"	24"	65"	2	239	22	\$1,766

Silver feet are standard. For black feet upgrade add APUFEETB, for white feet add APUFEETW.
* Coat rack bar in long compartment included.
Optional face lock for hinged door available (two required), add MMFL...\$78/ea.

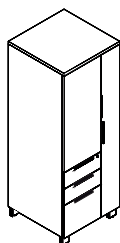

Right Personal Wardrobe Cabinet,
Silver Feet, Box/Box/File, Locking (Specify black or white Feet)

Model#	Depth	Width	Height	# of Shelves	Weight	Cube	Price
APWCP2454R	24"	24"	54"	1	208	18	\$1,686
APWCP2465R	24"	24"	65"	2	239	22	\$1,766

Silver feet are standard. For black feet upgrade add APUFEETB, for white feet add APUFEETW.
* Coat rack bar in long compartment included.
Optional face lock for hinged door available (two required), add MMFL...\$78/ea.



Left Single Storage Cabinet,
Silver Feet, Box/Box/File, Locking (Specify black or white Feet)

Model#	Depth	Width	Height	# of Shelves	Weight	Cube	Price
APBCV2054L	20"	16"	54"	1	136	10	\$1,693
APBCV2065L	20"	16"	65"	2	153	13	\$1,761
APBCV2454L	24"	16"	54"	1	147	12	\$1,766
APBCV2465L	24"	16"	65"	2	167	15	\$1,817

Silver feet are standard. For black feet upgrade add APUFEETB, for white feet add APUFEETW.
Optional face lock for hinged door available, add MMFL...\$78.



Right Single Storage Cabinet,
Silver Feet, Box/Box/File, Locking (Specify black or white Feet)

Model#	Depth	Width	Height	# of Shelves	Weight	Cube	Price
APBCV2054R	20"	16"	54"	1	136	10	\$1,693
APBCV2065R	20"	16"	65"	2	153	13	\$1,761
APBCV2454R	24"	16"	54"	1	147	12	\$1,766
APBCV2465R	24"	16"	65"	2	167	15	\$1,817

Silver feet are standard. For black feet upgrade add APUFEETB, for white feet add APUFEETW.
Optional face lock for hinged door available, add MMFL...\$78.

apex series

Overhead Storage

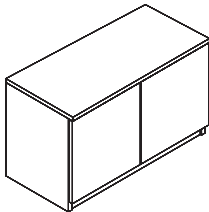
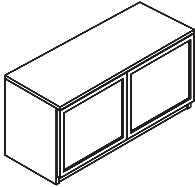
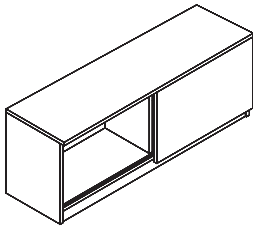
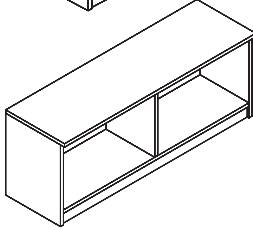
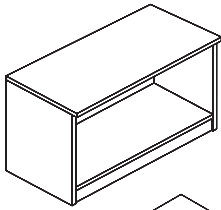

Wall Mount Cabinet, No Doors, with Fascia

Model#	Depth	Width	Height	Weight	Cube	Price
APCFOH030	14 3/4"	30"	18 1/2"	47	5	\$540
APCFOH036	14 3/4"	36"	18 1/2"	53	6	\$642
APCFOH042	14 3/4"	42"	18 1/2"	63	7	\$744
APCFOH048	14 3/4"	48"	18 1/2"	69	8	\$789

Optional tasklight APTSKLTX24...add \$192. 42"W & 48"W cabinet has center divider.
Requires professional installation and must be mounted to wall stud.
35lb. weight capacity.

Wall Mount Cabinet with One Sliding Door, with Fascia

Model#	Depth	Width	Height	Weight	Cube	Price
APCFOHS30	14 3/4"	30"	18 1/2"	58	5	\$ 749
APCFOHS36	14 3/4"	36"	18 1/2"	65	6	\$ 852
APCFOHS42	14 3/4"	42"	18 1/2"	71	7	\$ 955
APCFOHS48	14 3/4"	48"	18 1/2"	78	8	\$1,017

* No lock available.
Optional tasklight APTSKLTX24...add \$192.
Requires professional installation and must be mounted to wall stud.
35lb. weight capacity.

Wall Mount Cabinet with Frosted Glass Doors, with Fascia

Model#	Depth	Width	Height	Weight	Cube	Price
APCFOHG36	14 3/4"	36"	18 1/2"	63	6	\$977

* No lock available.
Optional tasklight APTSKLTX24...add \$192.
Requires professional installation and must be mounted to wall stud.
35lb. weight capacity.

Wall Mount Cabinet with Laminate Hinged Doors, with Fascia

Model#	Depth	Width	Height	# of Doors	Weight	Cube	Price
APCFOHD30	14 3/4"	30"	18 1/2"	2	58	5	\$789
APCFOHD36	14 3/4"	36"	18 1/2"	2	67	6	\$812
APCFOHD42	14 3/4"	42"	18 1/2"	2	79	7	\$932
APCFOHD48	14 3/4"	48"	18 1/2"	4	87	8	\$960

Optional tasklight APTSKLTX24...add \$192.
Optional face lock available (two required for 42" & 48" wide) add MMFL...\$78 each.
Requires professional installation and must be mounted to wall stud.
35lb. weight capacity.

apex series

Hutches

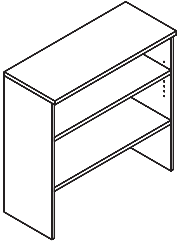

Bookcase Hutch, 1-Fixed and 1-Adjustable Shelf

Model#	Depth	Width	Height	Weight	Cube	Price
APBCH36	14"	36"	36"	79	11	\$449

Bottom clearance 12"H.

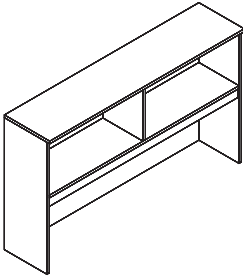

Hutch, No Doors, with Fascia

Model#	Depth	Width	Height	Weight	Cube	Price
APH36ND	14"	36"	36"	71	11	\$596
APH42ND	14"	42"	36"	84	13	\$664
APH48ND	14"	48"	36"	92	14	\$733
APH54ND	14"	54"	36"	100	16	\$766
APH60ND	14"	60"	36"	109	18	\$801
APH66ND	14"	66"	36"	116	20	\$847
APH72ND	14"	72"	36"	125	21	\$891

Optional tasklight APTSKLTX24...add \$192.
Bottom clearance 17 1/4" from fascia.

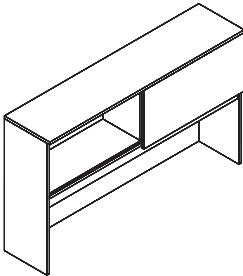

Hutch with One Sliding Door, with Fascia

Model#	Depth	Width	Height	Weight	Cube	Price
APH36SD	14"	36"	36"	81	11	\$ 857
APH42SD	14"	42"	36"	92	13	\$ 919
APH48SD	14"	48"	36"	99	14	\$ 983
APH54SD	14"	54"	36"	108	16	\$1,045
APH60SD	14"	60"	36"	118	18	\$1,108
APH72SD	14"	72"	36"	136	21	\$1,170

* No lock available. Optional tasklight APTSKLTX24...add \$192.
Bottom clearance 17 1/4" from fascia.

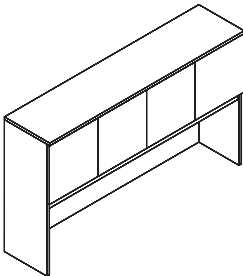

Hutch with Laminate Hinged Doors, with Fascia

Model#	Depth	Width	Height	# of Doors	Weight	Cube	Price
APH36WD	14"	36"	36"	2	83	11	\$ 766
APH42WD	14"	42"	36"	2	98	13	\$ 863
APH48WD	14"	48"	36"	4	108	14	\$ 970
APH54WD	14"	54"	36"	4	118	16	\$1,017
APH60WD	14"	60"	36"	4	129	18	\$1,061
APH66WD	14"	66"	36"	4	139	20	\$1,127
APH72WD	14"	72"	36"	4	149	21	\$1,171

Optional tasklight APTSKLTX24...add \$192.
Optional face locks (two locks are required for 42"W & 4 door hutches) MMFL...add \$78 each.
Bottom clearance 17 1/4" from fascia.

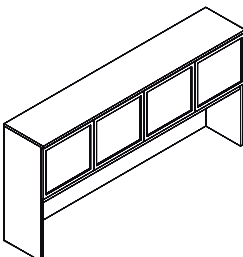

Hutch with Frosted Glass Doors, with Fascia

Model#	Depth	Width	Height	# of Doors	Weight	Cube	Price
APH36WG	14"	36"	36"	2	82	11	\$ 983
APH72WG	14"	72"	36"	4	145	21	\$1,667

* No lock available. Optional tasklight APTSKLTX24...add \$192.
Bottom clearance 17 1/4" from fascia.

apex series

Hutches

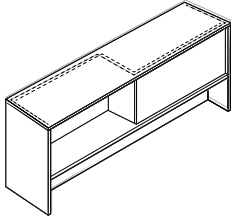

Two-Sided Hutch with Open Shared Bins

Model#	Depth	Width	Height	Weight	Cube	Price
APHSB60	14"	60"	25"	84	13	\$869
APHSB66	14"	66"	25"	91	14	\$903
APHSB72	14"	72"	25"	97	15	\$937

Bottom clearance 9"H.
Optional tackboards available for lower and upper section.

Tasklight

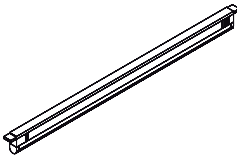

Tasklight, Black (Additional option for hutch or wall mount cabinets)

Model#	Depth	Width	Height	Weight	Cube	Price
APTKLTX24	7/8"	24 1/2"	1 7/8"	1	1	\$192

LED light. Inter connect to other lights, can link up to 6 units max.
One grommet is included on hutch back panel.

Tackboards

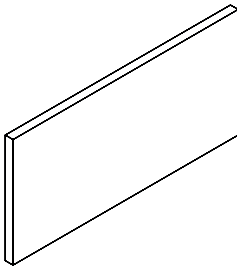

Tackboard (For hutches with 36" height)

Model#	Depth	Width	Height	Hutch Width	Weight	Cube	Price
APTKBD1936	1"	34"	19"	36"	6	1	\$318
APTKBD1942	1"	40"	19"	42"	7	1	\$397
¹⁵ APTKBD1948	1"	46"	19"	48"	8	1	\$420
APTKBD1954	1"	52"	19"	54"	9	1	\$432
¹⁵ APTKBD1960	1"	58"	19"	60"	10	1	\$488
APTKBD1966	1"	64"	19"	66"	11	1	\$522
¹⁵ APTKBD1972	1"	70"	19"	72"	12	1	\$557

For underground fabrics add 25%.

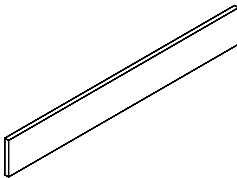

Tackboard (Lower) for Two Sided Hutch

Model#	Depth	Width	Height	Hutch Width	Weight	Cube	Price
APTKBD0860	1"	58"	8"	60"	5	1	\$323
APTKBD0866	1"	64"	8"	66"	5	1	\$346
APTKBD0872	1"	70"	8"	72"	5	1	\$374

Fits APHSB hutch only. Two lower tackboards required on two sided hutch.
For underground fabrics add 25%.

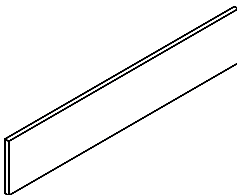

Tackboard (Upper) for Two Sided Hutch

Model#	Depth	Width	Height	Hutch Width	Weight	Cube	Price
APTKBD1530	1"	29"	15"	60"	4	1	\$302
APTKBD1533	1"	32"	15"	66"	5	1	\$318
APTKBD1536	1"	35"	15"	72"	5	1	\$341

Fits APHSB hutch only. Two upper tackboards required on two sided hutch.
For underground fabrics add 25%.

apex series

Tackboards

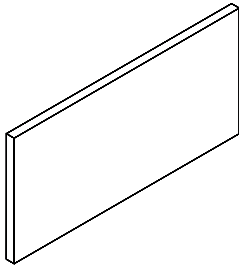

Tackboard (For 15"H TFM privacy screens)

Model#	Depth	Width	Height	Weight	Cube	Price
APTKBD1029	1"	28"	10"	3	1	\$289
APTKBD1035	1"	34"	10"	4	1	\$306
APTKBD1041	1"	40"	10"	4	1	\$383
APTKBD1047	1"	46"	10"	5	1	\$405
APTKBD1053	1"	52"	10"	5	1	\$415
15 APTKBD1059	1"	58"	10"	6	1	\$470
15 APTKBD1065	1"	64"	10"	6	1	\$502

For underground fabrics add 25%.

Cushions

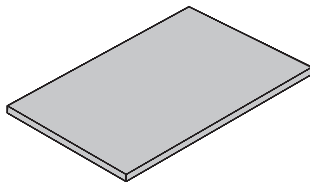

Cushion (Standard fabrics)

Model#	Depth	Width	Height	Fits Pedestal Depth	Weight	Cube	Price
15 APCUH2016	19"	16"	1"	20"	4	1	\$235
15 APCUH2416	23"	16"	1"	24"	5	1	\$250
APCUH2030	19"	30"	1"	20"	7	1	\$267
APCUH2430	23"	30"	1"	24"	8	1	\$284
15 APCUH2036	19"	36"	1"	20"	8	1	\$295
15 APCUH2436	23"	36"	1"	24"	10	1	\$314

16"w for pedestal, 30"w & 36"w for credenza. Design to fit Apex pedestal only.
For underground fabrics add 25%.

Wire Management

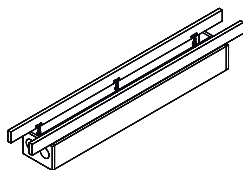

Middle Wire Management Trough with Hinged Doors

Model#	Depth	Width	Height	Weight	Cube	Price
APWMTM48	10"	36"	8"	47	3	\$563
APWMTM60	10"	48"	8"	58	3	\$671
APWMTM66	10"	54"	8"	63	4	\$749
APWMTM72	10"	60"	8"	69	4	\$841

* To be used between square panel bases. Grommet holes on left and right side.
Designed to fit shared worksurfaces only.

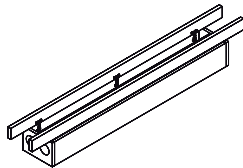

Outer Wire Management Trough with Hinged Doors

Model#	Depth	Width	Height	Weight	Cube	Price
APWMT048	10"	35"	8"	47	3	\$550
15 APWMT060	10"	47"	8"	58	3	\$658
APWMT066	10"	53"	8"	63	4	\$738
15 APWMT072	10"	59"	8"	69	4	\$829

* To be used between one metal support leg and one square panel base.
Grommet holes one side only. Designed to fit shared worksurfaces only.

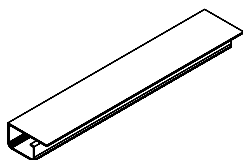

Plastic Wire Management Trough, Black

Model#	Depth	Width	Height	Weight	Cube	Price
APPWM12	2"	12"	1"	1	1	\$20
APPWM18	2"	18"	1"	1	1	\$20

Color: Black only. Field installed below worksurface with #8 x 1" wood screws (supplied).

apex series

Data/Power Management

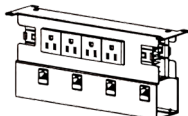
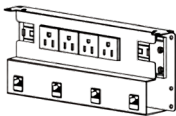
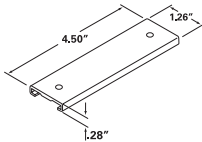
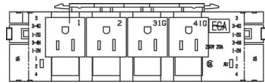
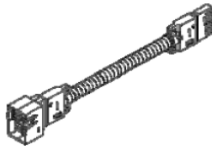
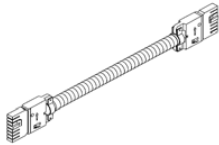
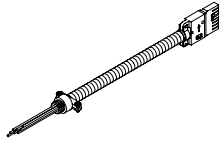

APSBS4

APSD8



Electrical Starter Cable (8-wire, 4-circuit)

Model#	Depth	Width	Height	Weight	Cube	Price
¹⁵ APESC72	1"	72"	1"	3	1	\$196

Must be connected to a building electrical supply by licensed electrician. (40) outlets maximum per single feed. (Available for freestanding trough)

Daisy Chain Electrical Cable

Model#	Depth	Width	Height	Fits Trough	Weight	Cube	Price
¹⁵ APDCE24	1"	24"	1"		2	1	\$138
¹⁵ APDCE36	1"	28"	1"		2	1	\$158
¹⁵ APDCE48	1"	40"	1"	48"	2	1	\$176
¹⁵ APDCE60	1"	52"	1"	54"	3	1	\$196
¹⁵ APDCE66	1"	58"	1"	66"	3	1	\$210
¹⁵ APDCE72	1"	64"	1"	72"	3	1	\$216

Daisy chain available for freestanding trough

Split Cable (8-wire, 4-circuit)

Model#	Depth	Width	Height	Color	Weight	Cube	Price
APSFC12	1"	12"	1"	Metal	1	1	\$129

Used to split into two directions as a "Y" coupler.

Single-Sided Power Box (4-Power outlets)

Model#	Depth	Width	Height	Weight	Cube	Price
¹⁵ APSSPB4	1 1/4"	9 5/16"	2 1/4"	1	1	\$153

Can be mounted below worksurfaces or in wire management troughs. Includes (1) circuit 1, (1) circuit 2, (1) circuit IG, (1) circuit 4. (Available for freestanding trough)

Double-Sided Power Box (8-Power outlets)

Model#	Depth	Width	Height	Weight	Cube	Price
¹⁵ APSSPB8	2"	8 7/16"	2 1/2"	1	1	\$250

Can be mounted below worksurfaces only. Includes (2) circuit 1, (2) circuit 2, (2) circuit IG, (2) circuit 4. (1) mounting bracket MB

Power Module Single and Double Sided Data Ready Units

Model#	Depth	Width	Height	Color	Weight	Cube	Price
APSBS4	1 5/8"	10 1/2"	4 1/2"	Silver	1	1	\$743
APSD8	2 1/2"	10 1/2"	4 1/2"	Silver	1	1	\$827

No cut out required. Field install under worksurface or onto a Modesty Panel. Mount hardware included. Date Hardwire Jack CAT 6. Black with Orange Bezel. APSBS4: 4 power outlets and 4 RJ45. APSBD8: 8 power outlets and 4 RJ45 (4 blank caps).

Vertibra Wire Management

Model#	Depth	Width	Height	Weight	Cube	Price
¹⁵ APVMT28	4"	4"	28"	1	1	\$181

Wire management from floor to underside of work surface (Field installed). Finish: Silver. (Available for freestanding trough)

Rectangular Power Grommet (1-Power, 2-Power USB with adapter, 108" cord)

Model#	Depth	Width	Height	Color	Weight	Cube	Price
¹⁵ APRPG1B	2 1/4"	3 3/4"	3"	Black	2	1	\$388
¹⁵ APRPG1S	2 1/4"	3 3/4"	3"	Silver	2	1	\$388
¹⁵ APRPG1GW	2 1/4"	3 3/4"	3"	Gloss White	2	1	\$388

apex freestanding troughs



NOTE: Freestanding Troughs Mix Color Option is N/A.

Trough with Center Panel

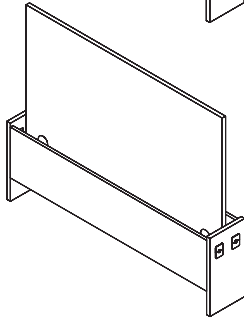
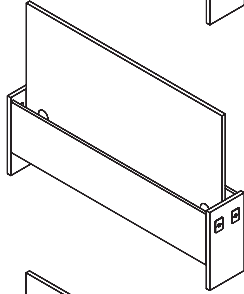
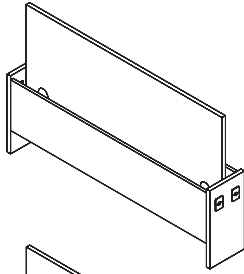

Trough No Doors with Center Panel, 36"H

Model#	Depth	Width	Height	Price
APWMT4836ND	10"	48"	20/36"	\$644
APWMT5436ND	10"	54"	20/36"	\$673
APWMT6036ND	10"	60"	20/36"	\$703
APWMT6636ND	10"	66"	20/36"	\$732
APWMT7236ND	10"	72"	20/36"	\$765

Silver Square Grommet: 2-left & right end panel, 6 grommet holes inside trough

Trough No Doors with Center Panel, 42"H

Model#	Depth	Width	Height	Price
APWMT4842ND	10"	48"	20/42"	\$667
APWMT5442ND	10"	54"	20/42"	\$700
APWMT6042ND	10"	60"	20/42"	\$732
APWMT6642ND	10"	66"	20/42"	\$765
APWMT7242ND	10"	72"	20/42"	\$799

Silver Square Grommet: 2-left & right end panel, 6 grommet holes inside trough

Trough No Doors with Center Panel, 48"H

Model#	Depth	Width	Height	Price
APWMT4848ND	10"	48"	20/48"	\$690
APWMT5448ND	10"	54"	20/48"	\$726
APWMT6048ND	10"	60"	20/48"	\$759
APWMT6648ND	10"	66"	20/48"	\$796
APWMT7248ND	10"	72"	20/48"	\$832

Silver Square Grommet: 2-left & right end panel, 6 grommet holes inside trough

Trough with Doors & Center Panel

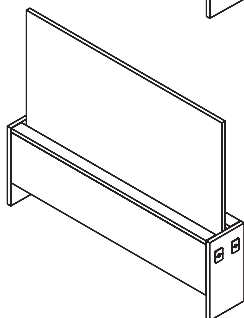
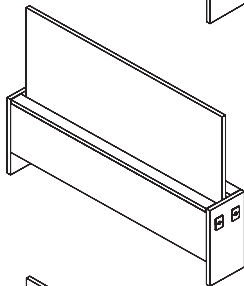
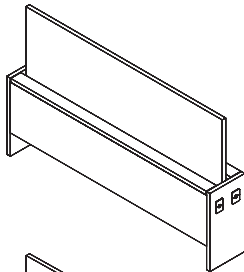

Trough with Hinged Doors and Center Panel, 36"H

Model#	Depth	Width	Height	Price
APWMT4836WD	10"	48"	20/36"	\$ 881
APWMT5436WD	10"	54"	20/36"	\$ 917
APWMT6036WD	10"	60"	20/36"	\$ 954
APWMT6636WD	10"	66"	20/36"	\$ 987
APWMT7236WD	10"	72"	20/36"	\$1,023

Silver Square Grommet: 2-left & right end panel, 6 grommet holes inside trough

Trough with Hinged Doors and Center Panel, 42"H

Model#	Depth	Width	Height	Price
APWMT4842WD	10"	48"	20/42"	\$ 904
APWMT5442WD	10"	54"	20/42"	\$ 943
APWMT6042WD	10"	60"	20/42"	\$ 980
APWMT6642WD	10"	66"	20/42"	\$1,019
APWMT7242WD	10"	72"	20/42"	\$1,056

Silver Square Grommet: 2-left & right end panel, 6 grommet holes inside trough

Trough with Hinged Doors and Center Panel, 48"H

Model#	Depth	Width	Height	Price
APWMT4848WD	10"	48"	20/48"	\$ 928
APWMT5448WD	10"	54"	20/48"	\$ 970
APWMT6048WD	10"	60"	20/48"	\$1,010
APWMT6648WD	10"	66"	20/48"	\$1,049
APWMT7248WD	10"	72"	20/48"	\$1,092

Silver Square Grommet: 2-left & right end panel, 6 grommet holes inside trough

apex series

Trough with Center Panel & End Panel

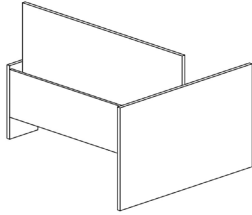

Trough No Doors with Center Panel and 48"W End Panel, 36"H

Model#	Depth	Width	Height	Price
APWMT4836ND48	10"	48"	20/36"	\$824
APWMT5436ND48	10"	54"	20/36"	\$853
APWMT6036ND48	10"	60"	20/36"	\$883
APWMT6636ND48	10"	66"	20/36"	\$912
APWMT7236ND48	10"	72"	20/36"	\$945

48"W end panel is 28"H. Silver Square Grommet: 2-on 20"H end panel, 6 grommet holes Inside Trough

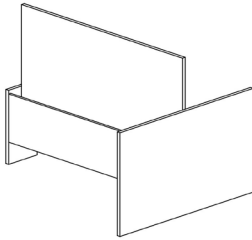

Trough No Doors with Center Panel and 48"W End Panel, 42"H

Model#	Depth	Width	Height	Price
APWMT4842ND48	10"	48"	20/42"	\$847
APWMT5442ND48	10"	54"	20/42"	\$880
APWMT6042ND48	10"	60"	20/42"	\$912
APWMT6642ND48	10"	66"	20/42"	\$945
APWMT7242ND48	10"	72"	20/42"	\$979

48"W end panel is 28"H. Silver Square Grommet: 2-on 20"H end panel, 6 grommet holes Inside Trough

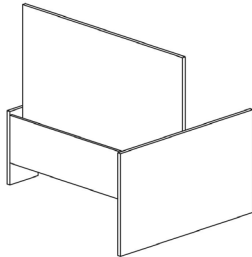

Trough No Doors with Center Panel and 48"W End Panel, 48"H

Model#	Depth	Width	Height	Price
APWMT4848ND48	10"	48"	20/48"	\$ 869
APWMT5448ND48	10"	54"	20/48"	\$ 906
APWMT6048ND48	10"	60"	20/48"	\$ 939
APWMT6648ND48	10"	66"	20/48"	\$ 976
APWMT7248ND48	10"	72"	20/48"	\$1,012

48"W end panel is 28"H. Silver Square Grommet: 2-on 20"H end panel, 6 grommet holes Inside Trough

Trough with Doors, Center Panel & End Panel

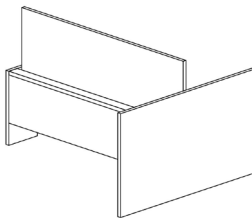

Trough with Hinged Doors Center Panel and 48"W End Panel, 36"H

Model#	Depth	Width	Height	Price
APWMT4836WD48	10"	48"	20/36"	\$1,061
APWMT5436WD48	10"	54"	20/36"	\$1,097
APWMT6036WD48	10"	60"	20/36"	\$1,134
APWMT6636WD48	10"	66"	20/36"	\$1,167
APWMT7236WD48	10"	72"	20/36"	\$1,203

48"W end panel is 28"H. Silver Square Grommet: 2-on 20"H end panel, 6 grommet holes Inside Trough

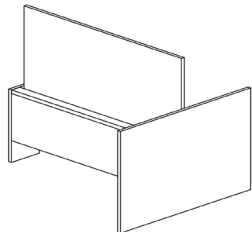

Trough with Hinged Doors Center Panel and 48"W End Panel, 42"H

Model#	Depth	Width	Height	Price
APWMT4842WD48	10"	48"	20/42"	\$1,084
APWMT5442WD48	10"	54"	20/42"	\$1,123
APWMT6042WD48	10"	60"	20/42"	\$1,160
APWMT6642WD48	10"	66"	20/42"	\$1,199
APWMT7242WD48	10"	72"	20/42"	\$1,236

48"W end panel is 28"H. Silver Square Grommet: 2-on 20"H end panel, 6 grommet holes Inside Trough

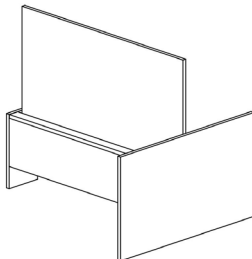

Trough with Hinged Doors Center Panel and 48"W End Panel, 48"H

Model#	Depth	Width	Height	Price
APWMT4848WD48	10"	48"	20/48"	\$1,108
APWMT5448WD48	10"	54"	20/48"	\$1,153
APWMT6048WD48	10"	60"	20/48"	\$1,190
APWMT6648WD48	10"	66"	20/48"	\$1,229
APWMT7248WD48	10"	72"	20/48"	\$1,272

48"W end panel is 28"H. Silver Square Grommet: 2-on 20"H end panel, 6 grommet holes Inside Trough

apex series

Trough with Center Panel & End Panel

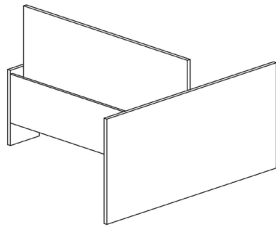

Trough No Doors with Center Panel and 60"W End Panel, 36"H

Model#	Depth	Width	Height	Price
APWMT4836ND60	10"	48"	20/36"	\$859
APWMT5436ND60	10"	54"	20/36"	\$888
APWMT6036ND60	10"	60"	20/36"	\$918
APWMT6636ND60	10"	66"	20/36"	\$947
APWMT7236ND60	10"	72"	20/36"	\$981

60"W end panel is 28"H. Silver Square Grommet: 2-on 20"H end panel, 6 grommet holes inside trough

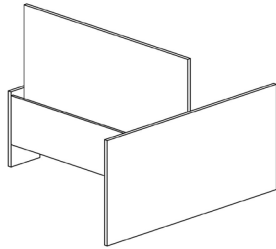

Trough No Doors with Center Panel and 60"W End Panel, 42"H

Model#	Depth	Width	Height	Price
APWMT4842ND60	10"	48"	20/42"	\$ 882
APWMT5442ND60	10"	54"	20/42"	\$ 915
APWMT6042ND60	10"	60"	20/42"	\$ 947
APWMT6642ND60	10"	66"	20/42"	\$ 981
APWMT7242ND60	10"	72"	20/42"	\$1,014

60"W end panel is 28"H. Silver Square Grommet: 2-on 20"H end panel, 6 grommet holes inside trough

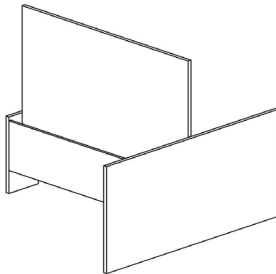

Trough No Doors with Center Panel and 60"W End Panel, 48"H

Model#	Depth	Width	Height	Price
APWMT4848ND60	10"	48"	20/48"	\$ 905
APWMT5448ND60	10"	54"	20/48"	\$ 941
APWMT6048ND60	10"	60"	20/48"	\$ 974
APWMT6648ND60	10"	66"	20/48"	\$1,011
APWMT7248ND60	10"	72"	20/48"	\$1,047

60"W end panel is 28"H. Silver Square Grommet: 2-on 20"H end panel, 6 grommet holes inside trough

Trough with Doors, Center Panel & End Panel

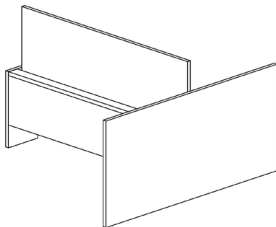

Trough with Hinged Doors Center Panel and 60"W End Panel, 36"H

Model#	Depth	Width	Height	Price
APWMT4836WD60	10"	48"	20/36"	\$1,096
APWMT5436WD60	10"	54"	20/36"	\$1,133
APWMT6036WD60	10"	60"	20/36"	\$1,169
APWMT6636WD60	10"	66"	20/36"	\$1,202
APWMT7236WD60	10"	72"	20/36"	\$1,239

60"W end panel is 28"H. Silver Square Grommet: 2-on 20"H end panel, 6 grommet holes inside trough

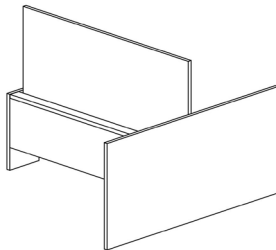

Trough with Hinged Doors Center Panel and 60"W End Panel, 42"H

Model#	Depth	Width	Height	Price
APWMT4842WD60	10"	48"	20/42"	\$1,119
APWMT5442WD60	10"	54"	20/42"	\$1,159
APWMT6042WD60	10"	60"	20/42"	\$1,195
APWMT6642WD60	10"	66"	20/42"	\$1,234
APWMT7242WD60	10"	72"	20/42"	\$1,271

60"W end panel is 28"H. Silver Square Grommet: 2-on 20"H end panel, 6 grommet holes inside trough

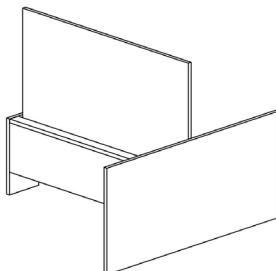

Trough with Hinged Doors Center Panel and 60"W End Panel, 48"H

Model#	Depth	Width	Height	Price
APWMT4848WD60	10"	48"	20/48"	\$1,143
APWMT5448WD60	10"	54"	20/48"	\$1,186
APWMT6048WD60	10"	60"	20/48"	\$1,225
APWMT6648WD60	10"	66"	20/48"	\$1,265
APWMT7248WD60	10"	72"	20/48"	\$1,307

60"W end panel is 28"H. Silver Square Grommet: 2-on 20"H end panel, 6 grommet holes inside trough

Trough with Center Panel & Privacy Screen (Privacy Screen Adds 12"H to Height)

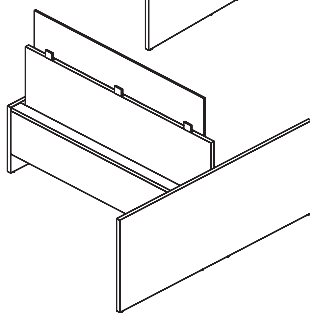
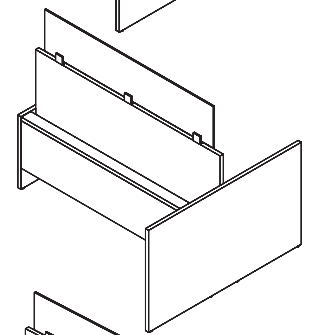
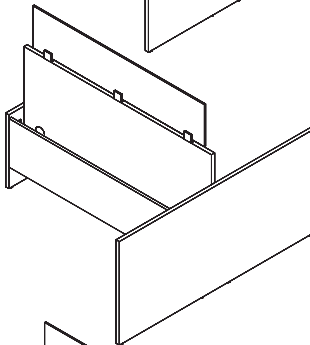
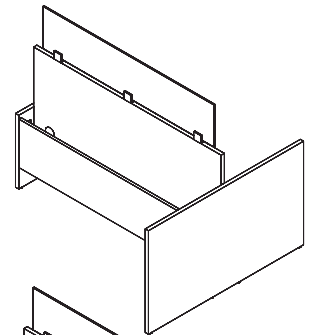
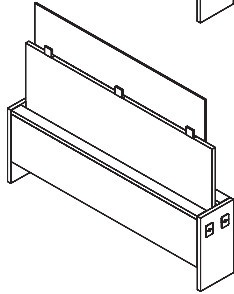
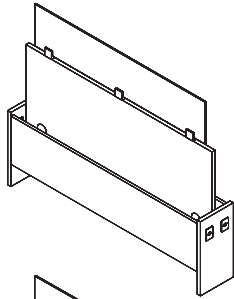

Trough No Doors with Center Panel & Frosted Acrylic Screen, 36"H

Model#	Depth	Width	Height	Privacy Screen	Price
APWMT4836NDPS	10"	48"	20/36"	APPSU48	\$1,033
APWMT5436NDPS	10"	54"	20/36"	APPSU54	\$1,230
APWMT6036NDPS	10"	60"	20/36"	APPSU60	\$1,266
APWMT6636NDPS	10"	66"	20/36"	APPSU66	\$1,300
APWMT7236NDPS	10"	72"	20/36"	APPSU72	\$1,338

Silver Square Grommet: 2-left & right end panel, 6 grommet holes inside trough

Trough with Hinged Doors, Center Panel & Frosted Acrylic Screen, 36"H

Model#	Depth	Width	Height	Privacy Screen	Price
APWMT4836WDPS	10"	48"	20/36"	APPSU48	\$1,270
APWMT5436WDPS	10"	54"	20/36"	APPSU54	\$1,475
APWMT6036WDPS	10"	60"	20/36"	APPSU60	\$1,516
APWMT6636WDPS	10"	66"	20/36"	APPSU66	\$1,555
APWMT7236WDPS	10"	72"	20/36"	APPSU72	\$1,592

Silver Square Grommet: 2-left & right end panel, 6 grommet holes inside trough

Trough with Center Panel, Privacy Screen & End Panel (Privacy Screen Adds 12"H to Height)

Trough No Doors with Center Panel, 48"W End Panel & Frosted Acrylic Screen, 36"H

Model#	Depth	Width	Height	Privacy Screen	Price
APWMT4836ND48PS	10"	48"	20/36"	APPSU48	\$1,213
APWMT5436ND48PS	10"	54"	20/36"	APPSU54	\$1,410
APWMT6036ND48PS	10"	60"	20/36"	APPSU60	\$1,446
APWMT6636ND48PS	10"	66"	20/36"	APPSU66	\$1,480
APWMT7236ND48PS	10"	72"	20/36"	APPSU72	\$1,518

48"W end panel is 28"H. Silver Square Grommet: 2-on 20"H end panel, 6 grommet holes inside trough

Trough No Doors with Center Panel, 60"W End Panel & Frosted Acrylic Screen, 36"H

Model#	Depth	Width	Height	Privacy Screen	Price
APWMT4836ND60PS	10"	48"	20/36"	APPSU48	\$1,248
APWMT5436ND60PS	10"	54"	20/36"	APPSU54	\$1,446
APWMT6036ND60PS	10"	60"	20/36"	APPSU60	\$1,481
APWMT6636ND60PS	10"	66"	20/36"	APPSU66	\$1,515
APWMT7236ND60PS	10"	72"	20/36"	APPSU72	\$1,554

60"W end panel is 28"H. Silver Square Grommet: 2-on 20"H end panel, 6 grommet holes inside trough

Trough w/Hinged Doors Center Panel, 48"W End Panel & Frosted Acrylic Screen, 36"H

Model#	Depth	Width	Height	Privacy Screen	Price
APWMT4836WD48PS	10"	48"	20/36"	APPSU48	\$1,450
APWMT5436WD48PS	10"	54"	20/36"	APPSU54	\$1,655
APWMT6036WD48PS	10"	60"	20/36"	APPSU60	\$1,696
APWMT6636WD48PS	10"	66"	20/36"	APPSU66	\$1,735
APWMT7236WD48PS	10"	72"	20/36"	APPSU72	\$1,776

48"W end panel is 28"H. Silver Square Grommet: 2-on 20"H end panel, 6 grommet holes inside trough

Trough w/Hinged Doors Center Panel, 60"W End Panel & Frosted Acrylic Screen, 36"H

Model#	Depth	Width	Height	Privacy Screen	Price
APWMT4836WD60PS	10"	48"	20/36"	APPSU48	\$1,485
APWMT5436WD60PS	10"	54"	20/36"	APPSU54	\$1,690
APWMT6036WD60PS	10"	60"	20/36"	APPSU60	\$1,732
APWMT6636WD60PS	10"	66"	20/36"	APPSU66	\$1,770
APWMT7236WD60PS	10"	72"	20/36"	APPSU72	\$1,812

60"W end panel is 28"H. Silver Square Grommet: 2-on 20"H end panel, 6 grommet holes inside trough

apex series

Worksurfaces for Freestanding Troughs (For Freestanding Troughs)

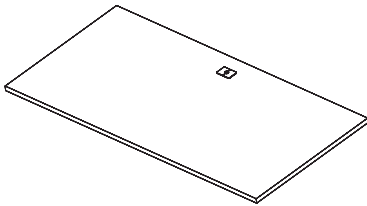

Rectangular Worksurfaces, Square Silver Grommet

Model#	Depth	Width	Height	Trough Width	Price
APRT2447	24"	47"	1"	48"	\$238
APRT2453	24"	53"	1"	54"	\$301
APRT2459	24"	59"	1"	60"	\$315
APRT2465	24"	65"	1"	66"	\$337
APRT2471	24"	71"	1"	72"	\$352
APRT3047	30"	47"	1"	48"	\$261
APRT3053	30"	53"	1"	54"	\$337
APRT3059	30"	59"	1"	60"	\$346
APRT3065	30"	65"	1"	66"	\$375
APRT3071	30"	71"	1"	72"	\$394

Center silver square grommet standard. Tops are designed to fit freestanding troughs.

Bases (For Worksurfaces)

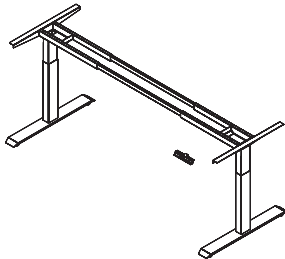

Adjustable Height Electrical Base

Model#	Base(D)	Base (W)	Height	Fits Top Size	Color	Weight	Cube	Price
MMLEGAHE24S	22"	47-72"	23 1/2-49"	24"D-72"W	Silver	64	1	\$1,366
MMLEGAHE24B	22"	47-72"	23 1/2-49"	24"D-72"W	Black	64	1	\$1,366
MMLEGAHE24W	22"	47-72"	23 1/2-49"	24"D-72"W	White	64	1	\$1,366
MMLEGAHE30S	28"	47-72"	23 1/2-49"	30"D-72"W	Silver	64	1	\$1,366
MMLEGAHE30B	28"	47-72"	23 1/2-49"	30"D-72"W	Black	64	1	\$1,366
MMLEGAHE30W	28"	47-72"	23 1/2-49"	30"D-72"W	White	64	1	\$1,366

2 Stage base.

Tackboards (For Freestanding Trough Center Panels)

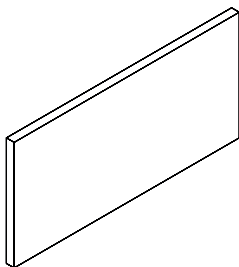

Tackboard (For 42"H & 48"H troughs)

Model#	Depth	Width	Height	Fits Trough Width	Price
APTKBD1948	1"	46"	19"	48"W	\$400
APTKBD1954	1"	52"	19"	54"W	\$411
APTKBD1960	1"	58"	19"	60"W	\$465
APTKBD1966	1"	64"	19"	66"W	\$497
APTKBD1972	1"	70"	19"	72"W	\$530

Tackboard fabric options refer to pricer P. 220.

apex series

Apex Accessories and Upgrades

HPL Modesty & Privacy Screen, Color Options



TFM Standard Colors

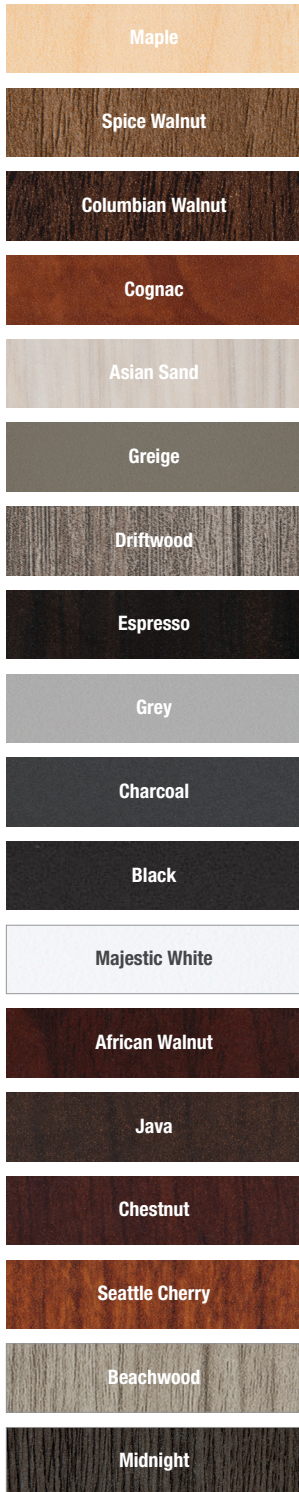

Premium TFM Colors

AVAILABLE FOR A 10% UPCHARGE, 5% upcharge for top only, 5% upcharge for drawer or door fronts (when specified with standard colors)

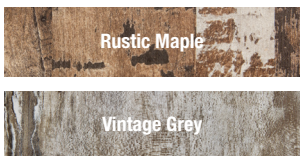

Handle



APH1
Smooth, curved edge handle in brushed aluminum

Power Management



APSSPB4/ APSSPB8
Single sided power box with four power outlets/
Double sided power box with eight power outlets



APESC72
System hardware electrical starter cable



APDCE
Daisy chain electrical cable



APFC12
Split Cable



APRPG
Rectangular Power Grommet



APVMT28
Vertebra Wire Manager

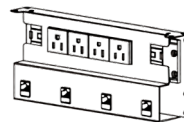

APBS4
Power Module Single Sided
Data Ready

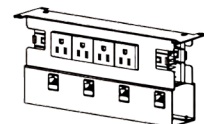

APBD8
Power Module Double Sided
Data Ready

Grommet



APRG15
Standard Rectangular Grommet - Silver

NOTE: Freestanding Troughs Mix Color Options is N/A.