

maverick series



Our signature Maverick Series combines classic all-laminate designs with the ability to mix and match any of our 20 standard colors to provide modern day durability for any office space.

Maverick | Storage Units and Reception



Maverick | Conference and Community Tables



conference collection

maverick series

 3 Days and  15 Lead Time

Product Specifications

Colors

- 20 standard colors are available on tops and chassis
- See color chart for upcharge information

Top / Worksurfaces

- 1" TFM (Thermally Fused Melamine) on industrial quality (45 lb.) particleboard
- 2 mm thermally-fused PVC edge banding
- Conference table tops have a 1 $\frac{3}{4}$ " built-up edge
- Metal-to-metal connection fittings are installed for bridges and returns
- Woodgrain direction on tops of bridges and returns runs from user side to approach side to coordinate with main unit tops

Chassis Construction

- TFM chassis fastened by screws, steel brackets, and/or concealed fasteners
- $\frac{3}{4}$ " pedestal is standard; full pedestal is optional; double-wall pedestal housing construction
- 1" -thick end panels on desks, returns, credenzas, and bookcases. $\frac{3}{4}$ " thick end panels on hutches
- $\frac{3}{4}$ " height modesty panel on $\frac{3}{4}$ " pedestal unit is standard; 12" modesty may be specified at no upcharge on bridges and returns
- Full-height modesty panel on full pedestal units such as lateral file returns is standard
- Bullet desks are standard with $\frac{3}{4}$ " modesty panel and have 4" black metal posts
- Conference tables are provided with 7" high stretcher
- Unless otherwise specified, conference and round table bases are the same color as the top. Contrasting colors may be specified at no charge
- The modesty inset on the approach side for 30"-deep tops is 6"; for 36"-deep tops, inset is 12"
- The modesty panel is flush to the approach edge on 20"-and 24"-deep tops
- Visible edges are edged with 2 mm thermally-fused PVC edge banding
- Adjustable leveling glides are provided on all units that are designed to be set on the floor
- Hutches for Maverick Series are designed to fit Maverick Series ONLY. Shipped with nail glides on legs - remove for installation
- Product heights are coordinated to facilitate matching, e.g., credenza plus hutch is 65" high. Optional 72" height is available, see page 43 for height upgrade
- Standard woodgrain direction on the modesty of pieces 60" wide or less is vertical. On pieces wider than 60", the grain direction is horizontal
- Lateral file and vertical file chassis are all $\frac{3}{4}$ " material

Drawer Interiors

- 9-ply Birch wood drawers

Drawer Suspension, Construction and Doors

- Box drawers have full-extension, progressive-action slides with precision steel ball bearings.
- Heavy-duty file rods in file drawers
- Drawer fronts are inset to end panels except on storage units
- Recessed finger pulls is standard. Handles are an accessory option, see page 53
- Storage and file units only have MMH3B handles standard
- Overlay drawer front and doors are standard on all separate storage units and separate file units. Other furniture with storage and lateral file elements are inset to the end panels of chassis and overlay at the kneespace
- All file and lateral file drawers, file letter or legal side-to-side
- Each desk only is provided with one box drawer convenience tray. See page 54 for optional additional trays for other units
- File drawer construction accommodates hanging files not stacked material on drawer bottom
- Hutch doors overlay sides before inset to top with 19" clearance below

Cord Management

- A grommet is standard on computer corner elements and reception units; $\frac{3}{4}$ " clearance at bottom of hutch backs
- Optional wire management is available - grommets on page 45

Locks

- Optional except on vertical and lateral files only; on the personal lateral file, the box drawers do not lock
- Optional locking on all pedestals, wall-mount cabinets, hinged-door storage units and hutches is available, see page 43 & 54
- Black or silver, removable cores are standard for all locks
- Pedestal key numbers are randomly assigned to all locking pedestals, except that double pedestal units will be keyed alike
- Key alike may be specified at no additional charge
- Master keys and keyed-alike combinations are available

Note: Dimensions assigned in this price list are nominal. If exact measurements are required, the requirement must be specified in the order and specifically acknowledged by Maverick. Maverick reserves the right to change construction details and standards without notification, if necessary.

maverick series

How to Order Maverick Series

WORKSURFACE UNITS: DESK, CREDENZAS AND RETURNS

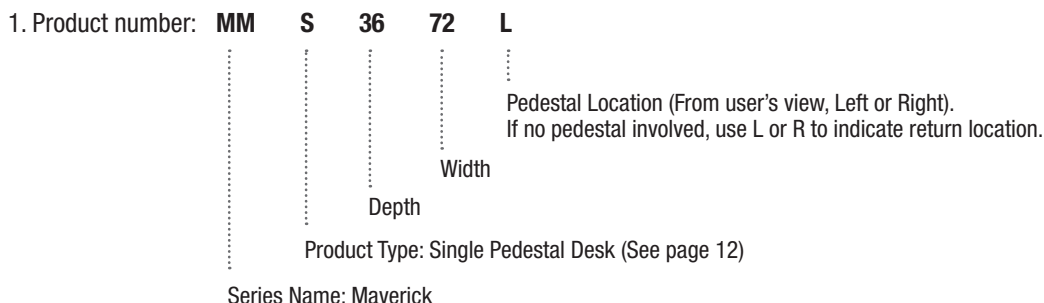

2. Specify Worksurface Finish. Matching color edge banding is standard.
3. Specify Drawer or Door Front Finish (matching color edge band is standard). For two colors...Add \$99 list.
4. Specify Chassis Finish. Matching color edge banding is standard.
5. Specify Handle Options. H3B is standard on storage and lateral file units only, upgrade to H3S no charge.
6. Specify Other Accessories or Upgrades. See pages 52-56.

HANDLE OPTIONS



Crescent Black
(MM H3B)



Crescent Silver
(MM H3S)



Elliptical Black
(MM H5B)



Elliptical Silver
(MM H5S)



Crescent Textured Nickel
(MM H6)



Flared Nickel
(MM H7)



Bow Handle
(MM H8)



Curved Handle
(MM H9)



Bar Square Handle
(MM H10)



Bar Square Handle
(MM H11)



Bar Handle
(MM H14)



Curved Edge Handle
(APH1)

IMPORTANT NOTE: H3B handle is standard only on Maverick Series storage units and lateral files (except sliding door credenzas). See page 53 for prices. H3, H5, H10 thru H14 are \$28 each, H11, H30...\$61 each. APH1...\$55 each.

maverick series

OTHER OPTIONS / UPGRADES

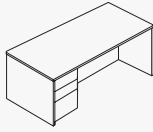

Full Pedestal
box/box/file (C)

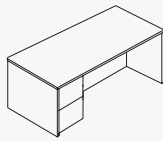

Full Pedestal
file/file (D)

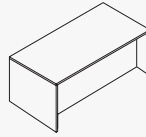

Full Modesty
(FMP)

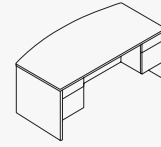

Fan Top
(F)

EDGE PROFILE

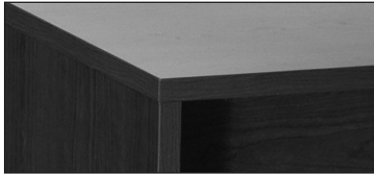

2 mm flat PVC edge banding on tops

SIDE VIEW

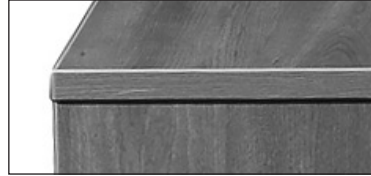

GROMMETS (WORKSURFACE)



GROMMET

Black grommet is standard where shown.
Upgrade to silver color, N/C.

NOTE: While sitting at unit, grommet locations named from left to right. For grommet location on tops and/or modesty panel specify left, center or right. No grommets over pedestals.

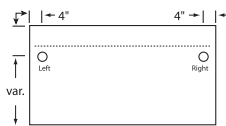

Desks

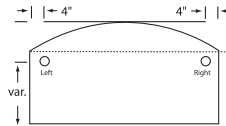

Desks

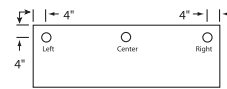

Credenza, Return,
Bridges

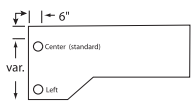

CompuCredenza

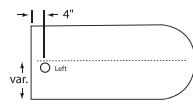

Bullets

maverick series

Statement of Line

DESK

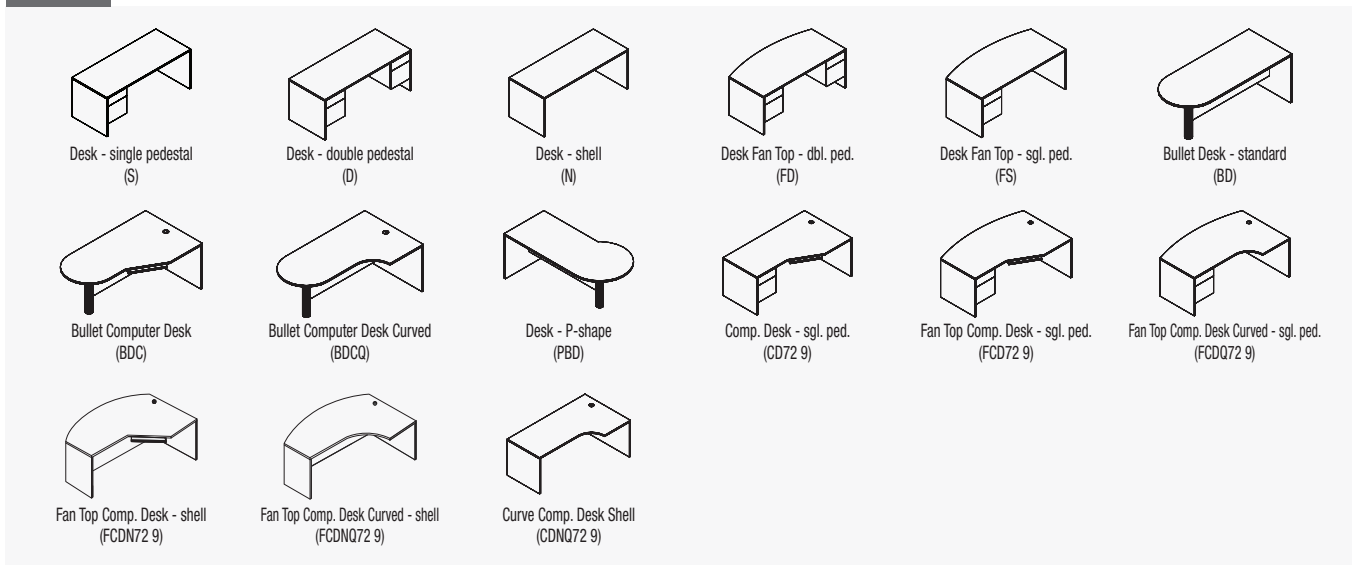

CREDENZAS

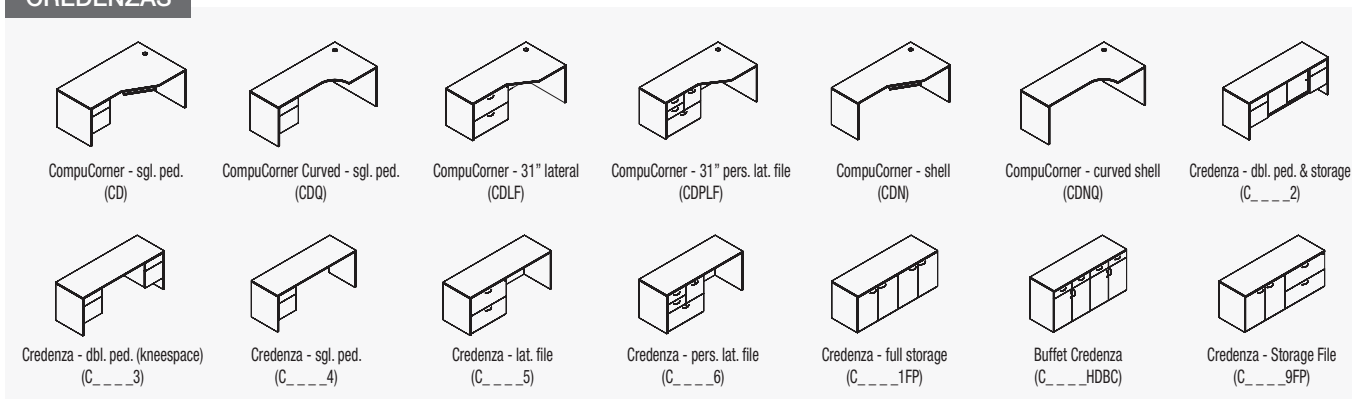

RETURNS

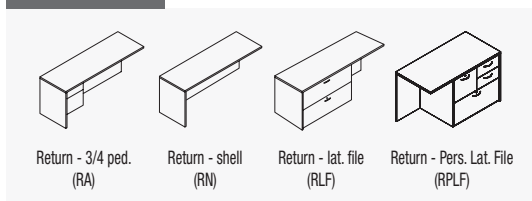

BRIDGE

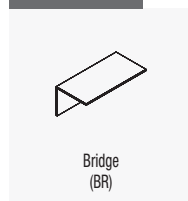

HUTCHES

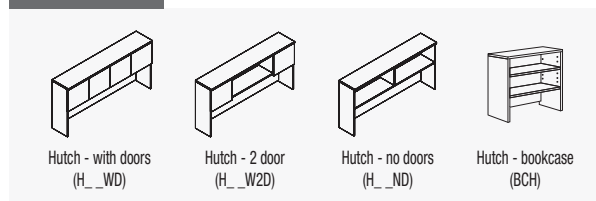

maverick series

Statement of Line

RISERS

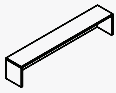

Riser (RB)

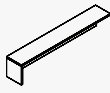

Riser return (RBR)

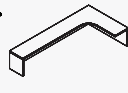

Riser L-Shape (RBL)



Riser - 36" (RB)



Riser - 48" (RB)

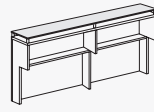

Riser - 72" (RB)

RECEPTION

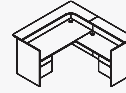

Reception - "L" (RCAL)

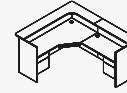

Reception - computer (RCDL)

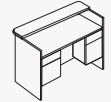

Reception - front (RCAD)

BOOKCASES

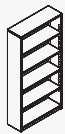

Bookcase (BC)



Bookcase - storage (BCD)



Bookcase - lateral (BCLF)

FILING

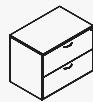

Lateral File (LF2)



Lateral File - 3-drawer (LF3)



Lateral File - 4-drawer (LF4)

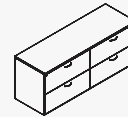

Lateral File - double (LF_2+2)

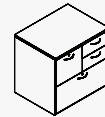

Lateral File - personal (PLF)

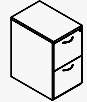

Vertical File (VF)

CONFERENCE

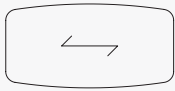

Conference Table - boatshape (BS)

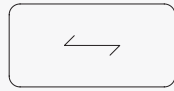

Conference Table - rectangular (RE)

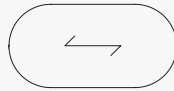

Conference Table - racetrack (RT)



Table - round (RD)

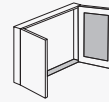

Conference board (CB)



Lectern (LEC)

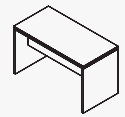

Community Table (NCT)

STORAGE



Cabinet - single (STS)

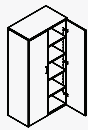

Cabinet - double (ST)

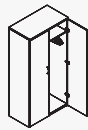

Cabinet - wardrobe (WC)



Personal Storage Unit (WCP)

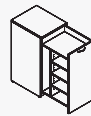

Side Door Storage Cabinet (MMSDS)

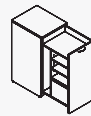

Side Door Storage Cabinet (MMSDF)



Cabinet - utility (HDC)



Cabinet - Wall Mount (CFOHD)

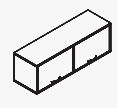

Cabinet - Wall Mount (CFOHB)

STANDS



Printer Stand (PS)

PEDESTALS



Mobile - Box/box/file (PEDCX)



Mobile - File/file (PEDDX)



Mobile - Pencil/Box/file (PEDEX)



Mobile - Box/file (PEDAX)

maverick series

Configurations - Are available for  and 

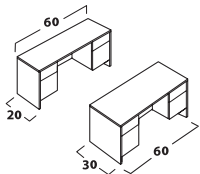

☞ MM1	
1 MMD3060	\$1,033
1 MMC2060 3	\$1,020
\$2,053	

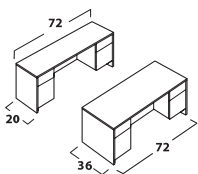

☞ MM2	
1 MMD3672	\$1,288
1 MMC2072 3	\$1,253
\$2,541	

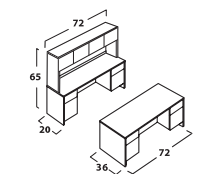

☞ MM3	
1 MMD3672	\$1,288
1 MMC2072 3	\$1,253
1 MMH72WD	\$1,229
\$3,770	

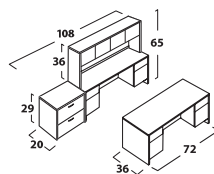

☞ MM4	
1 MMD3672	\$1,288
1 MMC2072 3	\$1,253
1 MMH72WD	\$1,229
1 MMLF202	\$936
\$4,706	

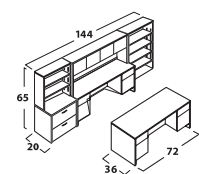

☞ MM5	
1 MMD3672	\$1,288
1 MMC2072 3	\$1,253
1 MMH72WD	\$1,229
1 MMLF202	\$936
1 MMBCB	\$450
1 MMBC3665	\$735
\$5,891	

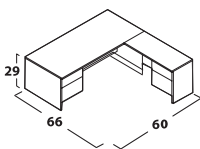

☞ MM6R	
1 MMS3060L	\$860
1 MMRA2036R	\$712
\$1,572	

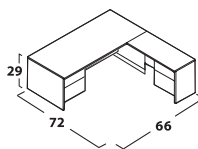

☞ MM7R	
1 MMS3066L	\$966
1 MMRA2442R	\$841
\$1,807	

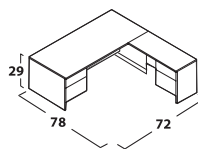

☞ MM8R	
1 MMS3672L	\$1,033
1 MMRA2442R	\$841
\$1,874	

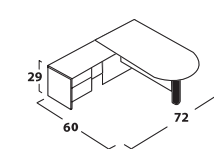

☞ MM9L	
1 MMBD3060L	\$816
1 MMRA2042L	\$725
\$1,541	

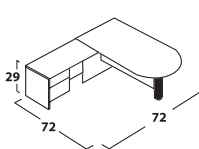

☞ MM10L	
1 MMBD3672L	\$996
1 MMRA2436L	\$812
\$1,808	

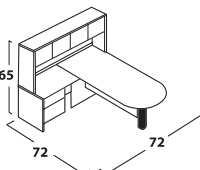

☞ MM11L	
1 MMBD3672L	\$996
1 MMRA2436L	\$812
1 MMH72WD	\$1,229
\$3,037	

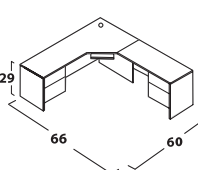

☞ MM12R	
1 MMCD60 2L	\$1,020
1 MMRA2036R	\$712
\$1,732	

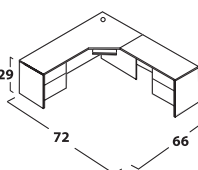

☞ MM13R	
1 MMCD66 4L	\$1,117
1 MMRA2436R	\$812
\$1,929	

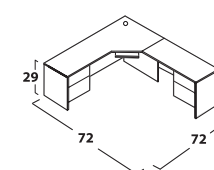

☞ MM14R	
1 MMCD72 4L	\$1,066
1 MMRA2436R	\$812
\$1,878	

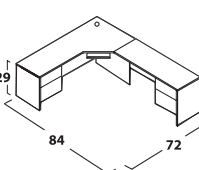

☞ MM15R	
1 MMCD72 4L	\$1,066
1 MMRA2448R	\$855
\$1,921	

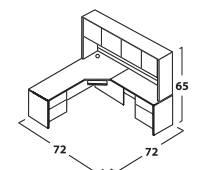

☞ MM16R	
1 MMCD72 4L	\$1,066
1 MMRA2436R	\$812
1 MMH72WD	\$1,229
\$3,107	

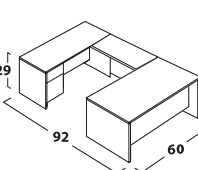

☞ MM17L	
1 MMS3060R	\$860
1 MMBR2042	\$264
1 MMC2060 4L	\$833
\$1,957	

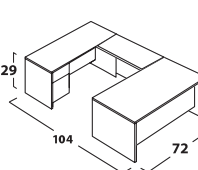

☞ MM18L	
1 MMS3672R	\$1,033
1 MMBR2448	\$400
1 MMC2072 4L	\$954
\$2,387	

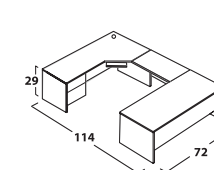

☞ MM19L	
1 MMS3672R	\$1,033
1 MMBR2442	\$356
1 MMCD72 4L	\$1,066
\$2,455	

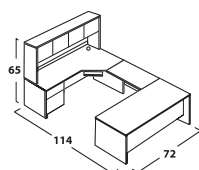

☞ MM20L	
1 MMS3672R	\$1,033
1 MMBR2442	\$356
1 MMCD72 4L	\$1,066
1 MMH72WD	\$1,229
\$3,684	

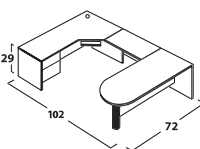

☞ MM21L	
1 MMBD3072L	\$936
1 MMBR2042	\$264
1 MMCD60 2L	\$1,020
\$2,220	

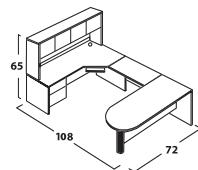

☞ MM22L	
1 MMBD3072L	\$936
1 MMBR2442	\$356
1 MMCD72 4L	\$1,066
1 MMH72WD	\$1,229
\$3,587	

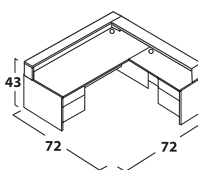

15 DAYS ☞ MM23R	
1 MMS3072L	\$983
1 MMRA2442R	\$841
1 MMRB72	\$725
1 MMRBR60R	\$574
2 MMGR234B	\$98
\$3,221	

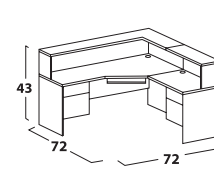

15 DAYS ☞ MM24R	
1 MMCD72 7L	\$1,169
1 MMRA2036R	\$712
1 MMRBL3672R	\$1,060
1 MMRBR36R	\$356
1 MMGR234B	\$49
\$3,346	

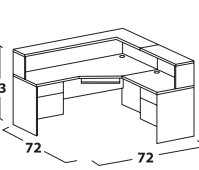

15 DAYS ☞ MM25R	
1 MMCD72 4L	\$1,066
1 MMRA2436R	\$812
1 MMRBL3672R	\$1,060
1 MMRBR36R	\$356
1 MMGR234B	\$49
\$3,343	

Use "R" or "L" to indicate the position of the return or bridge. Configurations are a small sample of total available. Configurations can be used with limited upgrade options for ☞.

maverick series

Curved Configurations - Are available for  and 

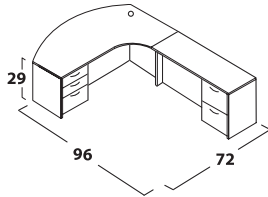

15 DAYS MQ1R	
1 MMFCDQ72C 9L	\$1,944
1 MMRD2448R SPTL	\$1,288
1 MMUHL2	\$68
1 MMUHL3	\$88
\$3,388	

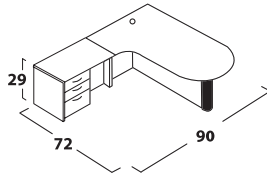

MQ2L	
1 MMBDCQ427230L FMP	\$1,130
1 MMRC2448L SPTR	\$1,288
1 MMUHL3	\$88
\$2,506	

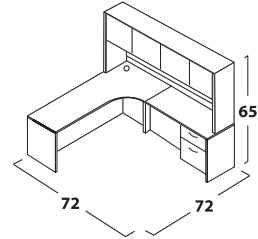

MQ3R	
1 MMCDNQ72 4R FMP	\$1,018
1 MMRA2436R SPTL, H3B	\$981
1 MMH72WD	\$1,229
\$3,228	

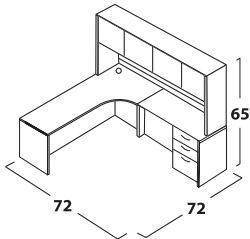

MQ4R	
1 MMCDNQ72 4R FMP	\$1,018
1 MMRC2436R SPTL, H3B	\$1,371
1 MMH72WD	\$1,229
\$3,618	

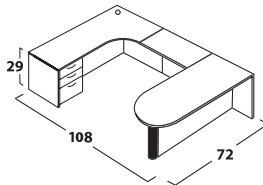

MQ5L	
1 MMBD3672 FMP	\$1,060
1 MMBR2436 FMP	\$345
1 MMCDQ72C 4L, H3B	\$1,509
\$2,914	

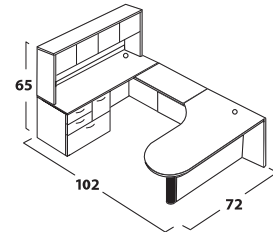

15 DAYS MQ6L	
1 MMBDCQ427230L FMP	\$1,130
1 MMBR2436 FMP	\$345
1 MMC2472 6L	\$1,813
1 MMGR234B RIGHT	\$49
1 MMH72WD	\$1,229
\$4,566	

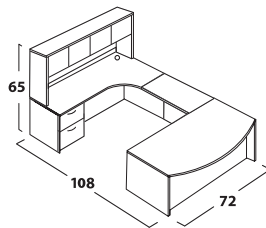

MQ7L	
1 MMFSC3672R	\$1,636
1 MMBR2436 FMP	\$345
1 MMCDQ72D 4L	\$1,383
1 MMUHL2	\$68
1 MMUHL3	\$88
1 MMH72WD	\$1,229
\$4,749	

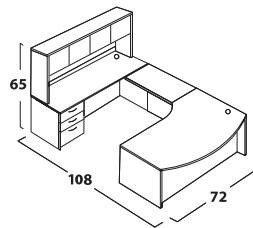



15 DAYS MQ8L	
1 MMFCDNQ72 9L FMP	\$1,293
1 MMBR2436 FMP	\$345
1 MMN2472 FMP	\$754
1 MM GR234 RIGHT	\$49
2 MMPEDCM H3B, PL (EA.)	\$911
1 MMH72WD	\$1,229
\$5,492	

Use "R" or "L" to indicate the position of the return or bridge. Configurations are a small sample of total available.

maverick series

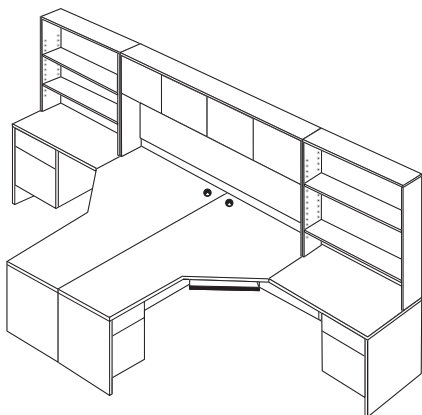
Teaming Set-up - Available for  and 



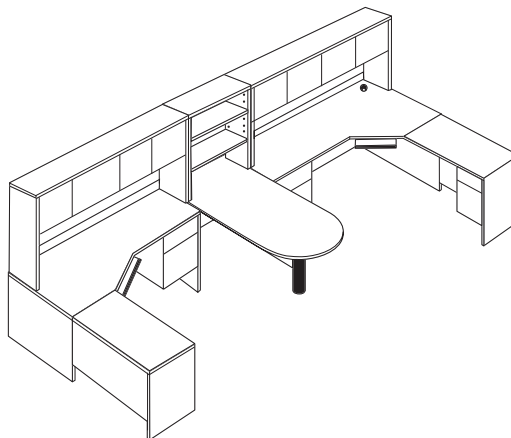

	
1 MMCD72 4R	\$1,066
1 MMCD72 4L	\$1,066
1 MMRA2436R	\$812
1 MMRA2436L	\$812
2 MMBCH	\$900
1 MMH72WD	\$1,229
\$5,885	



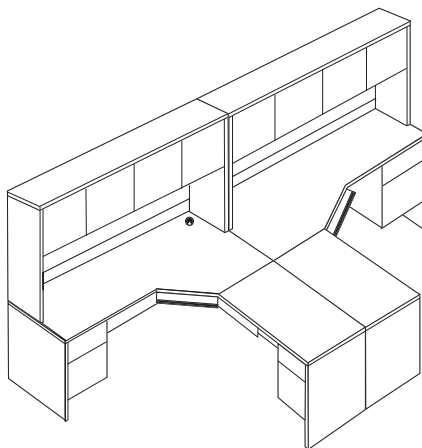

	
1 MMCD72 4R	\$1,066
1 MMCD72 4L	\$1,066
1 MMRA2436R	\$812
1 MMRA2436L	\$812
1 MMBD3672	\$996
2 MMH72WD	\$2,458
1 MMBCH	\$450
\$7,660	

NOTE: Bullet desk stand alone

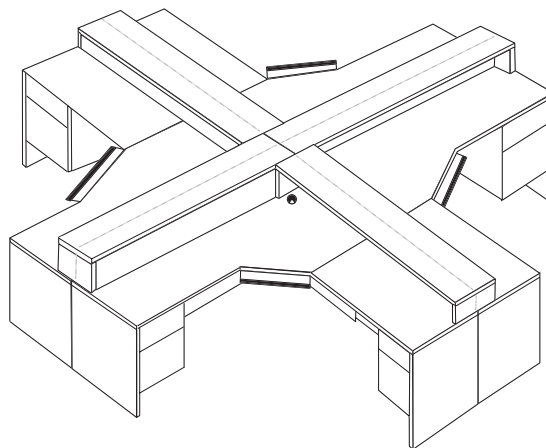

	
1 MMCD72 4R	\$1,066
1 MMCD72 4L	\$1,066
1 MMRA2436R	\$812
1 MMRA2436L	\$812
2 MMH72WD	\$2,458
\$6,214	



	
2 MMCD72 4R	\$2,132
2 MMCD72 4L	\$2,132
2 MMRA2436R	\$1,624
2 MMRA2436L	\$1,624
2 MMRB66	\$1,300
2 MMRB72	\$1,450
\$10,262	

NOTE: Risers center back panel

For pricing on other Maverick Series teaming set-ups, contact your sales representative or Customer Service.

maverick series

Desks

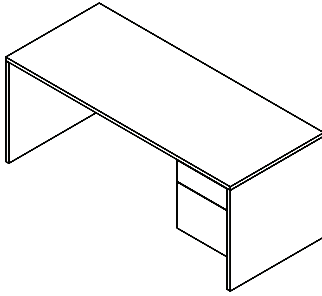

Single Pedestal Desk, Box/File Right (¾ Modesty)

Model#	Depth	Width	Height	Weight	Cube	Price
☞ MMS2042R	20"	42"	29"	120	15	\$ 786
☞ MMS2060R	20"	60"	29"	150	20	\$ 848
☞ MMS2066R	20"	66"	29"	156	23	\$ 954
☞ MMS2072R	20"	72"	29"	163	24	\$ 966
☞ MMS2442R	24"	42"	29"	127	18	\$ 816
☞ MMS2448R	24"	48"	29"	130	20	\$ 832
☞ MMS3048R	30"	48"	29"	142	25	\$ 846
☞ MMS3060R	30"	60"	29"	190	32	\$ 860
☞ MMS3066R	30"	66"	29"	197	35	\$ 966
☞ MMS3072R	30"	72"	29"	210	38	\$ 983
☞ MMS3672R	36"	72"	29"	225	45	\$1,033

For handles and pedestal lock, add MMUHL2...\$68 (Specify H3B-H14, see p. 44).
For full modesty panel upgrade, add MMFMP...\$64.

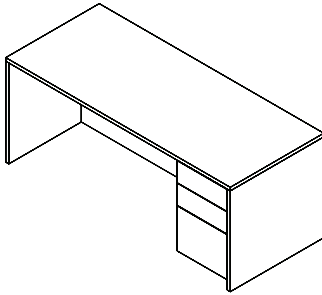

Single Pedestal Desk, Box/Box/File Right (Full modesty)

Model#	Depth	Width	Height	Weight	Cube	Price
☞ MMSC2042R	20"	42"	29"	155	15	\$1,147
☞ MMSC2060R	20"	60"	29"	180	20	\$1,205
☞ MMSC2066R	20"	66"	29"	190	23	\$1,312
☞ MMSC2072R	20"	72"	29"	200	24	\$1,328
☞ MMSC2442R	24"	42"	29"	175	18	\$1,177
☞ MMSC2448R	24"	48"	29"	183	20	\$1,194
☞ MMSC3048R	30"	48"	29"	203	25	\$1,205
☞ MMSC3060R	30"	60"	29"	224	32	\$1,222
☞ MMSC3066R	30"	66"	29"	234	35	\$1,328
☞ MMSC3072R	30"	72"	29"	244	38	\$1,342
☞ MMSC3672R	36"	72"	29"	267	45	\$1,396

For handles and pedestal lock, add MMUHL3...\$88 (Specify H3B-H14, see p. 44).

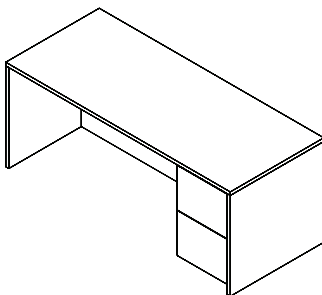

Single Pedestal Desk, File/File Right (Full modesty)

Model#	Depth	Width	Height	Weight	Cube	Price
☞ MMSD2042R	20"	42"	29"	155	15	\$1,107
☞ MMSD2060R	20"	60"	29"	180	20	\$1,165
☞ MMSD2066R	20"	66"	29"	190	23	\$1,271
☞ MMSD2072R	20"	72"	29"	200	24	\$1,284
☞ MMSD2442R	24"	42"	29"	175	18	\$1,135
☞ MMSD2448R	24"	48"	29"	183	20	\$1,152
☞ MMSD3048R	30"	48"	29"	203	25	\$1,165
☞ MMSD3060R	30"	60"	29"	224	32	\$1,181
☞ MMSD3066R	30"	66"	29"	234	35	\$1,284
☞ MMSD3072R	30"	72"	29"	244	38	\$1,302
☞ MMSD3672R	36"	72"	29"	267	45	\$1,354

For handles and pedestal lock, add MMUHL2...\$68 (Specify H3B-H14, see p. 44).

maverick series

Desks

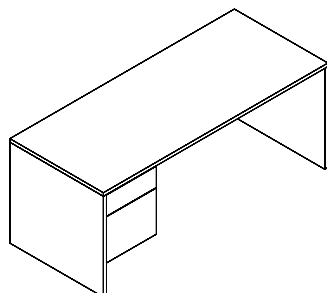

Single Pedestal Desk, Box/File Left (¾ Modesty)

Model#	Depth	Width	Height	Weight	Cube	Price
☞ MMS2042L	20"	42"	29"	120	15	\$ 786
☞ MMS2060L	20"	60"	29"	150	20	\$ 848
☞ MMS2066L	20"	66"	29"	156	23	\$ 954
☞ MMS2072L	20"	72"	29"	163	24	\$ 966
☞ MMS2442L	24"	42"	29"	127	18	\$ 816
☞ MMS2448L	24"	48"	29"	130	20	\$ 832
☞ MMS3048L	30"	48"	29"	142	25	\$ 846
☞ MMS3060L	30"	60"	29"	190	32	\$ 860
☞ MMS3066L	30"	66"	29"	197	35	\$ 966
☞ MMS3072L	30"	72"	29"	210	38	\$ 983
☞ MMS3672L	36"	72"	29"	225	45	\$1,033

For handles and pedestal lock, add MMUHL2...\$68 (Specify H3B-H14, see p. 44).
For full modesty panel upgrade, add MMFMP...\$64.

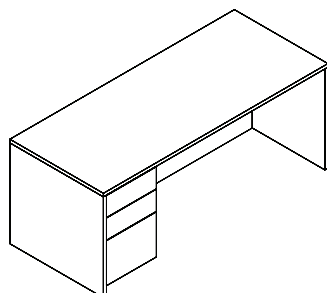

Single Pedestal Desk, Box/Box/File Left (Full modesty)

Model#	Depth	Width	Height	Weight	Cube	Price
☞ MMSC2042L	20"	42"	29"	155	15	\$1,147
☞ MMSC2060L	20"	60"	29"	180	20	\$1,205
☞ MMSC2066L	20"	66"	29"	190	23	\$1,312
☞ MMSC2072L	20"	72"	29"	200	24	\$1,328
☞ MMSC2442L	24"	42"	29"	175	18	\$1,177
☞ MMSC2448L	24"	48"	29"	183	20	\$1,194
☞ MMSC3048L	30"	48"	29"	203	25	\$1,205
☞ MMSC3060L	30"	60"	29"	224	32	\$1,222
☞ MMSC3066L	30"	66"	29"	234	35	\$1,328
☞ MMSC3072L	30"	72"	29"	244	38	\$1,342
☞ MMSC3672L	36"	72"	29"	267	45	\$1,396

For handles and pedestal lock, add MMUHL3...\$88 (Specify H3B-H14, see p. 44).

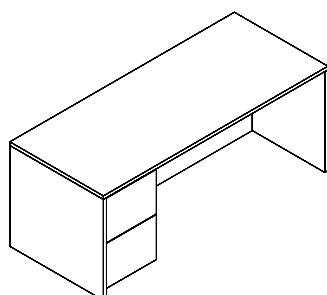

Single Pedestal Desk, File/File Left (Full modesty)

Model#	Depth	Width	Height	Weight	Cube	Price
☞ MMSD2042L	20"	42"	29"	155	15	\$1,107
☞ MMSD2060L	20"	60"	29"	180	20	\$1,165
☞ MMSD2066L	20"	66"	29"	190	23	\$1,271
☞ MMSD2072L	20"	72"	29"	200	24	\$1,284
☞ MMSD2442L	24"	42"	29"	175	18	\$1,135
☞ MMSD2448L	24"	48"	29"	183	20	\$1,152
☞ MMSD3048L	30"	48"	29"	203	25	\$1,165
☞ MMSD3060L	30"	60"	29"	224	32	\$1,181
☞ MMSD3066L	30"	66"	29"	234	35	\$1,284
☞ MMSD3072L	30"	72"	29"	244	38	\$1,302
☞ MMSD3672L	36"	72"	29"	267	45	\$1,354

For handles and pedestal lock, add MMUHL2...\$68 (Specify H3B-H14, see p. 44).

maverick series

Desks

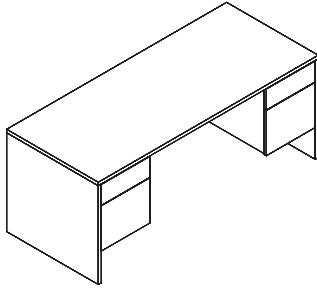

Double Pedestal Desk, Box/File Left and Right (3/4 Modesty)

Model#	Depth	Width	Height	Weight	Cube	Price
☞ MMD3060	30"	60"	29"	260	32	\$1,033
☞ MMD3066	30"	66"	29"	266	35	\$1,252
☞ MMD3072	30"	72"	29"	270	38	\$1,274
☞ MMD3672	36"	72"	29"	276	45	\$1,288

For handles and pedestal lock, add MMUHL2...\$68 each (Specify H3B-H14, see p. 44).
For full modesty panel upgrade, add MMFMP...\$64.

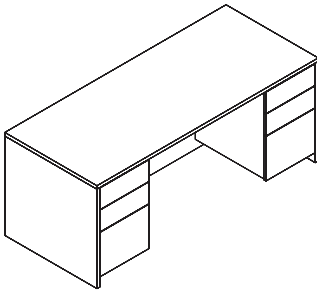

Double Pedestal Desk, Box/Box/File Left and Right (Full modesty)

Model#	Depth	Width	Height	Weight	Cube	Price
☞ MMDC3060	30"	60"	29"	294	32	\$1,396
☞ MMDC3066	30"	66"	29"	304	35	\$1,663
☞ MMDC3072	30"	72"	29"	314	38	\$1,686
☞ MMDC3672	36"	72"	29"	337	45	\$1,701

For handles and pedestal lock, add MMUHL3...\$88 each (Specify H3B-H14, see p. 44).
For left box/box/file and right file/file configuration, use model# MMDCD...N/C.

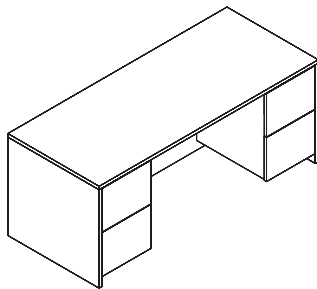

Double Pedestal Desk, File/File Left and Right (Full modesty)

Model#	Depth	Width	Height	Weight	Cube	Price
☞ MMDD3060	30"	60"	29"	294	32	\$1,354
☞ MMDD3066	30"	66"	29"	304	35	\$1,621
☞ MMDD3072	30"	72"	29"	314	38	\$1,644
☞ MMDD3672	36"	72"	29"	337	45	\$1,659

For handles and pedestal lock, add MMUHL2...\$68 each (Specify H3B-H14, see p. 44).

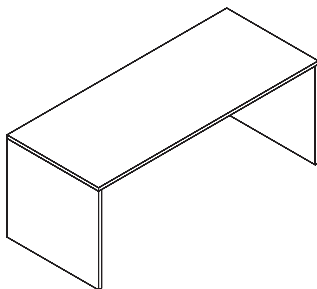

Credenza Shell 3/4 Modesty (Flush 3/4 modesty, 20" & 24"D)

Model#	Depth	Width	Height	Weight	Cube	Price
☞ MMN2042	20"	42"	29"	84	17	\$465
☞ MMN2048	20"	48"	29"	84	17	\$479
☞ MMN2060	20"	60"	29"	92	20	\$518
☞ MMN2066	20"	66"	29"	96	23	\$554
☞ MMN2072	20"	72"	29"	100	24	\$570
☞ MMN2436	24"	36"	29"	89	16	\$472
☞ MMN2442	24"	42"	29"	95	18	\$518
☞ MMN2448	24"	48"	29"	104	20	\$531
☞ MMN2460	24"	60"	29"	120	25	\$570
☞ MMN2466	24"	66"	29"	127	28	\$645
☞ MMN2472	24"	72"	29"	132	30	\$690

For left or right 1/2 leg specify on order...N/C. For full modesty panel upgrade, add MMFMP...\$64.

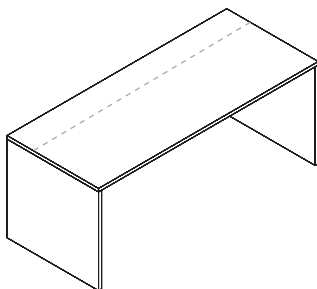

Desk Shell 3/4 Modesty (Inset modesty...30"D-6" Inset modesty, 36"D-12" Inset modesty)

Model#	Depth	Width	Height	Weight	Cube	Price
☞ MMN3042	30"	42"	29"	114	22	\$570
☞ MMN3048	30"	48"	29"	120	25	\$586
☞ MMN3060	30"	60"	29"	126	32	\$601
☞ MMN3066	30"	66"	29"	132	35	\$669
☞ MMN3072	30"	72"	29"	138	38	\$690
☞ MMN3672	36"	72"	29"	152	45	\$705

For left or right 1/2 leg specify on order...N/C. For full modesty panel upgrade, add MMFMP...\$64.

See available accessories and upgrades, pp. 53-56.

maverick series

Desks

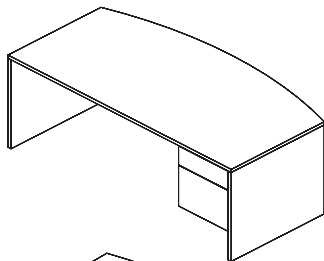

Fan Top Single Pedestal Desk, Box/File Right (¼ Modesty)

Model#	Depth	Width	Height	Weight	Cube	Price
☞ MMFS3672R	30-36"	72"	29"	233	45	\$1,274
☞ MMFS4272R	36-42"	72"	29"	258	53	\$1,318

For handles and pedestal lock, add MMUHL2...\$68 each (Specify H3B-H14, see p. 44).
For full modesty panel upgrade, add MMFMP...\$64.

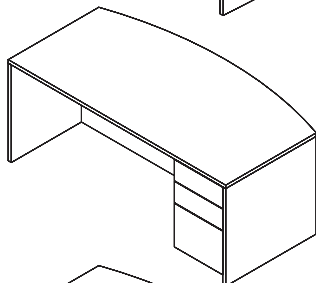

Fan Top Single Pedestal Desk, Box/Box/File Right (Full modesty)

Model#	Depth	Width	Height	Weight	Cube	Price
☞ MMFSC3672R	30-36"	72"	29"	265	45	\$1,636
☞ MMFSC4272R	36-42"	72"	29"	280	53	\$1,679

For handles and pedestal lock, add MMUHL3...\$88 (Specify H3B-H14, see p. 44).

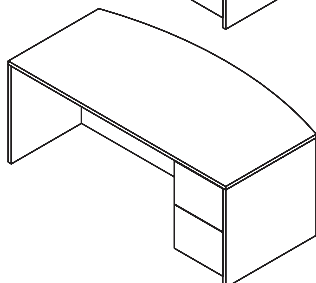

Fan Top Single Pedestal Desk, File/File Right (Full modesty)

Model#	Depth	Width	Height	Weight	Cube	Price
☞ MMFSD3672R	30-36"	72"	29"	265	45	\$1,594
☞ MMFSD4272R	36-42"	72"	29"	280	53	\$1,637

For handles and pedestal lock, add MMUHL2...\$68 (Specify H3B-H14, see p. 44).

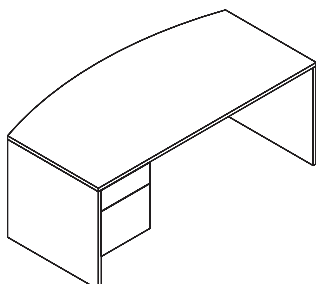

Fan Top Single Pedestal Desk, Box/File Left (¼ Modesty)

Model#	Depth	Width	Height	Weight	Cube	Price
☞ MMFS3672L	30-36"	72"	29"	233	45	\$1,274
☞ MMFS4272L	36-42"	72"	29"	258	53	\$1,318

For handles and pedestal lock, add MMUHL2...\$68 each (Specify H3B-H14, see p. 44).
For full modesty panel upgrade, add MMFMP...\$64.

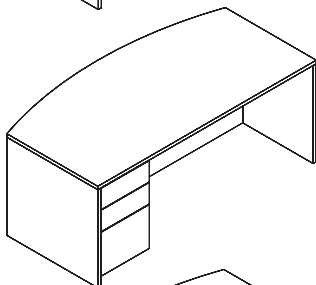

Fan Top Single Pedestal Desk, Box/Box/File Left (Full modesty)

Model#	Depth	Width	Height	Weight	Cube	Price
☞ MMFSC3672L	30-36"	72"	29"	265	45	\$1,636
☞ MMFSC4272L	36-42"	72"	29"	280	53	\$1,679

For handles and pedestal lock, add MMUHL3...\$88 (Specify H3B-H14, see p. 44).

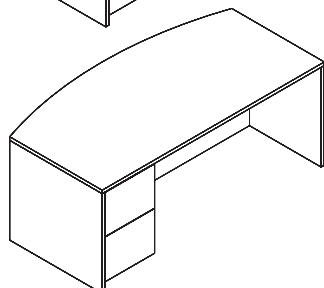

Fan Top Single Pedestal Desk, File/File Left (Full modesty)

Model#	Depth	Width	Height	Weight	Cube	Price
☞ MMFSD3672L	30-36"	72"	29"	265	45	\$1,594
☞ MMFSD4272L	36-42"	72"	29"	280	53	\$1,637

For handles and pedestal lock, add MMUHL2...\$68 (Specify H3B-H14, see p. 44).

maverick series

Desks

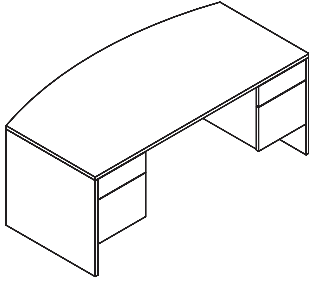

Double Pedestal Desk, Box/File Left and Right (¾ Modesty)

Model#	Depth	Width	Height	Weight	Cube	Price
☞ MMFD3672	30-36"	72"	29"	280	45	\$1,553
☞ MMFD4272	36-42"	72"	29"	305	53	\$1,567

For handles and pedestal lock, add MMUHL2...\$68 each (Specify H3B-H14, see p. 44).
For full modesty panel upgrade, add MMFMP...\$64.

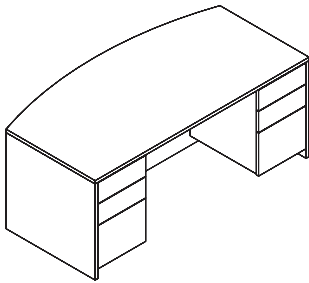

Fan Top Double Pedestal Desk, Box/Box/File Left and Right (Full modesty)

Model#	Depth	Width	Height	Weight	Cube	Price
☞ MMFDC3672	30-36"	72"	29"	335	45	\$1,913
☞ MMFDC4272	36-42"	72"	29"	350	53	\$1,927

For handles and pedestal lock, add MMUHL3...\$88 each (Specify H3B-H14, see p. 44).
For Left Box/Box/File, Right File/File configuration specify N/C. Use MMFDCD_____.

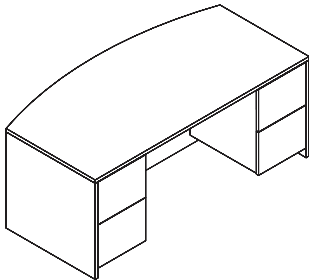

Fan Top Double Pedestal Desk, File/File Left and Right (Full modesty)

Model#	Depth	Width	Height	Weight	Cube	Price
☞ MMFDD3672	30-36"	72"	29"	335	45	\$1,871
☞ MMFDD4272	36-42"	72"	29"	350	53	\$1,883

For handles and pedestal lock, add MMUHL2...\$68 each (Specify H3B-H14, see p. 44).

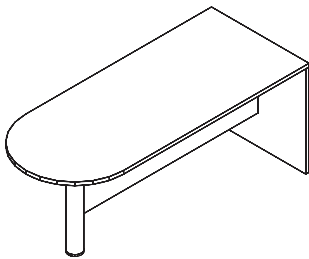

Bullet Desk, (¾ modesty, 4" black post), Left and Right Connection

Model#	Depth	Width	Height	Weight	Cube	Price
☞ MMBD3060	30"	60"	29"	180	32	\$816
☞ MMBD3072	30"	72"	29"	195	35	\$936
☞ MMBD3660	36"	60"	29"	185	38	\$936
☞ MMBD3672	36"	72"	29"	205	45	\$996

For full modesty panel upgrade, add MMFMP...\$64. For silver post upgrade, add MMUHLEGJS...\$29.
Bullet desk is set up for left and right connection.

maverick series

Desks

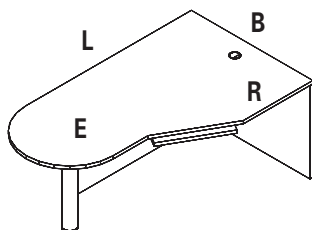

Bullet Computer Desk (¾ Modesty, 4" black post) For Right Return

Model#	Depth (B,E)	Width (L,R)	Height	Weight	Cube	Price
☞ MMBDC427230R	42/30"	72"/24"	29"	195	53	\$1,066
☞ MMBDC427830R	42/30"	78"/24"	29"	205	58	\$1,305

Keyboard tray and worksurface black grommet are standard. Upgrade grommet cover to silver, N/C. For silver post upgrade, add MMUHLEGJS...\$29. For full modesty panel upgrade, add MMFMP...\$64.

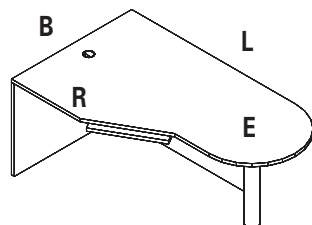

Bullet Computer Desk (¾ Modesty, 4" black post) For Left Return

Model#	Depth (B,E)	Width (L,R)	Height	Weight	Cube	Price
☞ MMBDC427230L	42/30"	72"/24"	29"	195	53	\$1,066
☞ MMBDC427830L	42/30"	78"/24"	29"	205	58	\$1,305

Keyboard tray and worksurface black grommet are standard. Upgrade grommet cover to silver, N/C. For silver post upgrade, add MMUHLEGJS...\$29. For full modesty panel upgrade, add MMFMP...\$64.

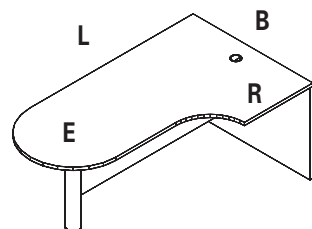

Bullet Computer Desk, Curved (¾ Modesty, 4" black post) For Right Return

Model#	Depth (B,E)	Width (L,R)	Height	Weight	Cube	Price
☞ MMBDCQ427230R	42/30"	72"/24"	29"	195	53	\$1,066

Worksurface black grommet standard. Upgrade grommet cover to silver, N/C. For silver post upgrade, add MMUHLEGJS...\$29. For full modesty panel upgrade, add MMFMP...\$64.

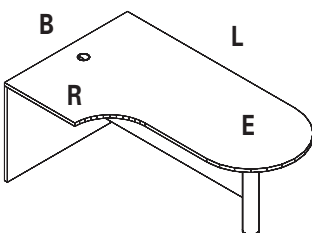

Bullet Computer Desk, Curved (¾ Modesty, 4" black post) For Left Return

Model#	Depth (B,E)	Width (L,R)	Height	Weight	Cube	Price
☞ MMBDCQ427230L	42/30"	72"/24"	29"	195	53	\$1,066

Worksurface black grommet standard. Upgrade grommet cover to silver, N/C. For silver post upgrade, add MMUHLEGJS...\$29. For full modesty panel upgrade, add MMFMP...\$64.

maverick series

Desks

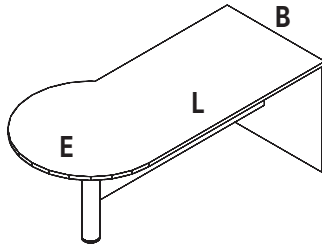

P-shape Desk (¾ Modesty, 4" black post) For Right Return

Model#	Depth (B,E)	Width (L)	Height	Weight	Cube	Price
MMPBD3072R	30/36"	72"	29"	200	45	\$1,138
MMPBD3672R	36/42"	72"	29"	205	53	\$1,199
MMPBD3678R	36/42"	78"	29"	215	49	\$1,305
MMPBD3684R	36/42"	84"	29"	225	62	\$1,507

For silver post upgrade, add MMUHLEGJS...\$29. For full modesty panel upgrade, add MMFMP...\$64.

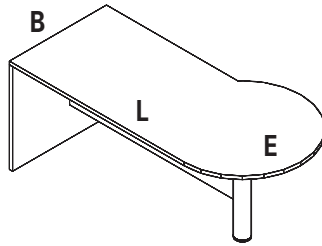

P-shape Desk (¾ Modesty, 4" black post) For Left Return

Model#	Depth (B,E)	Width (L)	Height	Weight	Cube	Price
MMPBD3072L	30/36"	72"	29"	200	45	\$1,138
MMPBD3672L	36/42"	72"	29"	205	53	\$1,199
MMPBD3678L	36/42"	78"	29"	215	49	\$1,305
MMPBD3684L	36/42"	84"	29"	225	62	\$1,507

For silver post upgrade, add MMUHLEGJS...\$29. For full modesty panel upgrade, add MMFMP...\$64.

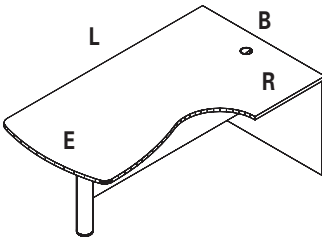

Arc End Computer Desk (¾ Modesty, 4" black post) For Right Return

Model#	Depth (B,E)	Width (L,R)	Height	Weight	Cube	Price
MMAE427236R	42/36"	72"/24"	29"	205	53	\$1,319
MMAE427836R	42/36"	78"/24"	29"	215	58	\$1,435

Black grommet standard. Upgrade grommet cover to silver, N/C. For silver post upgrade, add MMUHLEGJS...\$29. For full modesty panel upgrade, add MMFMP...\$64.

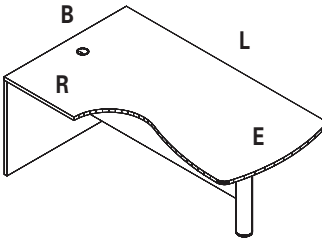

Arc End Computer Desk (¾ Modesty, 4" black post) For Left Return

Model#	Depth (B,E)	Width (L,R)	Height	Weight	Cube	Price
MMAE427236L	42/36"	72"/24"	29"	205	53	\$1,319
MMAE427836L	42/36"	78"/24"	29"	215	58	\$1,435

Black grommet standard. Upgrade grommet cover to silver, N/C. For silver post upgrade, add MMUHLEGJS...\$29. For full modesty panel upgrade, add MMFMP...\$64.

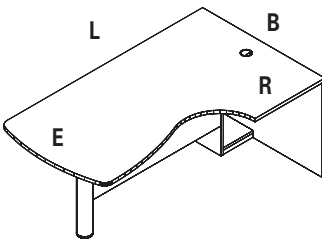

Arc End Computer Desk w/CPU Storage Cabinet (¾ Modesty, 4" black post) For Right Return

Model#	Depth (B,E)	Width (L,R)	Height	Weight	Cube	Price
MMAEC427236R	42/36"	72"/24"	29"	205	53	\$1,432
MMAEC427836R	42/36"	78"/24"	29"	215	58	\$1,639

Black grommet standard. Upgrade grommet cover to silver, N/C. For silver post upgrade, add MMUHLEGJS...\$29. For full modesty panel upgrade, add MMFMP...\$64.

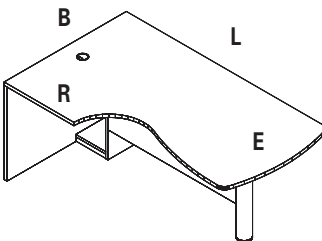

Arc End Computer Desk w/CPU Storage Cabinet (¾ Modesty, 4" black post) For Left Return

Model#	Depth (B,E)	Width (L,R)	Height	Weight	Cube	Price
MMAEC427236L	42/36"	72"/24"	29"	205	53	\$1,432
MMAEC427836L	42/36"	78"/24"	29"	215	58	\$1,639

Black grommet standard. Upgrade grommet cover to silver, N/C. For silver post upgrade, add MMUHLEGJS...\$29. For full modesty panel upgrade, add MMFMP...\$64.

maverick series

Desks

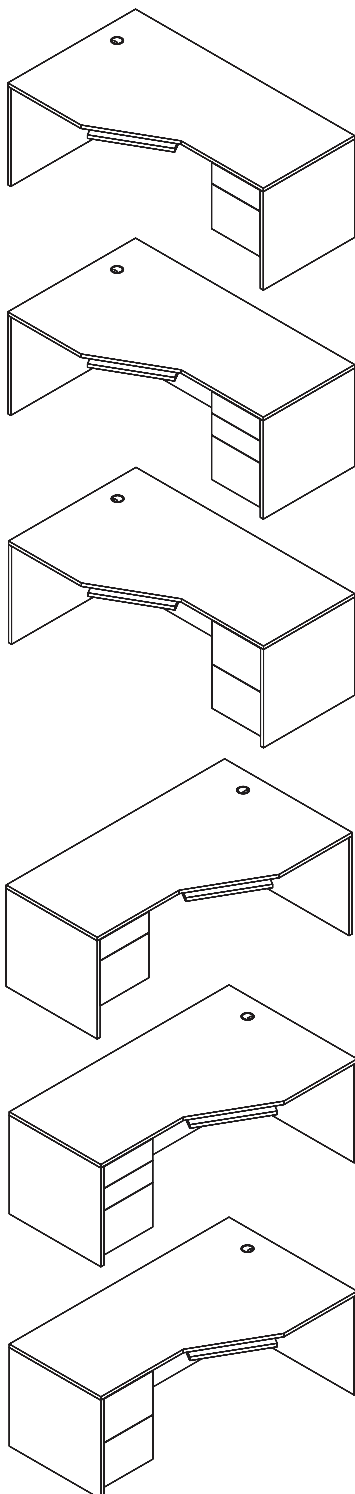

Computer Desk, Box/File Pedestal Right (Front unit, 3/4 modesty inset 6")

Model#	(L)	(B)	(E)	(K)	(R)	(W)	Weight	Cube	Price
MMCD72 9R	72"	42"	30"	24"	24"	27"	285	45	\$1,471

Keyboard tray and worksurface black grommet are standard. Upgrade grommet cover to silver, N/C. For handles and pedestal lock, add MMUHL2...\$68 each (Specify H3B-H14, see p. 44). For full modesty panel upgrade, add MMFMP...\$64.

Computer Desk, Box/Box/File Pedestal Right (Front unit, full modesty inset 6")

Model#	(L)	(B)	(E)	(K)	(R)	(W)	Weight	Cube	Price
MMCD72C 9R	72"	42"	30"	24"	24"	27"	300	45	\$1,830

Keyboard tray and worksurface black grommet are standard. Upgrade grommet cover to silver, N/C. For handles and pedestal lock, add MMUHL3...\$88 each (Specify H3B-H14, see p. 44).

Computer Desk, File/File Pedestal Right (Front unit, full modesty inset 6")

Model#	(L)	(B)	(E)	(K)	(R)	(W)	Weight	Cube	Price
MMCD72D 9R	72"	42"	30"	24"	24"	27"	300	45	\$1,789

Keyboard tray and worksurface black grommet are standard. Upgrade grommet cover to silver, N/C. For handles and pedestal lock, add MMUHL3...\$88 each (Specify H3B-H14, see p. 44).

Computer Desk, Box/File Pedestal Left (Front unit, 3/4 modesty inset 6")

Model#	(L)	(B)	(E)	(K)	(R)	(W)	Weight	Cube	Price
MMCD72 9L	72"	42"	30"	24"	24"	27"	285	45	\$1,471

Keyboard tray and worksurface black grommet are standard. Upgrade grommet cover to silver, N/C. For handles and pedestal lock, add MMUHL2...\$68 each (Specify H3B-H14, see p. 44). For full modesty panel upgrade, add MMFMP...\$64.

Computer Desk, Box/Box/File Pedestal Left (Front unit, full modesty inset 6")

Model#	(L)	(B)	(E)	(K)	(R)	(W)	Weight	Cube	Price
MMCD72C 9L	72"	42"	30"	24"	24"	27"	300	45	\$1,830

Keyboard tray and worksurface black grommet are standard. Upgrade grommet cover to silver, N/C. For handles and pedestal lock, add MMUHL3...\$88 each (Specify H3B-H14, see p. 44).

Computer Desk, File/File Pedestal Left (Front unit, full modesty inset 6")

Model#	(L)	(B)	(E)	(K)	(R)	(W)	Weight	Cube	Price
MMCD72D 9L	72"	42"	30"	24"	24"	27"	300	45	\$1,789

Keyboard tray and worksurface black grommet are standard. Upgrade grommet cover to silver, N/C. For handles and pedestal lock, add MMUHL2...\$68 each (Specify H3B-H14, see p. 44).

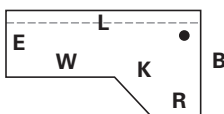

- "L" Length along approach edge
- "B" Back end panel
- "E" End panel
- "K" Keyboard space
- "R" Return size to attach
- "W" Workarea (kbd to end)

See available accessories and upgrades, pp. 53-56.

maverick series

Desks

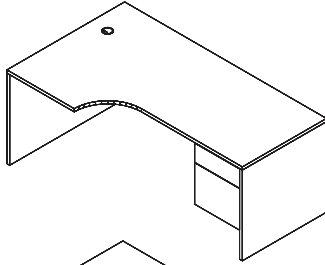

Computer Desk, Curved, Box/File Pedestal Right (Front unit, ¼ modesty inset 6")

Model#	(L)	(B)	(E)	(K)	(R)	(W)	Weight	Cube	Price
MMCDQ72 9R	72"	42"	30"	24"	24"	27"	285	45	\$1,471

No keyboard tray. Worksurface black grogmet standard. Upgrade grogmet cover to silver, N/C.
For handles and pedestal lock, add MMUHL2...\$68 (Specify H3B-H14, see p. 44).
For full modesty panel upgrade, add MMFMP...\$64.

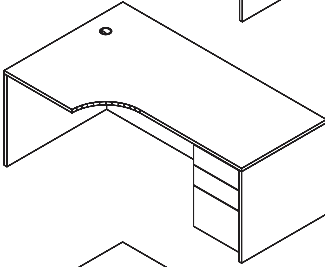

Computer Desk, Curved, Box/Box/File Pedestal Right (Front unit, Full modesty inset 6")

Model#	(L)	(B)	(E)	(K)	(R)	(W)	Weight	Cube	Price
MMCDQ72C 9R	72"	42"	30"	24"	24"	27"	300	45	\$1,830

No keyboard tray. Worksurface black grogmet standard. Upgrade grogmet cover to silver, N/C.
For handles and pedestal lock, add MMUHL3...\$88 (Specify H3B-H14, see p. 44).

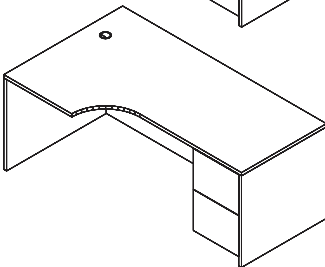

Computer Desk, Curved, File/File Pedestal Right (Front unit, full modesty inset 6")

Model#	(L)	(B)	(E)	(K)	(R)	(W)	Weight	Cube	Price
MMCDQ72D 9R	72"	42"	30"	24"	24"	27"	300	45	\$1,789

No keyboard tray. Worksurface black grogmet standard. Upgrade grogmet cover to silver, N/C.
For handles and pedestal lock, add MMUHL2...\$68 (Specify H3B-H14, see p. 44).

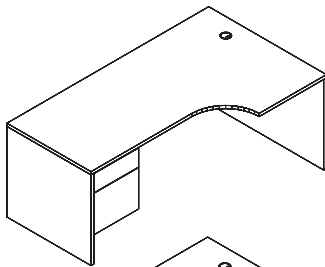

Computer Desk, Curved, Box/File Pedestal Left (Front unit, ¼ modesty inset 6")

Model#	(L)	(B)	(E)	(K)	(R)	(W)	Weight	Cube	Price
MMCDQ72 9L	72"	42"	30"	24"	24"	27"	285	45	\$1,471

No keyboard tray. Worksurface black grogmet standard. Upgrade grogmet cover to silver, N/C.
For handles and pedestal lock, add MMUHL2...\$68 (Specify H3B-H14, see p. 44).
For full modesty panel upgrade, add MMFMP...\$64.

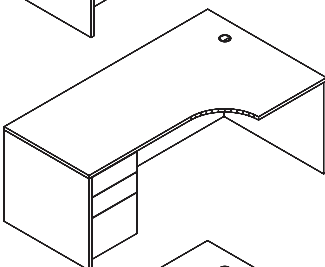

Computer Desk, Curved, Box/Box/File Pedestal Left (Front unit, full modesty inset 6")

Model#	(L)	(B)	(E)	(K)	(R)	(W)	Weight	Cube	Price
MMCDQ72C 9L	72"	42"	30"	24"	24"	27"	300	45	\$1,830

No keyboard tray. Worksurface black grogmet standard. Upgrade grogmet cover to silver, N/C.
For handles and pedestal lock, add MMUHL3...\$88 (Specify H3B-H14, see p. 44).

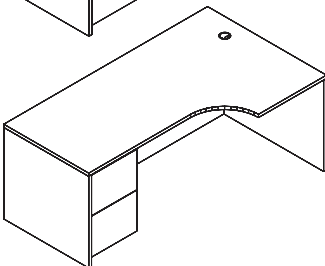

Computer Desk, Curved, File/File Pedestal Left (Front unit, full modesty inset 6")

Model#	(L)	(B)	(E)	(K)	(R)	(W)	Weight	Cube	Price
MMCDQ72D 9L	72"	42"	30"	24"	24"	27"	300	45	\$1,789

No keyboard tray. Worksurface black grogmet standard. Upgrade grogmet cover to silver, N/C.
For handles and pedestal lock, add MMUHL2...\$68 (Specify H3B-H14, see p. 44).

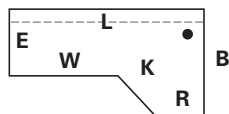

- "L" Length along approach edge
- "B" Back end panel
- "E" End panel
- "K" Keyboard space
- "R" Return size to attach
- "W" Workarea (kbrd to end)

See available accessories and upgrades, pp. 53-56.

maverick series

Desks

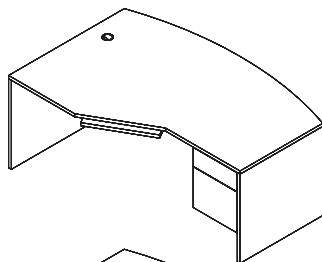

Fan Top Computer Desk, Box/File Pedestal Right (Front unit, ¼ modesty inset 6")

Model#	(L)	(B)	(E)	(K)	(R)	(W)	Weight	Cube	Price
MMFCD72 9R	72"	42"+	30"	24"	24"	27"	295	48	\$1,582

Keyboard tray and worksurface black grommet are standard. Fan front adds 6" to overall depth.
 For handles and pedestal lock, add MMUHL2...\$68 (Specify H3B-H14, see p. 44).
 For full modesty panel upgrade, add MMFMP...\$64. Upgrade grommet cover to silver, N/C.

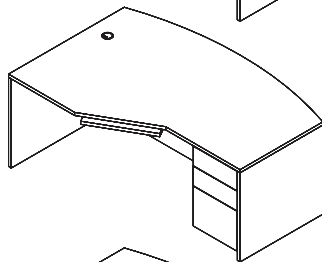

Fan Top Computer Desk, Box/Box/File Pedestal Right (Front Unit, full modesty inset 6")

Model#	(L)	(B)	(E)	(K)	(R)	(W)	Weight	Cube	Price
MMFCD72C 9R	72"	42"+	30"	24"	24"	27"	310	48	\$1,944

Keyboard tray and worksurface black grommet are standard. Fan front adds 6" to overall depth.
 For handles and pedestal lock, add MMUHL3...\$88 (Specify H3B-H14, see p. 44).
 Upgrade grommet cover to silver, N/C..

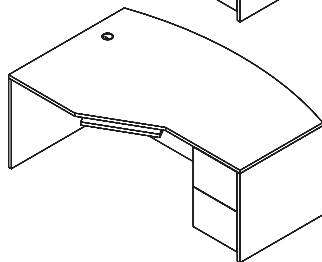

Fan Top Computer Desk, File/File Pedestal Right (Front Unit, full modesty inset 6")

Model#	(L)	(B)	(E)	(K)	(R)	(W)	Weight	Cube	Price
MMFCD72D 9R	72"	42"+	30"	24"	24"	27"	310	48	\$1,901

Keyboard tray and worksurface black grommet are standard. Fan front adds 6" to overall depth.
 For handles and pedestal lock, add MMUHL2...\$68 (Specify H3B-H14, see p. 44).
 Upgrade grommet cover to silver, N/C.

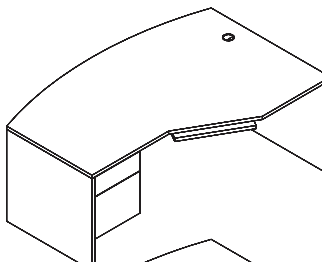

Fan Top Computer Desk, Box/File Pedestal Left (Front unit, ¼ modesty inset 6")

Model#	(L)	(B)	(E)	(K)	(R)	(W)	Weight	Cube	Price
MMFCD72 9L	72"	42"+	30"	24"	24"	27"	295	48	\$1,582

Keyboard tray and worksurface black grommet are standard. Upgrade grommet cover to silver, N/C.
 Fan front adds 6" to overall depth. For handles and pedestal lock, add MMUHL2...\$68 (Specify H3B-H14, see p. 44).
 For full modesty panel upgrade, add MMFMP...\$64.

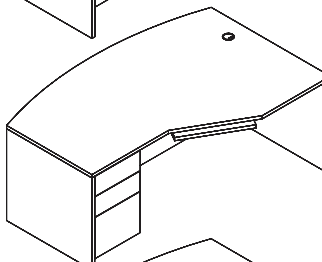

Fan Top Computer Desk, Box/Box/File Pedestal Left (Front unit, full modesty inset 6")

Model#	(L)	(B)	(E)	(K)	(R)	(W)	Weight	Cube	Price
MMFCD72C 9L	72"	42"+	30"	24"	24"	27"	310	48	\$1,944

Keyboard tray and worksurface black grommet are standard. Upgrade grommet cover to silver, N/C.
 Fan front adds 6" to overall depth. For handles and pedestal lock, add MMUHL3...\$88 (Specify H3B-H14, see p. 44).

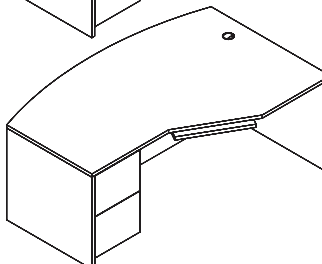

Fan Top Computer Desk, File/File Pedestal Left (Front unit, full modesty inset 6")

Model#	(L)	(B)	(E)	(K)	(R)	(W)	Weight	Cube	Price
MMFCD72D 9L	72"	42"+	30"	24"	24"	27"	310	48	\$1,901

Keyboard tray and worksurface black grommet are standard. Upgrade grommet cover to silver, N/C.
 Fan front adds 6" to overall depth. For handles and pedestal lock, add MMUHL2...\$68 (Specify H3B-H14, see p. 44).

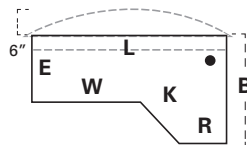

- "L" Length along approach edge
- "B" Back end panel (Fan top adds 6")
- "E" End panel
- "K" Keyboard space
- "R" Return size to attach
- "W" Workarea (kbrd to end)

See available accessories and upgrades, pp. 53-56.

maverick series

Desks

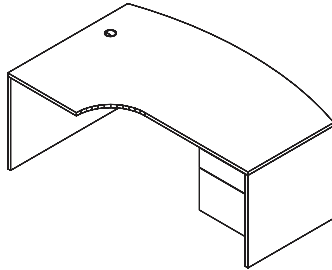

Fan Top Computer Desk, Curved, Box/File Pedestal Right (Front unit, ¼ modesty inset 6")

Model#	(L)	(B)	(E)	(K)	(R)	(W)	Weight	Cube	Price
MMFCDQ72 9R	72"	42"+	30"	24"	24"	27"	295	48	\$1,582

No Keyboard tray, worksurface black grommet standard. Fan front adds 6" to overall depth.
 Upgrade grommet cover to silver, N/C.
 For handles and pedestal lock, add MMUHL2...\$68 (Specify H3B-H14, see p. 44).
 For full modesty panel upgrade, add MMFMP...\$64.

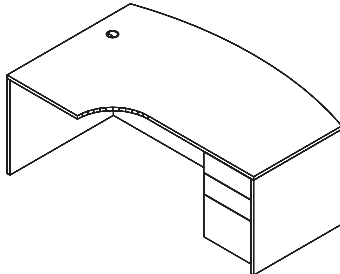

Fan Top Computer Desk, Curved, Box/Box/File Pedestal Right (Front unit, full modesty inset 6")

Model#	(L)	(B)	(E)	(K)	(R)	(W)	Weight	Cube	Price
MMFCDQ72C 9R	72"	42"+	30"	24"	24"	27"	310	48	\$1,944

No Keyboard tray, worksurface black grommet standard. Fan front adds 6" to overall depth.
 Upgrade grommet cover to silver, N/C.
 For handles and pedestal lock, add MMUHL3...\$88 (Specify H3B-H14, see p. 44).

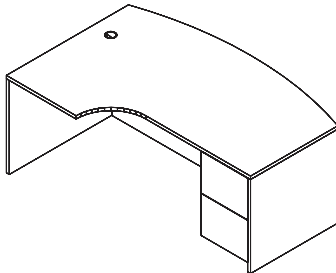

Fan Top Computer Desk, Curved, File/File Pedestal Right (Front unit, full modesty inset 6")

Model#	(L)	(B)	(E)	(K)	(R)	(W)	Weight	Cube	Price
MMFCDQ72D 9R	72"	42"+	30"	24"	24"	27"	310	48	\$1,901

No Keyboard tray, worksurface black grommet standard. Fan front adds 6" to overall depth.
 Upgrade grommet cover to silver, N/C.
 For handles and pedestal lock, add MMUHL2...\$68 (Specify H3B-H14, see p. 44).

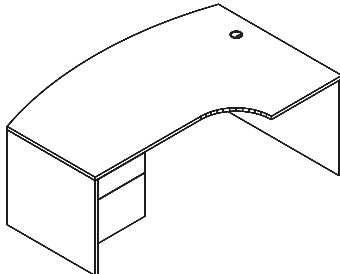

Fan Top Computer Desk, Curved, Box/File Pedestal Left (Front Unit, ¼ modesty inset 6")

Model#	(L)	(B)	(E)	(K)	(R)	(W)	Weight	Cube	Price
MMFCDQ72 9L	72"	42"+	30"	24"	24"	27"	295	48	\$1,582

No Keyboard tray, worksurface black grommet standard. Fan front adds 6" to overall depth.
 Upgrade grommet cover to silver, N/C.
 For handles and pedestal lock, add MMUHL2...\$68 (Specify H3B-H14, see p. 44).
 For full modesty panel upgrade, add MMFMP...\$64.

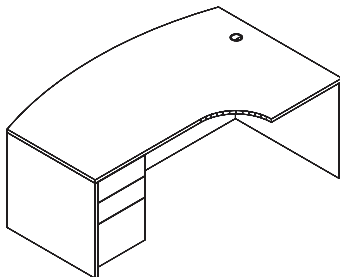

Fan Top Computer Desk, Curved, Box/Box/File Pedestal Left (Front unit, full modesty inset 6")

Model#	(L)	(B)	(E)	(K)	(R)	(W)	Weight	Cube	Price
MMFCDQ72C 9L	72"	42"+	30"	24"	24"	27"	310	48	\$1,944

No Keyboard tray, worksurface black grommet standard. Fan front adds 6" to overall depth.
 Upgrade grommet cover to silver, N/C.
 For handles and pedestal lock, add MMUHL3...\$88 (Specify H3B-H14, see p. 44).

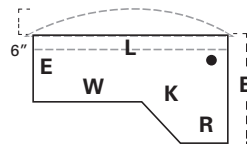

- "L" Length along approach edge
- "B" Back end panel (Fan top adds 6")
- "E" End panel
- "K" Keyboard space
- "R" Return size to attach
- "W" Workarea (kbrd to end)

See available accessories and upgrades, pp. 53-56.

maverick series

Desks

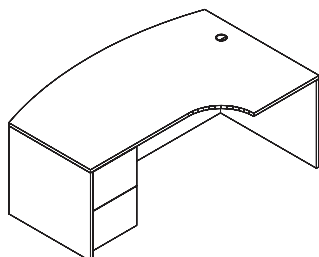

Fan Top Computer Desk, Curved, File/File Pedestal Left (Front unit, full modesty inset 6")

Model#	(L)	(B)	(E)	(K)	(R)	(W)	Weight	Cube	Price
MMFCDQ72D 9L	72"	42"+	30"	24"	24"	27"	310	48	\$1,901

No Keyboard tray, worksurface black grommet standard. Fan front adds 6" to overall depth.
 Upgrade grommet cover to silver, N/C.
 For handles and pedestal lock, add MMUHL2...\$68 (Specify H3B-H14, see p. 44).

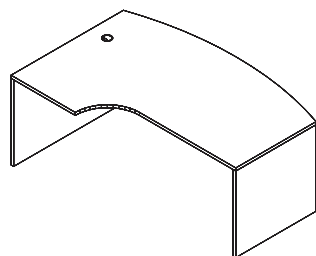

Fan Top Computer Desk Shell, Curved (Front unit, 3/4 modesty inset 6") For Left Return

Model#	(L)	(B)	(E)	(K)	(R)	(W)	Weight	Cube	Price
MMFCDNQ72 9L	72"	42"+	30"	24"	24"	27"	215	48	\$1,229

No keyboard tray. Worksurface black grommet standard. Upgrade grommet cover to silver, N/C.
 Fan front adds 6" to overall depth. For full modesty panel upgrade, add MMFMP...\$64.

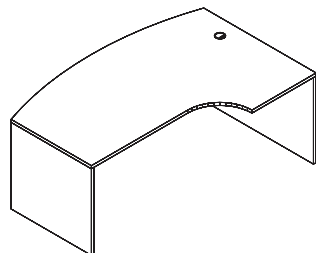

Fan Top Computer Desk Shell, Curved (Front unit, 3/4 modesty inset 6") For Right Return

Model#	(L)	(B)	(E)	(K)	(R)	(W)	Weight	Cube	Price
MMFCDNQ72 9R	72"	42"+	30"	24"	24"	27"	215	48	\$1,229

No keyboard tray. Worksurface black grommet standard. Upgrade grommet cover to silver, N/C.
 Fan front adds 6" to overall depth. For full modesty panel upgrade, add MMFMP...\$64.

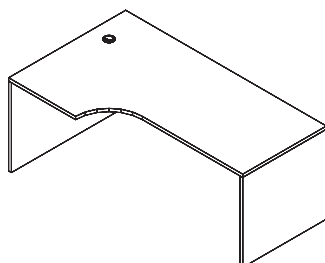

Computer Desk Shell, Curved (Front unit, 3/4 modesty inset 6") For Left Return

Model#	(L)	(B)	(E)	(K)	(R)	(W)	Weight	Cube	Price
MMCDNQ72 9L	72"	42"	30"	24"	24"	27"	166	51	\$1,229

No keyboard tray. Worksurface black grommet standard. Upgrade grommet cover to silver, N/C.
 For full modesty panel upgrade, add MMFMP...\$64.

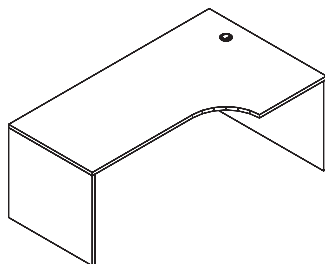

Computer Desk Shell, Curved (Front unit, 3/4 modesty inset 6") For Right Return

Model#	(L)	(B)	(E)	(K)	(R)	(W)	Weight	Cube	Price
MMCDNQ72 9R	72"	42"	30"	24"	24"	27"	166	51	\$1,229

No keyboard tray. Worksurface black grommet standard. Upgrade grommet cover to silver, N/C.
 For full modesty panel upgrade, add MMFMP...\$64.

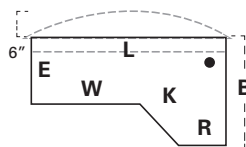

- "L" Length along approach edge
- "B" Back end panel (Fan top adds 6")
- "E" End panel
- "K" Keyboard space
- "R" Return depth to attach
- "W" Workarea (kbrd to end)

maverick series

Bridges, Returns

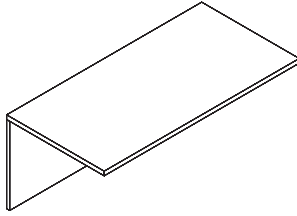

Bridge Section (¾ Modesty)

Model#	Depth	Width	Height	Weight	Cube	Price
☞ MMBR2036	20"	36"	29"	41	9	\$248
☞ MMBR2042	20"	42"	29"	48	10	\$264
☞ MMBR2048	20"	48"	29"	55	12	\$311
☞ MMBR2436	24"	36"	29"	47	10	\$281
☞ MMBR2442	24"	42"	29"	55	12	\$356
☞ MMBR2448	24"	48"	29"	63	14	\$400
☞ MMBR2460	24"	60"	29"	78	15	\$485

¾ modesty standard. ½ modesty on bridges may be specified at no upcharge.
For full modesty panel upgrade, add MMFMP...\$64.
60"W bridge requires ½ leg center support, add MMSPT \$113 list.

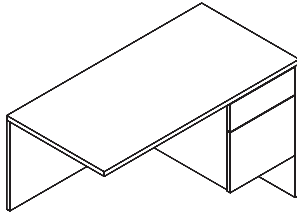

Return, ¾ Box/File Pedestal Right (¾ Modesty)

Model#	Depth	Width	Height	Weight	Cube	Price
☞ MMRA2036R	20"	36"	29"	95	13	\$712
☞ MMRA2042R	20"	42"	29"	104	15	\$725
☞ MMRA2048R	20"	48"	29"	110	17	\$742
☞ MMRA2054R	20"	54"	29"	117	19	\$771
☞ MMRA2436R	24"	36"	29"	100	15	\$812
☞ MMRA2442R	24"	42"	29"	107	18	\$841
☞ MMRA2448R	24"	48"	29"	114	20	\$855
☞ MMRA2454R	24"	54"	29"	121	23	\$916
☞ MMRA2460R	24"	60"	29"	124	24	\$931
☞ MMRA3048R	30"	48"	29"	127	25	\$931

¾ modesty standard. ½ modesty on returns may be specified at no upcharge.
For handles and pedestal lock, add MMUHL2...\$68 (Specify H3B-H14, see p. 44).
For full modesty panel upgrade, add MMFMP...\$64.

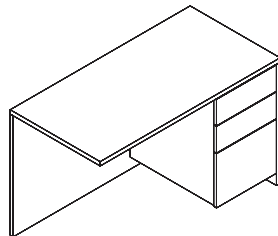

Return, Box/Box/File Pedestal Right (Full modesty)

Model#	Depth	Width	Height	Weight	Cube	Price
☞ MMRC2036R	20"	36"	29"	130	13	\$1,075
☞ MMRC2042R	20"	42"	29"	140	15	\$1,090
☞ MMRC2048R	20"	48"	29"	150	17	\$1,107
☞ MMRC2054R	20"	54"	29"	160	19	\$1,137
☞ MMRC2436R	24"	36"	29"	140	15	\$1,174
☞ MMRC2442R	24"	42"	29"	150	18	\$1,204
☞ MMRC2448R	24"	48"	29"	160	20	\$1,218
☞ MMRC2454R	24"	54"	29"	170	23	\$1,281
☞ MMRC2460R	24"	60"	29"	180	24	\$1,294
☞ MMRC3048R	30"	48"	29"	175	25	\$1,294

Full modesty standard. ½ modesty on returns may be specified at no upcharge.
For handles and pedestal lock, add MMUHL3...\$88 (Specify H3B-H14, see p. 44).

maverick series

Returns

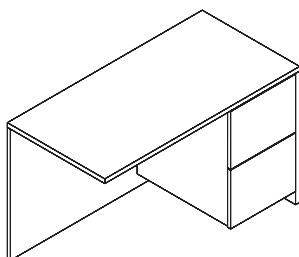

Return, File/File Pedestal Right (Full modesty)

Model#	Depth	Width	Height	Weight	Cube	Price
☞ MMRD2036R	20"	36"	29"	130	13	\$1,032
☞ MMRD2042R	20"	42"	29"	140	15	\$1,047
☞ MMRD2048R	20"	48"	29"	150	17	\$1,063
☞ MMRD2054R	20"	54"	29"	160	19	\$1,094
☞ MMRD2436R	24"	36"	29"	140	15	\$1,134
☞ MMRD2442R	24"	42"	29"	150	18	\$1,144
☞ MMRD2448R	24"	48"	29"	160	20	\$1,175
☞ MMRD2454R	24"	54"	29"	170	23	\$1,239
☞ MMRD2460R	24"	60"	29"	180	24	\$1,250
☞ MMRD3048R	30"	48"	29"	175	25	\$1,250

Full modesty standard. ½ modesty on returns may be specified at no upcharge.
For handles and pedestal lock, add MMUHL2...\$68 (Specify H3B-H14, see p. 44).

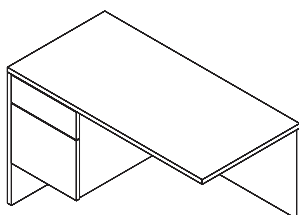

Return, ¾ Box/File Pedestal Left (¾ Modesty)

Model#	Depth	Width	Height	Weight	Cube	Price
☞ MMRA2036L	20"	36"	29"	95	13	\$712
☞ MMRA2042L	20"	42"	29"	104	15	\$725
☞ MMRA2048L	20"	48"	29"	110	17	\$742
☞ MMRA2054L	20"	54"	29"	117	19	\$771
☞ MMRA2436L	24"	36"	29"	100	15	\$812
☞ MMRA2442L	24"	42"	29"	107	18	\$841
☞ MMRA2448L	24"	48"	29"	114	20	\$855
☞ MMRA2454L	24"	54"	29"	121	23	\$916
☞ MMRA2460L	24"	60"	29"	124	24	\$931
☞ MMRA3048L	30"	48"	29"	127	25	\$931

¾ modesty standard. ½ modesty on returns may be specified at no upcharge.
For handles and pedestal lock, add MMUHL2...\$68 (Specify H3B-H14, see p. 44).
For full modesty panel upgrade, add MMFMP...\$64.

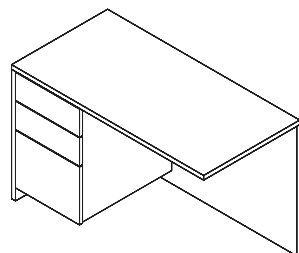

Return, Box/Box/File Pedestal Left (Full modesty)

Model#	Depth	Width	Height	Weight	Cube	Price
☞ MMRC2036L	20"	36"	29"	130	13	\$1,075
☞ MMRC2042L	20"	42"	29"	140	15	\$1,090
☞ MMRC2048L	20"	48"	29"	150	17	\$1,107
☞ MMRC2054L	20"	54"	29"	160	19	\$1,137
☞ MMRC2436L	24"	36"	29"	140	15	\$1,174
☞ MMRC2442L	24"	42"	29"	150	18	\$1,205
☞ MMRC2448L	24"	48"	29"	160	20	\$1,218
☞ MMRC2454L	24"	54"	29"	170	23	\$1,281
☞ MMRC2460L	24"	60"	29"	180	24	\$1,294
☞ MMRC3048L	30"	48"	29"	175	25	\$1,294

Full modesty standard. ½ modesty on returns may be specified at no upcharge.
For handles and pedestal lock, add MMUHL3...\$88 (Specify H3B-H14, see p. 44).

maverick series

Returns

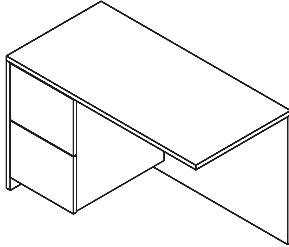

Return, File/File Pedestal Left (Full modesty)

Model#	Depth	Width	Height	Weight	Cube	Price
☞ MMRD2036L	20"	36"	29"	130	13	\$1,032
☞ MMRD2042L	20"	42"	29"	140	15	\$1,047
☞ MMRD2048L	20"	48"	29"	150	17	\$1,063
☞ MMRD2054L	20"	54"	29"	160	19	\$1,094
☞ MMRD2436L	24"	36"	29"	140	15	\$1,134
☞ MMRD2442L	24"	42"	29"	150	18	\$1,144
☞ MMRD2448L	24"	48"	29"	160	20	\$1,175
☞ MMRD2454L	24"	54"	29"	170	23	\$1,239
☞ MMRD2460L	24"	60"	29"	180	24	\$1,250
☞ MMRD3048L	30"	48"	29"	175	25	\$1,250

Full modesty standard. ½ modesty on returns may be specified at no upcharge.
For handles and pedestal lock, add MMUHL2...\$68 (Specify H3B-H14, see p. 44).

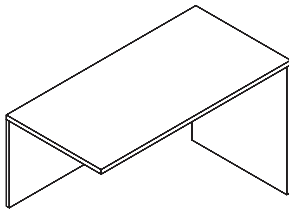

Return Shell Right (¼ Modesty)

Model#	Depth	Width	Height	Weight	Cube	Price
☞ MMRN2036R	20"	36"	29"	60	13	\$356
☞ MMRN2042R	20"	42"	29"	67	15	\$371
☞ MMRN2048R	20"	48"	29"	73	17	\$422
☞ MMRN2054R	20"	54"	29"	80	19	\$470
☞ MMRN2436R	24"	36"	29"	60	15	\$478
☞ MMRN2442R	24"	42"	29"	67	18	\$506
☞ MMRN2448R	24"	48"	29"	74	20	\$539
☞ MMRN2454R	24"	54"	29"	80	23	\$574
☞ MMRN3048R	30"	48"	29"	89	25	\$619

¼ modesty standard. ½ modesty on returns may be specified at no upcharge.
For full modesty panel upgrade, add MMFMP...\$64.

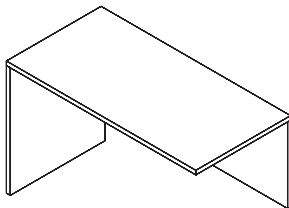

Return Shell Left (¼ Modesty)

Model#	Depth	Width	Height	Weight	Cube	Price
☞ MMRN2036L	20"	36"	29"	60	13	\$356
☞ MMRN2042L	20"	42"	29"	67	15	\$371
☞ MMRN2048L	20"	48"	29"	73	17	\$422
☞ MMRN2054L	20"	54"	29"	80	19	\$470
☞ MMRN2436L	24"	36"	29"	60	15	\$478
☞ MMRN2442L	24"	42"	29"	67	18	\$506
☞ MMRN2448L	24"	48"	29"	74	20	\$539
☞ MMRN2454L	24"	54"	29"	80	23	\$574
☞ MMRN3048L	30"	48"	29"	89	25	\$619

¼ modesty standard. ½ modesty on returns may be specified at no upcharge.
For full modesty panel upgrade, add MMFMP...\$64.

maverick series

Returns

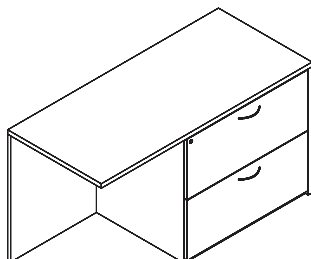

Return, Right 31"W Lateral File (H3B handles, lock, full modesty)

Model#	Depth	Width	Height	Weight	Cube	Price
MMRLF2054R	20"	54"	29"	192	19	\$1,390
MMRLF2060R	20"	60"	29"	198	21	\$1,400
MMRLF2454R	24"	54"	29"	201	23	\$1,460
MMRLF2460R	24"	60"	29"	208	25	\$1,500

H3S handles may be specified at no upcharge.

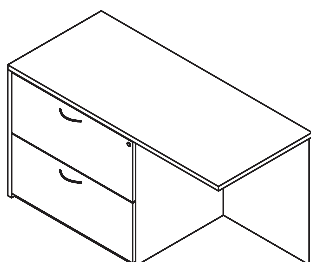

Return, Left 31"W Lateral File (H3B handles, lock, full modesty)

Model#	Depth	Width	Height	Weight	Cube	Price
MMRLF2054L	20"	54"	29"	192	19	\$1,390
MMRLF2060L	20"	60"	29"	198	21	\$1,400
MMRLF2454L	24"	54"	29"	201	23	\$1,460
MMRLF2460L	24"	60"	29"	208	25	\$1,500

H3S handles may be specified at no upcharge.

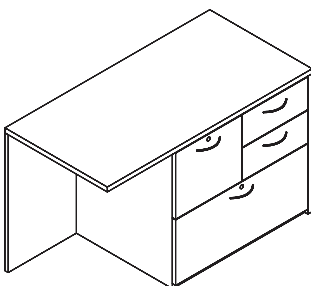

Return, Right 31"W Personal Lateral File (H3B handles, 2 locks, full modesty)

Model#	Depth	Width	Height	Weight	Cube	Price
MMRPLF2054R	20"	54"	29"	195	19	\$1,483
MMRPLF2060R	20"	60"	29"	201	23	\$1,535
MMRPLF2454R	24"	54"	29"	205	23	\$1,500
MMRPLF2460R	24"	60"	29"	213	28	\$1,567

Box drawers do not lock. H3S handles may be specified at no upcharge.

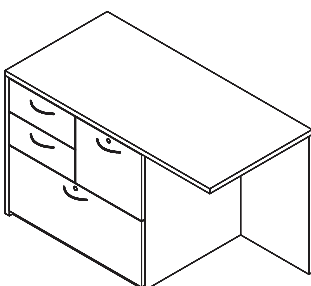

Return, Left 31"W Personal Lateral File (H3B handles, 2 locks, full modesty)

Model#	Depth	Width	Height	Weight	Cube	Price
MMRPLF2054L	20"	54"	29"	195	19	\$1,483
MMRPLF2060L	20"	60"	29"	201	23	\$1,535
MMRPLF2454L	24"	54"	29"	205	23	\$1,500
MMRPLF2460L	24"	60"	29"	213	28	\$1,567

Box drawers do not lock. H3S handles may be specified at no upcharge.

NOTE: Returns with personal lateral file, when ordering with APH1 handles (1) lock is standard.

maverick series

Credenzas

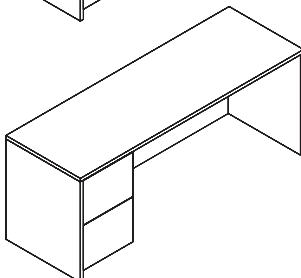
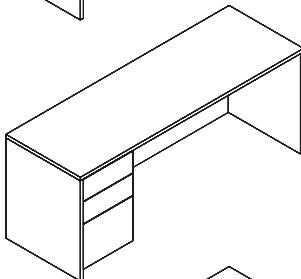
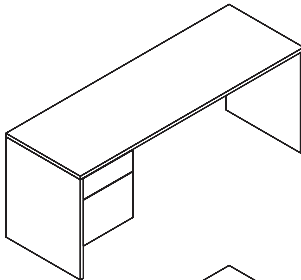
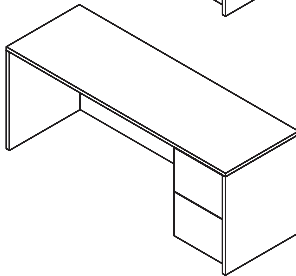
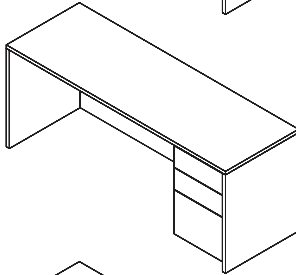
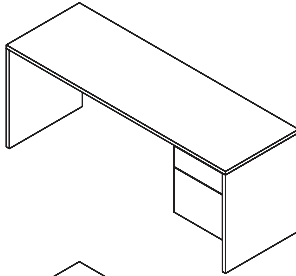

Credenza, Single Box/File Pedestal Right (¾ Modesty)

Model#	Depth	Width	Height	Weight	Cube	Price
☞ MMC2060 4R	20"	60"	29"	150	21	\$833
☞ MMC2066 4R	20"	66"	29"	157	23	\$936
☞ MMC2072 4R	20"	72"	29"	164	25	\$954
☞ MMC2472 4R	24"	72"	29"	168	30	\$983

For full modesty panel upgrade, add MMFMP...\$64.

For handles and pedestal lock, add MMUHL2...\$68 (Specify H3B-H14, see p. 44).

Credenza, Single Box/Box/File Pedestal Right (Full modesty)

Model#	Depth	Width	Height	Weight	Cube	Price
☞ MMCC2060 4R	20"	60"	29"	185	21	\$1,181
☞ MMCC2066 4R	20"	66"	29"	190	23	\$1,297
☞ MMCC2072 4R	20"	72"	29"	200	25	\$1,312
☞ MMCC2472 4R	24"	72"	29"	220	30	\$1,344

For handles and pedestal lock, add MMUHL3...\$88 (Specify H3B-H14, see p. 44).

Credenza, Single File/File Pedestal Right (Full modesty)

Model#	Depth	Width	Height	Weight	Cube	Price
☞ MMCD2060 4R	20"	60"	29"	183	21	\$1,137
☞ MMCD2066 4R	20"	66"	29"	190	23	\$1,256
☞ MMCD2072 4R	20"	72"	29"	200	25	\$1,271
☞ MMCD2472 4R	24"	72"	29"	220	30	\$1,302

For handles and pedestal lock, add MMUHL2...\$68 (Specify H3B-H14, see p. 44).

Credenza, Single Box/File Pedestal Left (¾ Modesty)

Model#	Depth	Width	Height	Weight	Cube	Price
☞ MMC2060 4L	20"	60"	29"	150	21	\$833
☞ MMC2066 4L	20"	66"	29"	157	23	\$936
☞ MMC2072 4L	20"	72"	29"	164	25	\$954
☞ MMC2472 4L	24"	72"	29"	168	30	\$983

For full modesty panel upgrade, add MMFMP...\$64.

For handles and pedestal lock, add MMUHL2...\$68 (Specify H3B-H14, see p. 44).

Credenza, Single Box/Box/File Pedestal Left (Full modesty)

Model#	Depth	Width	Height	Weight	Cube	Price
☞ MMCC2060 4L	20"	60"	29"	183	21	\$1,181
☞ MMCC2066 4L	20"	66"	29"	190	23	\$1,297
☞ MMCC2072 4L	20"	72"	29"	200	25	\$1,312
☞ MMCC2472 4L	24"	72"	29"	220	30	\$1,344

For handles and pedestal lock, add MMUHL3...\$88 (Specify H3B-H14, see p. 44).

Credenza, Single File/File Pedestal Left (Full modesty)

Model#	Depth	Width	Height	Weight	Cube	Price
☞ MMCD2060 4L	20"	60"	29"	183	21	\$1,137
☞ MMCD2066 4L	20"	66"	29"	190	23	\$1,256
☞ MMCD2072 4L	20"	72"	29"	200	25	\$1,271
☞ MMCD2472 4L	24"	72"	29"	220	30	\$1,302

For handles and pedestal lock, add MMUHL2...\$68 (Specify H3B-H14, see p. 44).

maverick series

Credenzas

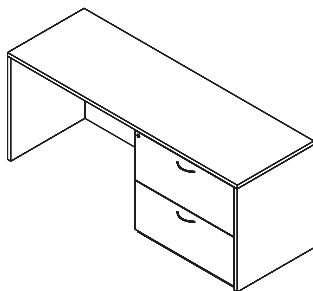

Credenza, 36"W Lateral File Pedestal Right (H3B handles, lock, full modesty)

Model#	Depth	Width	Height	Weight	Cube	Price
MMC2066 5R	20"	66"	29"	223	23	\$1,507
MMC2072 5R	20"	72"	29"	230	25	\$1,523
MMC2472 5R	24"	72"	29"	270	30	\$1,596

Upgrade to H3S handles...N/C.

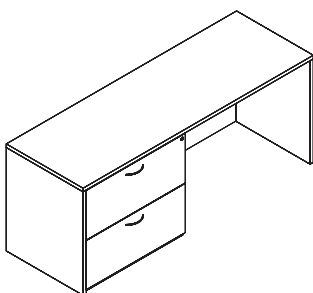

Credenza, 36"W Lateral File Pedestal Left (H3B handles, lock, full modesty)

Model#	Depth	Width	Height	Weight	Cube	Price
MMC2066 5L	20"	66"	29"	223	23	\$1,507
MMC2072 5L	20"	72"	29"	230	25	\$1,523
MMC2472 5L	24"	72"	29"	270	30	\$1,596

Upgrade to H3S handles...N/C.

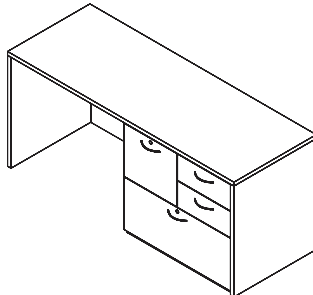

Credenza, 31"W Personal Lateral File Pedestal Right (H3B handles, locks, full modesty)

Model#	Depth	Width	Height	Weight	Cube	Price
MMC2066 6R	20"	66"	29"	230	26	\$1,717
MMC2072 6R	20"	72"	29"	236	28	\$1,739
MMC2472 6R	24"	72"	29"	260	30	\$1,813

Box drawers do not lock. Upgrade to H3S handles...N/C.

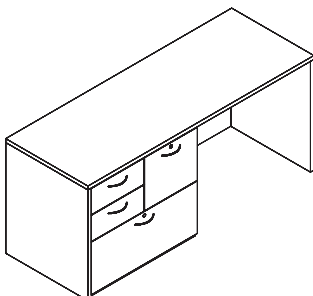

Credenza, 31"W Personal Lateral File Pedestal Left (H3B handles, locks, full modesty)

Model#	Depth	Width	Height	Weight	Cube	Price
MMC2066 6L	20"	66"	29"	230	26	\$1,717
MMC2072 6L	20"	72"	29"	236	28	\$1,739
MMC2472 6L	24"	72"	29"	260	30	\$1,813

Box drawers do not lock. Upgrade to H3S handles...N/C.

NOTE: Credenzas with personal lateral file, when ordering with APH1 handles (1) lock is standard.

maverick series

CompuCorner Credenzas

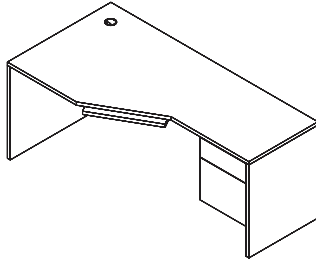

Computer Corner, Box/File Pedestal Right (¼ Modesty)

Model#	(L)	(B)	(E)	(K)	(R)	(W)	Weight	Cube	Price
☞ MMCD66 4R	66"	36"	24"	21"	24"	24"	229	42	\$1,117
☞ MMCD72 3R	72"	36"	20"	24"	20"	33"	249	45	\$1,186
☞ MMCD72 4R	72"	36"	24"	21"	24"	30"	249	45	\$1,066
☞ MMCD72 7R	72"	36"	24"	23"	20"	32"	285	45	\$1,169
☞ MMCD72 8R	72"	42"	24"	24"	24"	33"	285	53	\$1,432

For full modesty panel upgrade, add MMFMP...\$64.
 Keyboard tray and worksurface black grommet standard.
 Upgrade grommet cover to silver, N/C.
 For handles and pedestal lock, add MMUHL2...\$68 (Specify H3B-H14, see p. 44).

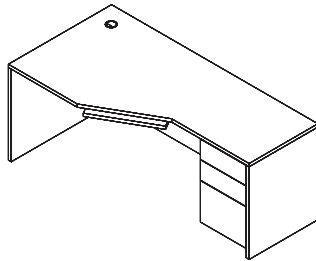

Computer Corner, Box/Box/File Pedestal Right (Full modesty)

Model#	(L)	(B)	(E)	(K)	(R)	(W)	Weight	Cube	Price
☞ MMCD66C 4R	66"	36"	24"	21"	24"	24"	245	42	\$1,478
☞ MMCD72C 3R	72"	36"	20"	24"	20"	33"	265	45	\$1,545
☞ MMCD72C 4R	72"	36"	24"	21"	24"	30"	265	45	\$1,425
☞ MMCD72C 7R	72"	36"	24"	23"	20"	32"	300	45	\$1,530
☞ MMCD72C 8R	72"	42"	24"	24"	24"	33"	300	53	\$1,794

Keyboard tray and worksurface black grommet standard. Upgrade grommet cover to silver, N/C.
 For handles and pedestal lock, add MMUHL3...\$88. (Specify H3B-H14, see p. 44).

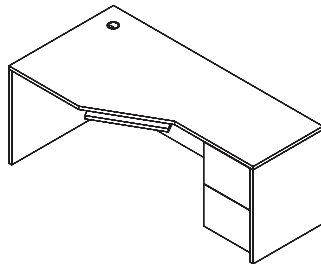

Computer Corner, File/File Pedestal Right (Full modesty)

Model#	(L)	(B)	(E)	(K)	(R)	(W)	Weight	Cube	Price
☞ MMCD66D 4R	66"	36"	24"	21"	24"	24"	245	42	\$1,382
☞ MMCD72D 3R	72"	36"	20"	24"	20"	33"	265	45	\$1,450
☞ MMCD72D 4R	72"	36"	24"	21"	24"	30"	265	45	\$1,382
☞ MMCD72D 7R	72"	36"	24"	23"	20"	32"	300	45	\$1,486
☞ MMCD72D 8R	72"	42"	24"	24"	24"	33"	300	53	\$1,750

Keyboard tray and worksurface black grommet standard. Upgrade grommet cover to silver, N/C.
 For handles and pedestal lock, add MMUHL2...\$68. (Specify H3B-H14, see p. 44).



"L" Length along approach edge
 "B" Back end panel
 "E" End panel
 "K" Keyboard space
 "R" Return depth to attach
 "W" Workarea (kbrd to end)

maverick series

CompuCorner Credenzas

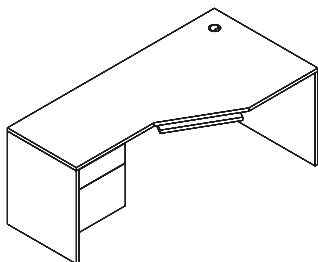

Computer Corner, Box/File Pedestal Left (3/4 Modesty)

Model#	(L)	(B)	(E)	(K)	(R)	(W)	Weight	Cube	Price
☞ MMCD66 4L	66"	36"	24"	21"	24"	24"	229	42	\$1,117
☞ MMCD72 3L	72"	36"	20"	24"	20"	33"	249	45	\$1,186
☞ MMCD72 4L	72"	36"	24"	21"	24"	30"	249	45	\$1,066
☞ MMCD72 7L	72"	36"	24"	23"	20"	32"	285	45	\$1,169
☞ MMCD72 8L	72"	42"	24"	24"	24"	33"	285	53	\$1,432

For full modesty panel upgrade, add MMFMP...\$64.
 Keyboard tray and worksurface black grommet standard.
 Upgrade grommet cover to silver, N/C.
 For handles and pedestal lock, add MMUHL2...\$68 (Specify H3B-H14, see p. 44).

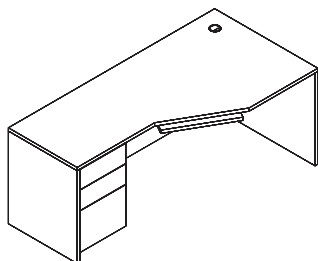

Computer Corner, Box/Box/File Pedestal Left (Full modesty)

Model#	(L)	(B)	(E)	(K)	(R)	(W)	Weight	Cube	Price
☞ MMCD66C 4L	66"	36"	24"	21"	24"	24"	245	42	\$1,478
☞ MMCD72C 3L	72"	36"	20"	24"	20"	33"	265	45	\$1,545
☞ MMCD72C 4L	72"	36"	24"	21"	24"	30"	265	45	\$1,425
☞ MMCD72C 7L	72"	36"	24"	23"	20"	32"	300	45	\$1,530
☞ MMCD72C 8L	72"	42"	24"	24"	24"	33"	300	53	\$1,794

Keyboard tray and worksurface black grommet standard. Upgrade grommet cover to silver, N/C.
 For handles and pedestal lock, add MMUHL3...\$88. (Specify H3B-H14, see p. 44).

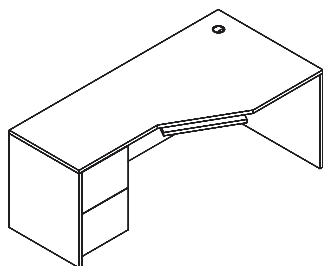

Computer Corner, File/File Pedestal Left (Full modesty)

Model#	(L)	(B)	(E)	(K)	(R)	(W)	Weight	Cube	Price
☞ MMCD66D 4L	66"	36"	24"	21"	24"	24"	245	42	\$1,382
☞ MMCD72D 3L	72"	36"	20"	24"	20"	33"	265	45	\$1,450
☞ MMCD72D 4L	72"	36"	24"	21"	24"	30"	265	45	\$1,382
☞ MMCD72D 7L	72"	36"	24"	23"	20"	32"	300	45	\$1,486
☞ MMCD72D 8L	72"	42"	24"	24"	24"	33"	300	53	\$1,750

Keyboard tray and worksurface black grommet standard. Upgrade grommet cover to silver, N/C.
 For handles and pedestal lock, add MMUHL2...\$68. (Specify H3B-H14, see p. 44).

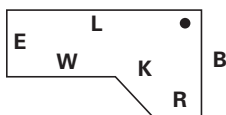

"L" Length along approach edge
 "B" Back end panel
 "E" End panel
 "K" Keyboard space
 "R" Return depth to attach
 "W" Workarea (kbrd to end)

maverick series

CompuCorner Credenzas

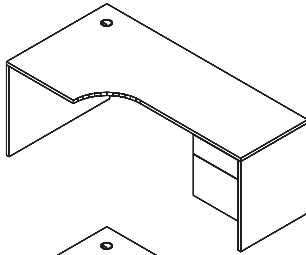

Computer Corner, Curved, 3/4 Box/File Pedestal Right (3/4 Modesty)

Model#	(L)	(B)	(E)	(K)	(R)	(W)	Weight	Cube	Price
MMCDQ72 4R	72"	36"	24"	21"	24"	30"	239	45	\$1,066

No keyboard tray. Worksurface black grogmet standard. Upgrade grogmet cover to silver, N/C.
For handles and pedestal lock, add MMUHL2...\$68. (Specify H3B-H14, see p. 44).
For full modesty panel upgrade, add MMFMP...\$64.

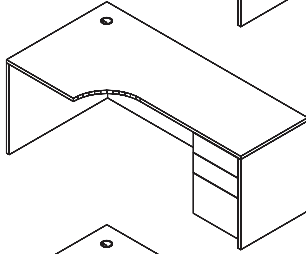

Computer Corner, Curved, Box/Box/File Pedestal Right (Full modesty)

Model#	(L)	(B)	(E)	(K)	(R)	(W)	Weight	Cube	Price
MMCDQ72C 4R	72"	36"	24"	21"	24"	30"	254	45	\$1,425

No keyboard tray. Worksurface black grogmet standard. Upgrade grogmet cover to silver, N/C.
For handles and pedestal lock, add MMUHL3...\$88. (Specify H3B-H14, see p. 44).

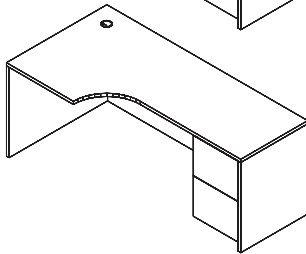

Computer Corner, Curved, File/File Pedestal Right (Full modesty)

Model#	(L)	(B)	(E)	(K)	(R)	(W)	Weight	Cube	Price
MMCDQ72D 4R	72"	36"	24"	21"	24"	30"	254	45	\$1,383

No keyboard tray. Worksurface black grogmet standard. Upgrade grogmet cover to silver, N/C.
For handles and pedestal lock, add MMUHL2...\$68. (Specify H3B-H14, see p. 44).

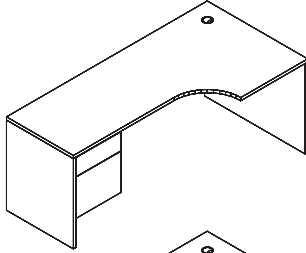

Computer Corner, Curved, 3/4 Box/File Pedestal Left (3/4 Modesty)

Model#	(L)	(B)	(E)	(K)	(R)	(W)	Weight	Cube	Price
MMCDQ72 4L	72"	36"	24"	21"	24"	30"	239	45	\$1,066

No keyboard tray. Worksurface black grogmet standard. Upgrade grogmet cover to silver, N/C.
For handles and pedestal lock, add MMUHL2...\$68. (Specify H3B-H14, see p. 44).
For full modesty panel upgrade, add MMFMP...\$64.

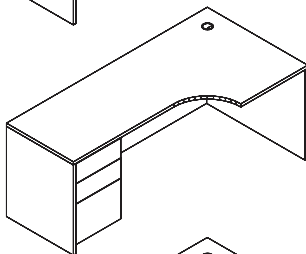

Computer Corner, Curved, Box/Box/File Pedestal Left (Full modesty)

Model#	(L)	(B)	(E)	(K)	(R)	(W)	Weight	Cube	Price
MMCDQ72C 4L	72"	36"	24"	21"	24"	30"	254	45	\$1,425

No keyboard tray. Worksurface black grogmet standard. Upgrade grogmet cover to silver, N/C.
For handles and pedestal lock, add MMUHL3...\$88. (Specify H3B-H14, see p. 44).

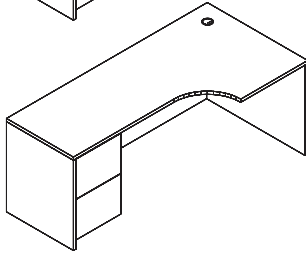

Computer Corner, Curved, File/File Pedestal Left (Full modesty)

Model#	(L)	(B)	(E)	(K)	(R)	(W)	Weight	Cube	Price
MMCDQ72D 4L	72"	36"	24"	21"	24"	30"	254	45	\$1,383

No keyboard tray. Worksurface black grogmet standard. Upgrade grogmet cover to silver, N/C.
For handles and pedestal lock, add MMUHL2...\$68. (Specify H3B-H14, see p. 44).

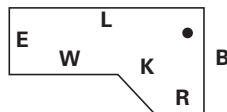

- "L" Length along approach edge
- "B" Back end panel
- "E" End panel
- "K" Keyboard space
- "R" Return depth to attach
- "W" Workarea (kbrd to end)

See available accessories and upgrades, pp. 53-56.

maverick series

CompuCorner Credenzas

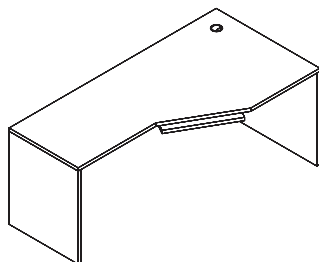

Computer Corner Shell (¾ Modesty) For Right Return

Model#	(L)	(B)	(E)	(K)	(R)	(W)	Weight	Cube	Price
☞ MMCDN60 2R	60"	30"	20"	21"	20"	21"	184	32	\$786
☞ MMCDN72 3R	72"	36"	20"	24"	20"	33"	213	45	\$921
☞ MMCDN72 4R	72"	36"	24"	21"	24"	30"	213	45	\$954

Keyboard tray and worksurface black grommet standard. Upgrade grommet cover to silver, N/C. For full modesty panel upgrade, add MMFMP...\$64.

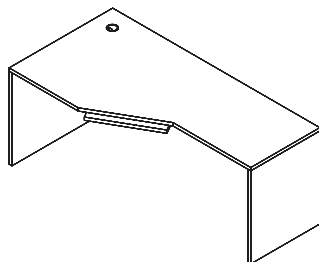

Computer Corner Shell (¾ Modesty) For Left Return

Model#	(L)	(B)	(E)	(K)	(R)	(W)	Weight	Cube	Price
☞ MMCDN60 2L	60"	30"	20"	21"	20"	21"	184	32	\$786
☞ MMCDN72 3L	72"	36"	20"	24"	20"	33"	213	45	\$921
☞ MMCDN72 4L	72"	36"	24"	21"	24"	30"	213	45	\$954

Keyboard tray and worksurface black grommet standard. Upgrade grommet cover to silver, N/C. For full modesty panel upgrade, add MMFMP...\$64.

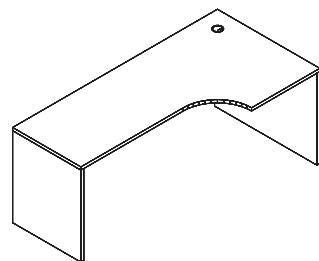

Computer Corner Shell, Curved (¾ Modesty) For Right Return

Model#	(L)	(B)	(E)	(K)	(R)	(W)	Weight	Cube	Price
☞ MMCDNQ72 4R	72"	36"	24"	21"	24"	30"	213	45	\$954

Worksurface black grommet standard. No keyboard tray. Upgrade grommet cover to silver, N/C. For full modesty panel upgrade, add MMFMP...\$64.

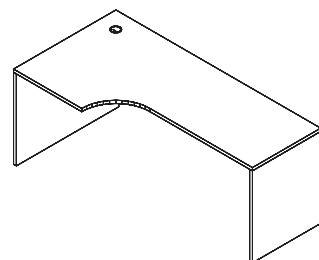

Computer Corner Shell, Curved (¾ Modesty) For Left Return

Model#	(L)	(B)	(E)	(K)	(R)	(W)	Weight	Cube	Price
☞ MMCDNQ72 4L	72"	36"	24"	21"	24"	30"	213	45	\$954

Worksurface black grommet standard. No keyboard tray. Upgrade grommet cover to silver, N/C. For full modesty panel upgrade, add MMFMP...\$64.

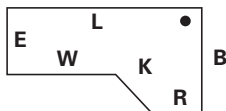

- "L" Length along approach edge
- "B" Back end panel
- "E" End panel
- "K" Keyboard space
- "R" Return depth to attach
- "W" Workarea (kbd to end)

maverick series

CompuCorner Credenzas

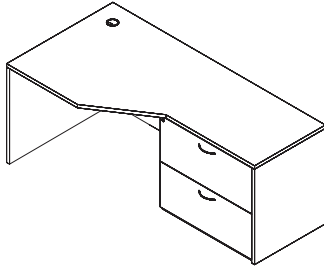

Computer Corner, Right 31" W Lateral File (H3B handles, lock, full modesty)

Model#	(L)	(B)	(E)	(K)	(R)	(W)	Weight	Cube	Price
MMCD72LF 3R	72"	36"	20"	24"	20"	33"	249	45	\$1,582
MMCD72LF 4R	72"	36"	24"	21"	24"	30"	265	45	\$1,671

No keyboard tray. Worksurface black grommet standard. Upgrade to H3S handles...N/C. Upgrade grommet cover to silver, N/C.

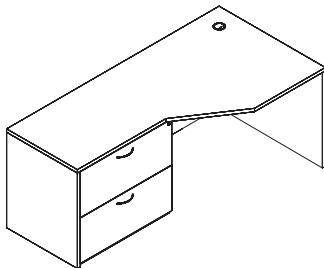

Computer Corner, Left 31" W Lateral File (H3B handles, lock, full modesty)

Model#	(L)	(B)	(E)	(K)	(R)	(W)	Weight	Cube	Price
MMCD72LF 3L	72"	36"	20"	24"	20"	33"	249	45	\$1,582
MMCD72LF 4L	72"	36"	24"	21"	24"	30"	265	45	\$1,671

No keyboard tray. Worksurface black grommet standard. Upgrade to H3S handles...N/C. Upgrade grommet cover to silver, N/C.

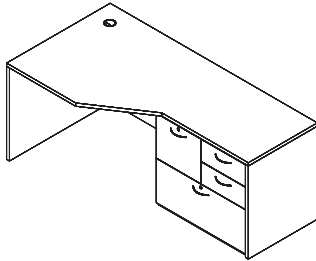

Computer Corner, Right 31" W Personal Lateral File (H3B handles, locks, full modesty)

Model#	(L)	(B)	(E)	(K)	(R)	(W)	Weight	Cube	Price
MMCD72PLF 3R	72"	36"	20"	24"	20"	33"	249	45	\$1,756
MMCD72PLF 4R	72"	36"	24"	21"	24"	30"	265	45	\$1,800

No keyboard tray. Worksurface black grommet standard. Box drawers do not lock. Upgrade to H3S handles...N/C. Upgrade grommet cover to silver, N/C.

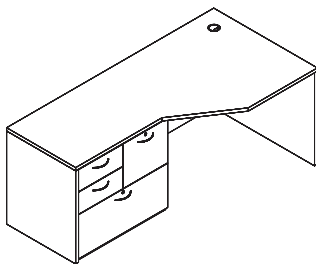

Computer Corner, Left 31" W Personal Lateral File (H3B handles, locks, full modesty)

Model#	(L)	(B)	(E)	(K)	(R)	(W)	Weight	Cube	Price
MMCD72PLF 3L	72"	36"	20"	24"	20"	33"	249	45	\$1,756
MMCD72PLF 4L	72"	36"	24"	21"	24"	30"	265	45	\$1,800

No keyboard tray. Worksurface black grommet standard. Box drawers do not lock. Upgrade to H3S handles...N/C. Upgrade grommet cover to silver, N/C.

NOTE: Computer Corners with personal lateral file, when ordering with APH1 Handles (1) lock is standard.

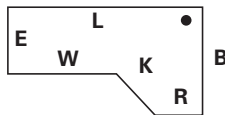

- "L" Length along approach edge
- "B" Back end panel
- "E" End panel
- "K" Keyboard space
- "R" Return depth to attach
- "W" Workarea (kbrd to end)

maverick series

Credenzas

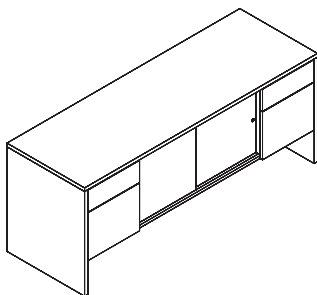

Credenza Double Pedestal, Box/File Left and Right, Center Storage (Sliding doors, ¾ modesty)

Model#	Depth	Width	Height	Weight	Cube	Price
☞ MMC2060 2	20"	60"	29"	230	21	\$1,101
☞ MMC2066 2	20"	66"	29"	240	23	\$1,305
☞ MMC2072 2	20"	72"	29"	250	25	\$1,318
☞ MMC2472 2	24"	72"	29"	270	30	\$1,402

Storage includes one adjustable ¾"-thick shelf.
For handles and pedestal lock, add MMUHL2...\$68 each pedestal (Specify H3B-H14, see p. 44).
NOTE: Ped lock is inside doors.

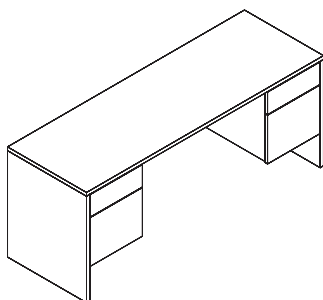

Credenza Double Pedestal, Box/File Left and Right (Knee space, ¾ modesty)

Model#	Depth	Width	Height	Weight	Cube	Price
☞ MMC2060 3	20"	60"	29"	196	21	\$1,020
☞ MMC2066 3	20"	66"	29"	205	23	\$1,229
☞ MMC2072 3	20"	72"	29"	210	25	\$1,253
☞ MMC2472 3	24"	72"	29"	230	30	\$1,288

For full modesty panel upgrade, add MMFMP...\$64.
For handles and pedestal lock, add MMUHL2...\$68 each pedestal (Specify H3B-H14, see p. 44).

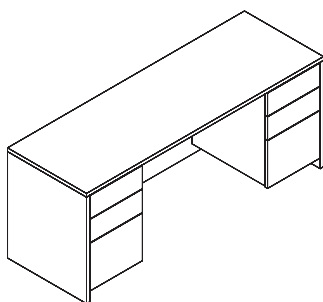

Credenza Double Pedestal, Box/Box/File Left and Right (Knee space, full modesty)

Model#	Depth	Width	Height	Weight	Cube	Price
☞ MMCC2060 3	20"	60"	29"	245	21	\$1,380
☞ MMCC2066 3	20"	66"	29"	255	23	\$1,592
☞ MMCC2072 3	20"	72"	29"	265	25	\$1,613
☞ MMCC2472 3	24"	72"	29"	290	30	\$1,649

For handles and pedestal lock, add MMUHL3...\$88 each pedestal (Specify H3B-H14, see p. 44).
For Left Box/Box/File & Right File/File configuration, use model# MMCCD_ _ _ _ 3. N/C.

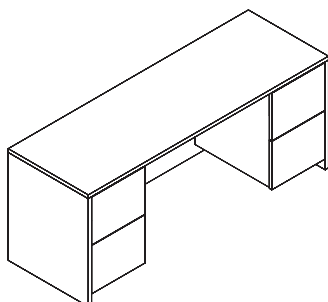

Credenza Double Pedestal, File/File Left and Right (Knee space, full modesty)

Model#	Depth	Width	Height	Weight	Cube	Price
☞ MMCD2060 3	20"	60"	29"	245	21	\$1,336
☞ MMCD2066 3	20"	66"	29"	255	23	\$1,550
☞ MMCD2072 3	20"	72"	29"	265	25	\$1,571
☞ MMCD2472 3	24"	72"	29"	290	30	\$1,607

For handles and pedestal lock, add MMUHL2...\$68 each pedestal (Specify H3B-H14, see p. 44).

maverick series

Credenzas

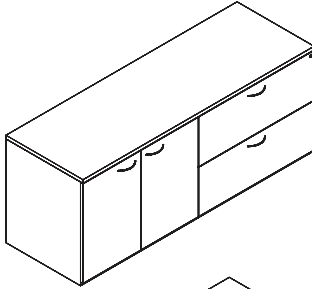

Credenza, Hinged Door Cabinet Left and Lateral File Right (H3B handles, lateral file lock)

Model#	Depth	Width	Height	Weight	Cube	Price
MMC2072 9FP	20"	72"	29"	270	30	\$1,861
MMC2472 9FP	24"	72"	29"	290	30	\$1,912

Cabinet includes 1 adjustable shelf $\frac{3}{4}$ " thick.
Optional face lock for hinged doors, add MMFL...\$78. Upgrade to H3S handles...N/C.

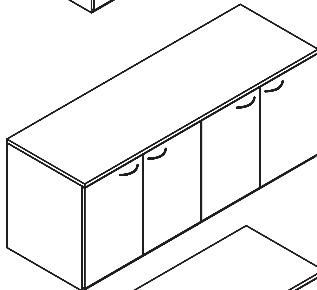

Credenza, 4- Full Hinged Door (2 adjustable shelves, H3B handles)

Model#	Depth	Width	Height	Weight	Cube	Price
MMC2048 1FP	20"	48"	29"	155	17	\$1,470
MMC2448 1FP	24"	48"	29"	175	20	\$1,545
MMC2060 1FP	20"	60"	29"	220	21	\$1,582
MMC2066 1FP	20"	66"	29"	240	23	\$1,717
MMC2072 1FP	20"	72"	29"	260	25	\$1,739
MMC2472 1FP	24"	72"	29"	295	30	\$1,890
MMC207236 1FP	20"	72"	36"	238	30	\$1,875
MMC247236 1FP	24"	72"	36"	265	36	\$1,975

Storage includes 1 adjustable shelf $\frac{3}{4}$ " thick.
Optional face locks (2 locks required), add MMFL...\$78 each.
Upgrade to H3S handles...N/C.

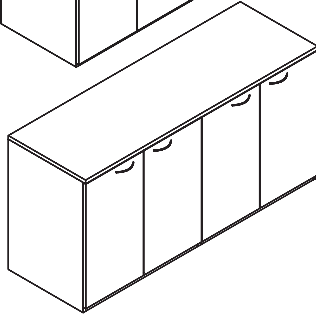

Buffet Credenza (4 box drawers, 4 full hinged doors, 2 adjustable shelves, H3B handles)

Model#	Depth	Width	Height	Weight	Cube	Price
MMHDBC2036	20"	36"	36"	220	15	\$1,145
MMHDBC2436	24"	36"	36"	240	18	\$1,258
MMHDBC2060	20"	60"	36"	236	25	\$2,345
MMHDBC2460	24"	60"	36"	261	30	\$2,440
MMHDBC2072	20"	72"	36"	260	30	\$2,372
MMHDBC2472	24"	72"	36"	290	36	\$2,476

Storage includes 1 adjustable shelf $\frac{3}{4}$ " thick per side.
36"W credenza: 2 box drawers & 2 hinged doors, 1 adjustable shelf.
Optional face locks (2 locks required for doors...1 lock per box drawer), add MMFL...\$78 each.
(Optional face lock for 36"W requires 1 for doors and 1 for each box drawers.)
Upgrade to H3S handles...N/C.

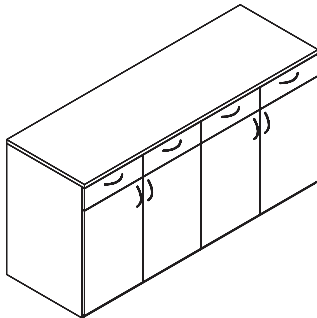

Buffet Credenza (4 box drawers, full hinged glass doors, 2 adjustable shelves, H3B handles)

Model#	Depth	Width	Height	Weight	Cube	Price
MMHDBC2036G	20"	36"	36"	220	15	\$1,442
MMHDBC2436G	24"	36"	36"	240	18	\$1,550
MMHDBC2072G	20"	72"	36"	240	18	\$3,232
MMHDBC2472G	24"	72"	36"	290	36	\$3,334

Storage includes 1 adjustable shelf $\frac{3}{4}$ " thick per side.
36"W credenza: 2 box drawers & 2 glass doors, 1 adjustable shelf.
Optional face locks for box drawers, add MMFL...\$78 each.
Locks N/A for glass doors. Upgrade to H3S handles...N/C.

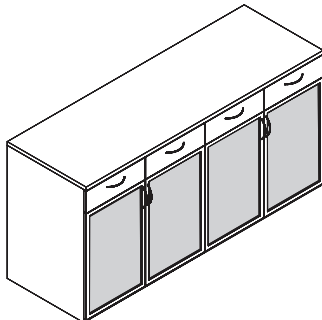

maverick series

Hutches

(Maverick Series hutch fits Maverick Series worksurfaces only)

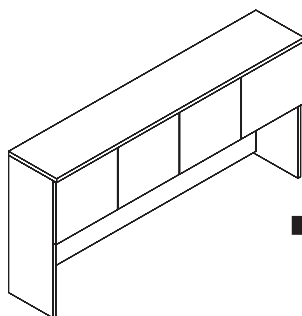

Hutch, with Four Hinged Doors (19" below doors)

Model#	Depth	Width	Height	Weight	Cube	Price
MMH48 WD	14"	48"	36"	130	14	\$1,020
MMH60 WD	14"	60"	36"	155	18	\$1,101
MMH66 WD	14"	66"	36"	167	20	\$1,199
MMH72 WD	14"	72"	36"	179	21	\$1,229
Glass Doors MMH72 WG	14"	72"	36"	179	21	\$1,750

Optional face locks (2 locks required), add MMFL...\$78 each. Glass doors do NOT lock.
May be upgraded to 42" height, add MMUHH...\$176. Add tasklights, fascia and tackboards, see p. 43.
Ends are 3/4" thick; doors overlay legs but are inset to the 1"-thick top. 3/4" back panel cord gap.

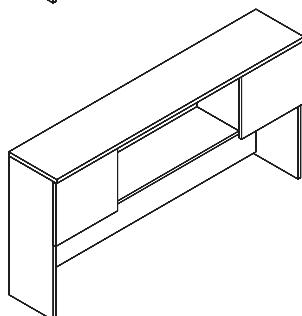

Hutch, Left & Right Hinged Doors, Center Opening (19" below doors)

Model#	Depth	Width	Height	Weight	Cube	Price
MMH60 W2D	14"	60"	36"	140	18	\$ 996
MMH66 W2D	14"	66"	36"	152	20	\$1,050
MMH72 W2D	14"	72"	36"	164	21	\$1,101

Optional face locks (2 locks required), add MMFL...\$78 each. Doors are same width as open space.
May be upgraded to 42" height, add MMUHH...\$176. Add tasklights, fascia and tackboards, see p. 43.
Ends are 3/4" thick; doors overlay legs but are inset to the 1"-thick top. 3/4" back panel cord gap.

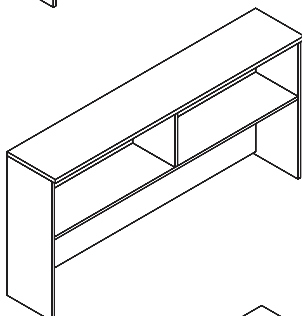

Hutch, No Doors (20" below shelf)

Model#	Depth	Width	Height	Weight	Cube	Price
MMH48 ND	14"	48"	36"	115	14	\$735
MMH60 ND	14"	60"	36"	135	18	\$764
MMH66 ND	14"	66"	36"	148	20	\$832
MMH72 ND	14"	72"	36"	160	21	\$921

May be upgraded to 42" height, add MMUHH...\$176. Add tasklights, fascia and tackboards, see p. 43.
Ends are 3/4" thick; doors overlay legs but are inset to the 1"-thick top. 3/4" back panel cord gap.

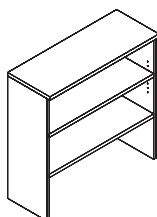

Bookcase Hutch, Full Back Panel

(One adjustable shelf, one fixed shelf, 1"-thick shelves) Bottom clearance 12"H

Model#	Depth	Width	Height	# Shelves	Weight	Cube	Price
MMBCH31	14"	31"	36"	2	81	10	\$430
MMBCH	14"	36"	36"	2	72	11	\$450

May be upgraded to 42" height, add MMUHH...\$176. 12"H Bottom clearance does not change. See p. 43.
Ends are 3/4" thick; legs are inset to the 1"-thick top. Width coordinates with lateral files and utility cabinets.

Wall Mount Cabinets

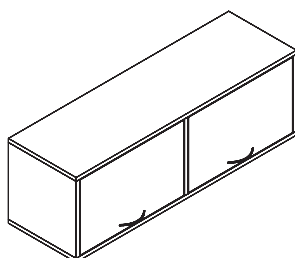

Wall Mount Overhead Cabinet With Flip Doors, H3B handles (35lb. weight capacity)

Model#	Depth	Width	Height	# of Doors	Weight	Cube	Price
MMCFOHB30	14 3/4"	30"	16"	1	110	7	\$ 812
MMCFOHB36	14 3/4"	36"	16"	1	110	7	\$ 919
MMCFOHB48	14 3/4"	48"	16"	2	110	7	\$1,087

Optional locks (2 required on 48"W), add MMFL...\$78 each.
H3S handles may be added at no upcharge.
Requires professional installation and must be mounted to wall stud.
35lb. weight capacity.

maverick series

Wall Mount Cabinets

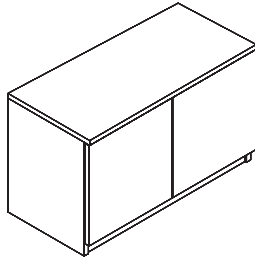

Wall Mount Overhead Cabinet with Hinged Door Overlay, Finger pull, Fascia (35lb. weight capacity)

Model#	Depth	Width	Height	# of Doors	Weight	Cube	Price
MMCFOHD30	14 3/4"	30"	18 1/2"	2	110	7	\$789
MMCFOHD36	14 3/4"	36"	18 1/2"	2	110	7	\$812
MMCFOHD42	14 3/4"	42"	18 1/2"	2	120	9	\$932
MMCFOHD48	14 3/4"	48"	18 1/2"	4	120	9	\$960

Wall mount overhead storage includes fascia. Optional handles may be added. Optional face lock (2 face locks are required for 42"W & 48"W) add MMFL...\$78 each. Requires professional installation and must be mounted to wall stud. 35lb. weight capacity.

Storage

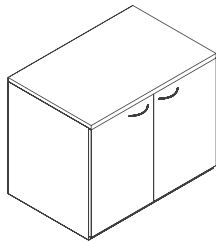

Hinged Door Utility Cabinet (H3B handle, one 3/4"-thick adjustable shelf)

Model#	Depth	Width	Height	Weight	Cube	Price
MMHDC2036	20"	36"	29"	115	13	\$ 786
MMHDC2042	20"	42"	29"	165	15	\$ 832
MMHDC2436	24"	36"	29"	175	15	\$ 908
MMHDC2442	24"	42"	29"	180	18	\$ 983
MMHDC2436G	24"	36"	29"	175	18	\$1,226

Glass Doors

Optional lock available, add MMFL...\$78. Width coordinates with bookcase hutch. Upgrade to H3S handles...N/C. Glass doors do NOT lock.

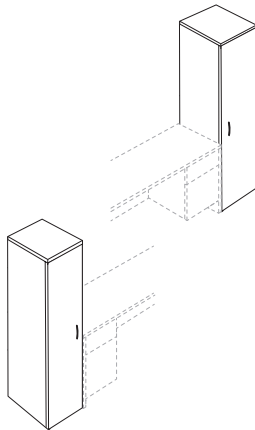

Single Storage Cabinet, Right (H3B handle, three adjustable 3/4"-thick shelves)

Model#	Depth	Width	Height	Weight	Cube	Price
MMSTS1665R	20"	16"	65"	185	12	\$983

Optional lock available, add MMFL...\$78. Upgrade to H3S handles...N/C. Add \$61 List for H30 Handle.

Single Storage Cabinet, Left (H3B handle, three adjustable 3/4"-thick shelves)

Model#	Depth	Width	Height	Weight	Cube	Price
MMSTS1665L	20"	16"	65"	185	12	\$983

Optional lock available, add MMFL...\$78. Upgrade to H3S handles...N/C. Add \$61 List for H30 Handle.

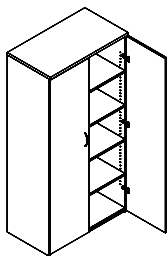

Double Storage Cabinet (3/4"-thick adjustable shelves, H3B handles)

Model#	Depth	Width	Height	# Shelves	Weight	Cube	Price
MMST3642	20"	36"	42"	2	208	18	\$1,095
MMST3665	20"	36"	65"	3	290	27	\$1,508
MMST3672	20"	36"	72"	4	370	30	\$1,700
MMST3684	20"	36"	84"	5	298	35	\$1,920
MMST243665	24"	36"	65"	3	290	33	\$1,680
MMST243672	24"	36"	72"	4	370	36	\$1,855

Optional lock available, add MMFL...\$78. Upgrade to H3S handles...N/C. Add \$61 List for H30 Handle. Cabinets 60"H & higher require fixed shelf for locking.

maverick series

Storage

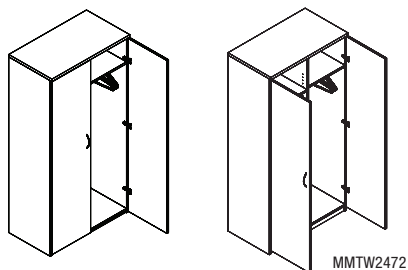

Wardrobe Cabinet (Coat rack, one fixed shelf, H3B handles)

Model#	Depth	Width	Height	Weight	Cube	Price
MMWC3665	24"	36"	65"	309	33	\$1,308
MMWC3672	24"	36"	72"	325	36	\$1,523
MMTW2472	24"	36"	72"	286	36	\$1,940

MMTW2472: Left 4 adjustable shelves, right wardrobe. Requires 2 locks.
Optional lock, add MMFL...\$78 ea. Upgrade to H3S handles...N/C. For H30 Handle, add...\$61 each.

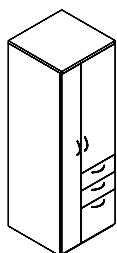

Personal Storage Cabinet

(Right door, 2 adjustable shelves and Box/Box/File pedestal, left door, H3B handles)

Model#	Depth	Width	Height	Weight	Cube	Price
MMWCP2465	24"	24"	65"	309	22	\$2,004
MMWCP2472	24"	24"	72"	325	24	\$2,167

Coat rack in long compartment. Optional face lock (2 locks required for doors), add MMFL...\$78 each.
For pedestal face lock, add MMFFL \$156 List. Upgrade to H3S handles...N/C.

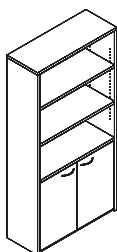

Bookcase with Storage Cabinet (1"-thick adjustable shelves, H3B handles)

Model#	Depth	Width	Height	# Shelves	Weight	Cube	Price
MMBCD3660	14"	36"	60"	2	135	18	\$1,186
MMBCD3672	14"	36"	72"	3	145	21	\$1,229
MMBCD3684	14"	36"	84"	4	155	25	\$1,418

Optional lock, add MMFL...\$78. Upgrade to H3S handles...N/C.

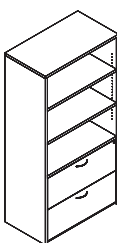

Bookcase with 36" Wide Lateral File (1"-thick adjustable shelves, lock, H3B handles)

Model#	Depth	Width	Height	# Shelves	Weight	Cube	Price
MMBCLF3660	20"	36 1/2"	60"	1	224	25	\$1,620
MMBCLF3672	20"	36 1/2"	72"	2	260	30	\$1,702
MMBCLF3684	20"	36 1/2"	84"	3	281	35	\$1,875

For H30 Handle, add...\$61 each. Upgrade to H3S handles...N/C.

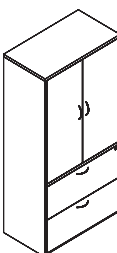

Bookcase with 36" Wide Lateral File & Doors (1"-thick adjustable shelves, one lock, H3B handles)

Model#	Depth	Width	Height	# Shelves	Weight	Cube	Price
MMBCLF3672WD	20"	36 1/2"	72"	2	300	30	\$2,061
MMBCLF3684WD	20"	36 1/2"	84"	3	331	35	\$2,299

For H30 Handle, add...\$61 each. Upgrade to H3S handles...N/C.
Lateral file with lock. Optional face lock for doors, add MMFL \$78 List.

maverick series

Storage

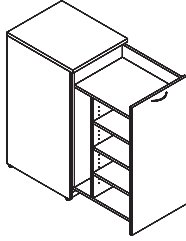

Slide Out Personal Storage Cabinet, Right Door Slide Out Storage (H3B handles)

Model#	Depth	Width	Height	Weight	Cube	Price
MMSDS2442R	24"	20 1/2"	42"	200	12	\$2,085
MMSDS3042R	30"	20 1/2"	42"	234	15	\$2,235

Right-Side Slide Out Storage: 3-Adjustable Shelves, wardrobe compartment with coat/purse hook. Optional Face Lock add MMFL \$78 List. Upgrade to H3S Silver Handle N/C. 20 LEAD TIME

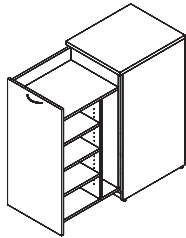

Slide Out Personal Storage Cabinet, Left Door Slide Out Storage (H3B handles)

Model#	Depth	Width	Height	Weight	Cube	Price
MMSDS2442L	24"	20 1/2"	42"	200	12	\$2,085
MMSDS3042L	30"	20 1/2"	42"	234	15	\$2,235

Left-Side Slide Out Storage: 3-Adjustable Shelves, wardrobe compartment with coat/purse hook. Optional Face Lock add MMFL \$78 List. Upgrade to H3S Silver Handle N/C. 20 LEAD TIME

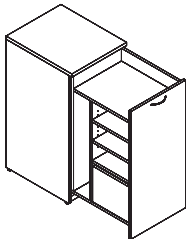

Slide Out Personal Storage Cabinet, Right Door Slide Out File Storage (H3B handles)

Model#	Depth	Width	Height	Weight	Cube	Price
MMSDF2442R	24"	20 1/2"	42"	213	12	\$2,485
MMSDF3042R	30"	20 1/2"	42"	247	15	\$2,635

Right-Side Slide Out Storage: Bottom File Drawer, 2-Adjustable Shelves, wardrobe compartment with coat/purse hook. Optional Face Lock add MMFL \$78 List. Upgrade to H3S Silver Handle N/C. 20 LEAD TIME

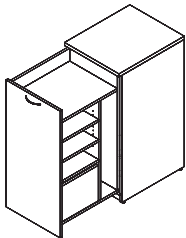

Slide Out Personal Storage Cabinet, Left Door Slide Out File Storage (H3B handles)

Model#	Depth	Width	Height	Weight	Cube	Price
MMSDF2442L	24"	20 1/2"	42"	213	12	\$2,485
MMSDF3042L	30"	20 1/2"	42"	247	15	\$2,635

Left-Side Slide Out Storage: Bottom File Drawer, 2-Adjustable Shelves, wardrobe compartment with coat/purse hook. Optional Face Lock add MMFL \$78 List. Upgrade to H3S Silver Handle N/C. 20 LEAD TIME

Bookcase

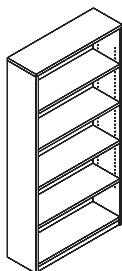

Bookcase (1"-thick adjustable shelves)

Model#	Depth	Width	Height	# Shelves	Weight	Cube	Price
☞ MMBC3630	12"	36"	29"	1	61	18	\$435
☞ MMBC3648	12"	36"	48"	2	86	12	\$586
☞ MMBC3660	12"	36"	60"	3	107	15	\$705
☞ MMBC3665	12"	36"	65"	3	111	17	\$735
☞ MMBC3672	12"	36"	72"	4	128	18	\$764
☞ MMBC3684	12"	36"	84"	5	137	21	\$954

For additional adjustable shelf, add MMSH1 \$113 ea.

maverick series

Files

(All drawers depth are 16"D except vertical files)

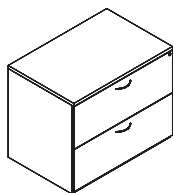

2-drawer Lateral File (H3B handles, lock)

Model#	Depth	Width	Height	Weight	Cube	Price
MMLF2031	20"	31"	29"	135	11	\$910
MMLF2431	24"	31"	29"	147	13	\$936
☞ MMLF202	20"	36"	29"	160	13	\$936
☞ MMLF242	24"	36"	29"	176	15	\$983

Upgrade to H3S Handle N/C. Upgrade to H30 Handle...\$61 each.

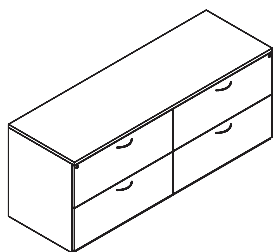

4-Drawer Double Lateral File (H3B handles, 2 locks)

Model#	Depth	Width	Height	Weight	Cube	Price
MMLF202+2	20"	72"	29"	330	25	\$1,950
MMLF242+2	24"	72"	29"	335	30	\$2,033

Upgrade to H3S handles. Upgrade to H30 Handle...\$61 each.

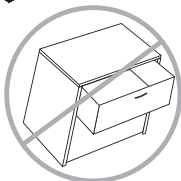

Anti-Tip Interlock Mechanism for 2-Drawer Lateral File or Double Lateral File

Model#	Description	Price
MM UATLF	Adds anti-tip interlock mechanism (Optional)	\$127

4-Drawer Double lateral file requires 2.

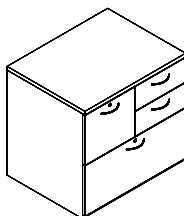

Personal Lateral File 31"W (H3B handles, 2 locks)

Model#	Depth	Width	Height	Weight	Cube	Price
MMPLF20	20"	31"	29"	189	11	\$1,066
MMPLF24	24"	31"	29"	205	13	\$1,117

Upgrade to H3S handles...N/C. Box drawers do not lock. If ordered APH1 handles (1) lock is standard.

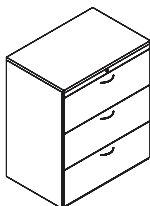

3-drawer Lateral File (H3B handles, lock) Anti-Tip Interlock

Model#	Depth	Width	Height	Weight	Cube	Price
2⓪ MMLF203	20"	36"	43"	240	18	\$1,671
2⓪ MMLF243	24"	36"	43"	264	22	\$1,739

REQUIRES 2⓪ LEAD TIME. Upgrade to H3S handles...N/C. Upgrade to H30 Handle...\$61 each.

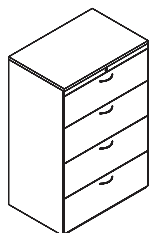

4-drawer Lateral File (H3B handles, lock) Anti-Tip Interlock

Model#	Depth	Width	Height	Weight	Cube	Price
2⓪ MMLF204	20"	36"	55"	330	23	\$2,136
2⓪ MMLF244	24"	36"	55"	335	28	\$2,235

REQUIRES 2⓪ LEAD TIME. Upgrade to H3S handles...N/C. Upgrade to H30 Handle...\$61 each.

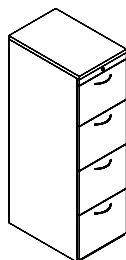

MMVF4

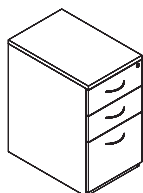

MMVFC

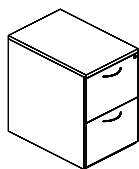

MMVF2

Vertical Files (H3B handles, lock)

Model#	Depth	Width	Height	20"D Drawers	Weight	Cube	Price
☞ MMVF2	24"	16"	29"	2	160	7	\$ 749
☞ MMVFC	24"	16"	29"	3	160	7	\$ 810
MMVF2LGL	24"	19"	29"	2	172	8	\$ 848
2⓪ MMVF4	24"	16"	55"	4	180	7	\$1,570
2⓪ MMVF4LGL	24"	19"	55"	4	190	8	\$1,701

4 Drawer vertical files require 2⓪ LEAD TIME. Upgrade to H3S handles...N/C. Anti-tip interlock is standard on 4-drawer vertical files only.

For handle upgrade, specify from H5-H14, see p. 53 See available accessories and upgrades, pp. 54-56.

maverick series

Pedestals - Freestanding

NOTE: Pedestals below cannot be used for Apex series.
Contact us for quote

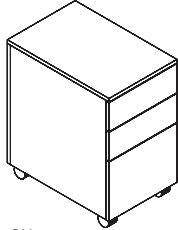

CX

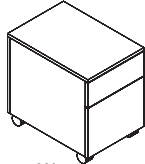

AX

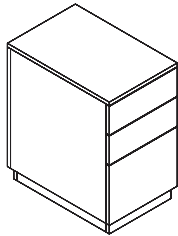

CM

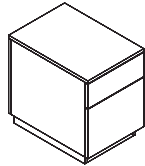

AM

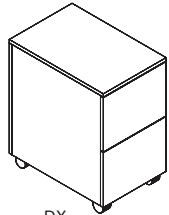

DX

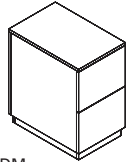

DM

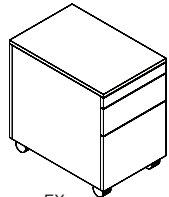

EX

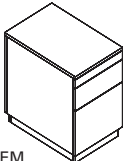

EM

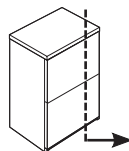

Mobile Pedestal, Box/Box/File or Box/File with Casters (Fully finished, letter size)

Model#	Depth	Width	Height	Drawer Depth	Weight	Cube	Price
MMPED AX	23"	16"	22"	20	56	5	\$628
MMPED AX20	19"	16"	22"	16	56	5	\$615
MMPED CX	23"	16"	27 5/8"	20	90	6	\$749
MMPED CX20	19"	16"	27 5/8"	16	80	6	\$735

Pedestal, Box/Box/File or Box File with Kickbase (Fully finished, letter size, 2 1/2"H kickbase)

Model#	Depth	Width	Height	Drawer Depth	Weight	Cube	Price
MMPED AM	23"	16"	22"	20	50	4	\$628
MMPED AM20	19"	16"	22"	16	50	4	\$615
MMPED CM	23"	16"	27 5/8"	20	90	6	\$749
MMPED CM20	19"	16"	27 5/8"	16	80	6	\$735

1 convenience tray (MM BPT) and 1 file bar is provided.
For handles and ped lock, add MMUHL3...\$88. (Specify H3B-H14, see p. 44). For BF add MMUHL2 \$68
For side pedestal lock only, add MMPL \$78 List. (Specify left or right side lock install) Right side is standard.

Mobile Pedestal, File/File with Casters (Fully finished, letter size)

Model#	Depth	Width	Height	Drawer Depth	Weight	Cube	Price
MMPED DX	23"	16"	27 5/8"	20	90	6	\$735
MMPED DX20	19"	16"	27 5/8"	16	80	6	\$719

Pedestal, File/File with Kickbase (Fully finished, letter size, 2 1/2"H kickbase)

Model#	Depth	Width	Height	Drawer Depth	Weight	Cube	Price
MMPED DM	23"	16"	27 5/8"	20	90	6	\$735
MMPED DM20	19"	16"	27 5/8"	16	80	6	\$719

2 file bars are provided. For handles and ped lock, add MMUHL2...\$68. (Specify H3B-H14, see p. 44).
For side pedestal lock only, add MMPL \$78 List. (Specify left or right side lock install) Right side is standard.

Mobile Pedestal, Pencil/Box/File with Casters (Fully finished, letter size)

Model#	Depth	Width	Height	Drawer Depth	Weight	Cube	Price
MMPED EX	23"	16"	24"	20	90	6	\$749
MMPED EX20	19"	16"	24"	16	80	6	\$735

Pedestal, Pencil/Box/File with Kickbase (Fully finished, letter size, 2 1/2"H kickbase)

Model#	Depth	Width	Height	Drawer Depth	Weight	Cube	Price
MMPED EM	23"	16"	24"	20	90	6	\$749
MMPED EM20	19"	16"	24"	16	80	6	\$735

One file bar provided. For handles and ped lock, add MMUHL3...\$88. (Specify H3B-H14, see p. 44).
For side pedestal lock only, add MMPL \$78 List. (Specify left or right side lock install) Right side is standard.
Pedestal lock locks box file only.

Upgrade Pedestals from Standard Width to Legal Width

Model#	Depth	Width	Height	Weight	Cube	Price
MM UPEDLGL	no change	19"	no change	128	8	\$99

Depth and height does not change. Option to upgrade is available for all pedestals above.

See available accessories and upgrades, pp. 53-56.

maverick series

Upgrades and Accessories for Hutches

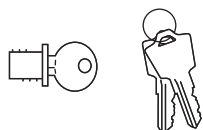
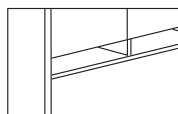
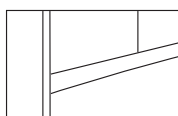
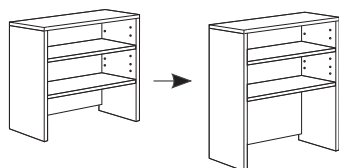
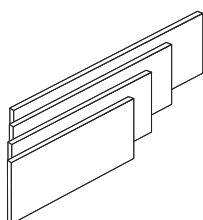
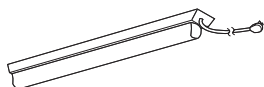
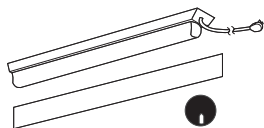

Tasklight, Fascia & Grommet (One black light, hutch with fascia and one grommet on back panel)

Model#	Depth	Width	Height	Weight	Cube	Price
MM TSKLT2	7/8"	24 1/2"	1 7/8"	2	.1	\$397

Fascia is sized to fit the hutch size specified. Grommet is placed on back of hutch just below the shelf. 72" width hutch takes 2 lights. Use MMTSKLTX pricing (below) for additional light, LED light.

Tasklight, Black (One additional tasklight)

Model#	Depth	Width	Height	Weight	Cube	Price
MM TSKLTX	7/8"	24 1/2"	1 7/8"	2	.1	\$192 ea.

Lights interconnect to other lights, can link up to 6 units max, LED light.

Hutch Tackboards

Model#	Depth	Width	Height	Hutch Width	Weight	Cube	Price
MM TKBD30	1"	28"	14 1/4"	36"	9	.5	\$389
MM TKBD36	1"	34"	14 1/4"	42"	9	.5	\$405
MM TKBD42	1"	40"	14 1/4"	48"	12	.6	\$418
MM TKBD48	1"	46"	14 1/4"	54"	12	.6	\$450
MM TKBD54	1"	52"	14 1/4"	60"	15	.7	\$480
MM TKBD60	1"	58"	14 1/4"	66"	17	.8	\$509
MM TKBD66	1"	64"	14 1/4"	72"	19	1	\$545
MM TKBD72	1"	70"	14 1/4"	78"	21	1	\$665
MM TKBD78 (2 pcs)	1"	76"	14 1/4"	84"	23	1	\$740

For COM fabric add \$30/Sq. yd. Required yardage to be provided by customer.
78" width is made in 2 pieces.
For fabric color choice, see inside back cover. For Underground Fabric add 25%

Fabric Chart (Uses Guilford of Maine)

STANDARD FABRICS

Tempest 2120...Zebra 015, Silk 045 **Sprite 2671...**Snow 7040, Linen 7010

Anchorage 2335...Sunshine 2082, Waterfall 2691, Green Apple 2087, Aubergine 2036, Goose 2049, Onyx 2016, Red Delicious 2014

Metro 3077...Storefront 030, Skyscraper 022 **Cape Cod 3073...**Linen 7031, Surf 7062

Metalation 5118...Chrome 1676, Polished Pewter 1678

Cadence 5595...Jade 1441, Turquoise 1442, Opal 1432, Sapphire 1443, Coral 1437

25% UPCHARGE*

* **Underground 2967...**Champagne 010, Tangerine 070, Azure 050, Ocean 041, Pepper 030, Earth 061

Upgrade Hutch Height from 36"H to 42"H

Model#	Price
MM UHH	\$176

Hutches: Doors or shelves do not change, bottom clearance increases by 6".
Bookcase hutch: 12"H bottom clearance does not change.

Hutch Fascia/Valance (Decreases clearance under shelf by 2")

Model#	Depth	Width	Height	Weight	Cube	Price
MM VAL	3/4"	varies	2"	varies	varies	\$135

Hutch Mail Slots (Paper manager) (Decreases clearance under shelf by 5")

Model#	Depth	Width	Height	Weight	Cube	Price
MM HMS	12"	varies	4 3/4"	varies	varies	\$227

Face Lock for Hutch Doors

Model#	Depth	Width	Height	Weight	Cube	Price
MM FL						\$78

1 per set of 2 doors. Hutch with 4 doors takes 2 locks. Glass doors do NOT lock.

maverick series

Upgrades and Accessories

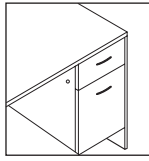

Package Upgrade (Includes 2 handles and 1 lock) for Box/File or File/File Pedestals

Model#	Price
MM UHL2	\$68

Specify package handle option H3B-H10 & H14. See below.

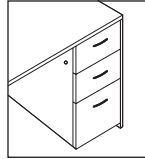

Package Upgrade (Includes 3 handles and 1 lock) for Box/Box/File Pedestal

Model#	Price
MM UHL3	\$88

Specify package handle option H3B-H10 & H14. See below.

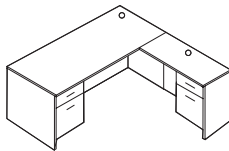

**Package Upgrade, For "L" Shape Box/File Ped Units
(Includes 2 grommets, 4 handles & 2 locks)**

Model#	Price
MM UGL	\$182

Grommets standard locations as shown. Specify package handle option H3B-H10 & H14. See below.

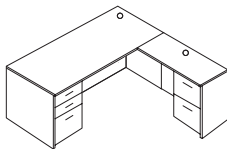

**Package Upgrade, For "L" Shape Box/Box/File, File/File Ped Units
(Includes 2 grommets, 5 handles & 2 locks)**

Model#	Price
MM UGLFP	\$213

Grommets standard locations as shown. Specify package handle option H3B-H10 & H14. See below.

NOTE: Lock numbers are randomly assigned, key alike must be specify. No charge.

HANDLE OPTIONS FOR PACKAGES UHL2, UHL3, UGL & UGLFP



Crescent Black
(MM H3B)



Crescent Silver
(MM H3S)



Elliptical Black
(MM H5B)



Elliptical Silver
(MM H5S)



Crescent Textured Nickel
(MM H6)



Flared Nickel
(MM H7)



Bow Handle
(MM H8)



Curved Handle
(MM H9)



Bar Square Handle
(MM H10)



Bar Handle
(MM H14)

maverick series

Upgrades and Accessories

GROMMETS

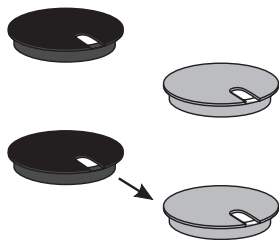

Grommet (Plastic cover, hole in surface, each)

Model#	Color	Depth	Width	Surface Hole Diameter	Price
MM GR234B	Black Plastic	3"	3"	2 3/4"	\$49
MM GR234S	Silver Plastic	3"	3"	2 3/4"	\$49

Specify grommet location.

Grommet Color Upgrade, from Standard Black to Silver

Model#	Color	Depth	Width	Surface Hole Diameter	Price
MM UGR234S	Silver Plastic	3"	3"	2 3/4"	N/C

Upgrade grommet color on items that are shown with standard grommets (i.e. MMCD72 4R)

GROMMETS LOCATION (WORKSURFACE)

NOTE: While sitting at unit, grommet locations named from left to right.
 For grommet location on tops and/or modesty panel specify left, center or right.
 No grommets over pedestals.

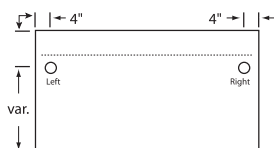

Desks

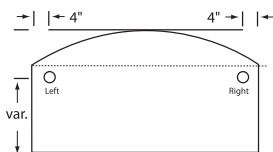

Desks

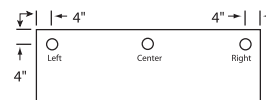

Credenza, Return, Bridges

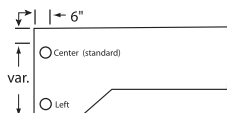

CompuCredenza

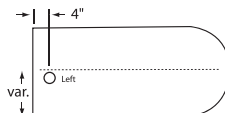

Bullets

maverick series

Statement of Line

RECEPTION



Reception - Single Ped
Single ped, desk only transaction
(RCAS)

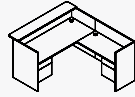

Reception - "L" Shape
Desk transaction counter only
(RCAX)

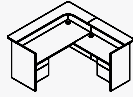

Reception - "L" Shape
Transaction counter on desk & return
(RCAL)

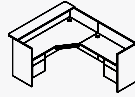

Reception - "L" Shape Computer
Desk transaction counter only
(RCDX)

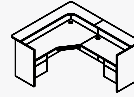

Reception - "L" Shape Computer
Transaction counter on desk & return
(RCDL)

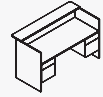

Reception - Double Ped
Desk transaction Counter
(RCAD)

NOTES:

- Before ordering, ensure that the building and room access, including elevators, will accommodate furniture of this size. Use of pin-and-cam construction does facilitate some disassembly.
- Details of front transaction counter vary by series as do pedestals.
- Handles and locks standards vary by series.

How to Order Reception Units

WORKSURFACE UNITS: RECEPTION UNITS

1. Product number: **MM RCAL 36 72 L**

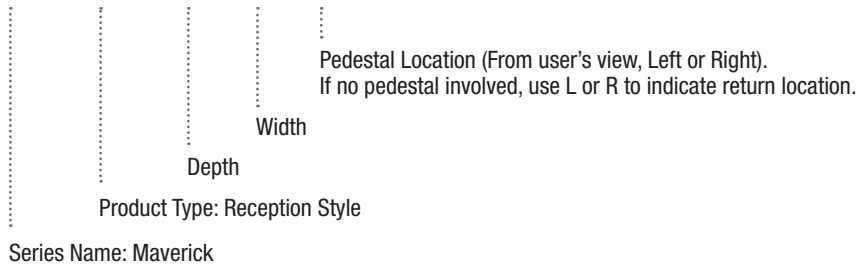

2. Specify worksurface finish. See back cover.
3. Specify worksurface edge trim finish. Matching color edge is standard. See back cover.
4. Specify chassis finish. Matching color edge trim is standard. See back cover.
5. Handles and lock options. See page 52 for prices.
6. Specify other accessories and upgrade options. See page 52-57.

HANDLE OPTIONS



Crescent Black
(MM H3B)



Crescent Silver
(MM H3S)



Elliptical Black
(MM H5B)



Elliptical Silver
(MM H5S)



Crescent Textured Nickel
(MM H6)



Flared Nickel
(MM H7)



Bow Handle
(MM H8)



Curved Handle
(MM H9)



Bar Square Handle
(MM H10)



Bar Handle
(MM H14)

IMPORTANT NOTE: Individual handles, see page 53 for options and prices.



GROMMET

Black grommet standard where shown. Upgrade to silver color, N/C.

maverick series

Risers for Desks and Returns

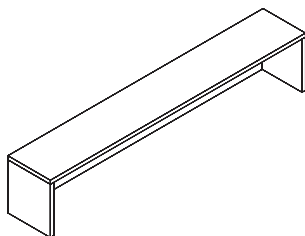

Riser (No approach overhang)

Model#	Depth	Width	Height	Weight	Cube	Price
MMRB36	12"	36"	14"	38	1	\$356
MMRB42	12"	42"	14"	43	2	\$371
MMRB48	12"	48"	14"	47	5	\$400
MMRB60	12"	60"	14"	56	6	\$574
MMRB66	12"	66"	14"	61	7	\$650
MMRB72	12"	72"	14"	65	7	\$725

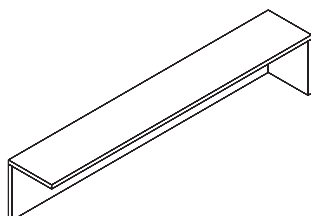

Riser Return, Right (No approach overhang)

Model#	Depth	Width	Height	Weight	Cube	Price
MMRBR36R	12"	36"	14"	32	1	\$356
MMRBR42R	12"	42"	14"	37	2	\$371
MMRBR48R	12"	48"	14"	42	5	\$400
MMRBR54R	12"	54"	14"	47	6	\$485
MMRBR60R	12"	60"	14"	51	6	\$574
MMRBR66R	12"	66"	14"	56	7	\$650
MMRBR72R	12"	72"	14"	60	7	\$725

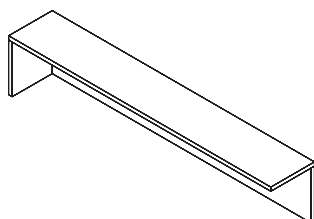

Riser Return, Left (No approach overhang)

Model#	Depth	Width	Height	Weight	Cube	Price
MMRBR36L	12"	36"	14"	32	1	\$356
MMRBR42L	12"	42"	14"	37	2	\$371
MMRBR48L	12"	48"	14"	42	5	\$400
MMRBR54L	12"	54"	14"	47	6	\$485
MMRBR60L	12"	60"	14"	51	6	\$574
MMRBR66L	12"	66"	14"	56	7	\$650
MMRBR72L	12"	72"	14"	60	7	\$725

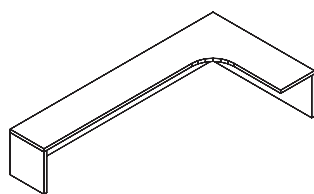

Riser "L" Shape, Right Return (12" deep, one-piece counter top)

Model#	Depth	Width	Height	Weight	Cube	Price
MMRBL3072R	30"	72"	14"	88	18	\$ 931
MMRBL3672R	36"	72"	14"	92	21	\$1,060

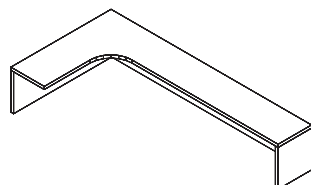

Riser "L" Shape, Left Return (12" deep, one-piece counter top)

Model#	Depth	Width	Height	Weight	Cube	Price
MMRBL3072L	30"	72"	14"	88	18	\$ 931
MMRBL3672L	36"	72"	14"	92	21	\$1,060

Notes on standard woodgrain directions:

- The front on the bridge or return unit will display the woodgrain running horizontally for 66" or larger
- On other vertical surfaces, the woodgrain runs vertically
- Worksurface woodgrain on bridge for desk runs left-to-right
- The return countertop grain direction coordinates with the desk surface, running from user's side-to-approach side except on 66" to 72" returns

maverick series

Risers, Desks and Returns

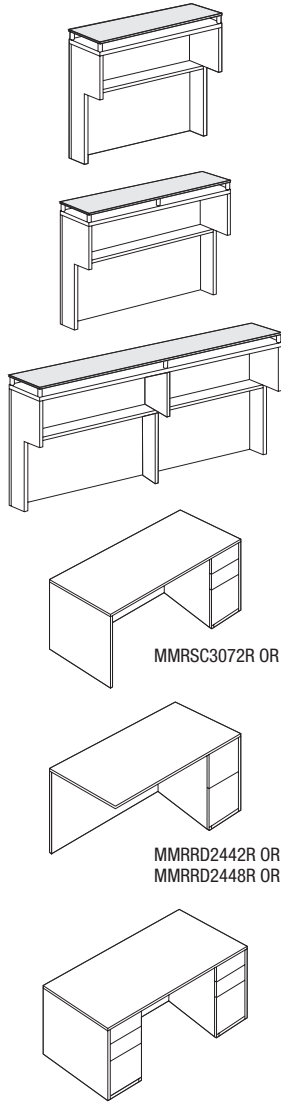

MMRSC3072R OR L

MMRRD2442R OR L
MMRRD2448R OR L

Riser (Clear glass counter top, 4 aluminum spacers)

Model#	Depth	Width	Height	Weight	Cube	Price
MMRB3632G	12"	36"	32"	89	16	\$1,484

Riser (Clear glass counter top, 6 aluminum spacers)

Model#	Depth	Width	Height	Weight	Cube	Price
MMRB4832G	12"	48"	32"	89	17	\$1,694

Riser (Clear glass counter top, center leg support, 6 aluminum spacers)

Model#	Depth	Width	Height	Weight	Cube	Price
MMRB6032G	12"	60"	32"	92	20	\$2,117
MMRB7232G	12"	72"	32"	124	24	\$2,528

Single Pedestal Desk Flush Full Modesty Panel, Box/Box/File (Specify left or right)

Model#	Depth	Width	Height	Weight	Cube	Price
MMRSC3060R	30"	60"	29"	224	32	\$1,477
MMRSC3060L	30"	60"	29"	224	32	\$1,477
MMRSC3072R	30"	72"	29"	267	45	\$1,596
MMRSC3072L	30"	72"	29"	267	45	\$1,596

Return Full Modesty Panel, File/File (Specify left or right)

Model#	Depth	Width	Height	Weight	Cube	Price
MMRRD2442R	24"	42"	29"	107	18	\$1,399
MMRRD2442L	24"	42"	29"	107	18	\$1,399
MMRRD2448R	24"	48"	29"	114	20	\$1,429
MMRRD2448L	24"	48"	29"	114	20	\$1,429

Double Pedestal Desk, Flush Full Modesty Panel, Left and Right Box/Box/File

Model#	Depth	Width	Height	Weight	Cube	Price
MMRDC3072	30"	72"	29"	314	38	\$2,039
MMRDC3672	36"	72"	29"	337	45	\$2,054

Notes for risers, desks and returns:

- Desks & Returns are designed (pin & cam) to accept risers. Risers add 6" to overall depth
- Can be placed on desks of same width or longer width as desired
- For longer width desks: Must specify riser placement left or right side of desk
- Flush modesty panel on desk. Pedestals on desks and returns are full to floor
- **REQUIRES 4-WEEK LEAD TIME**
- For handles & pedestal locks add MMUHL3...\$88 each ped. MMUHL2...\$68 each ped, see page 52

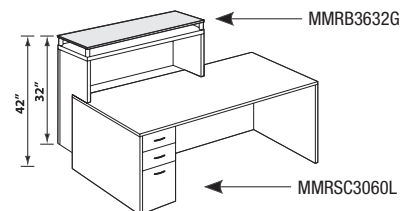
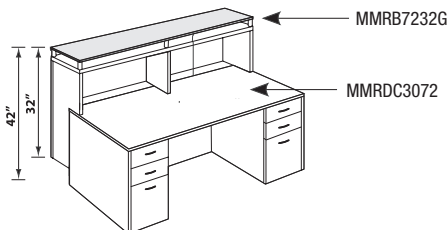
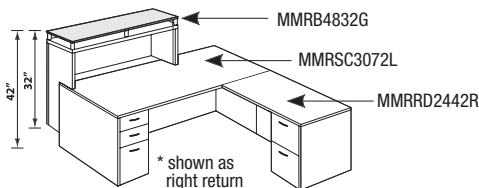
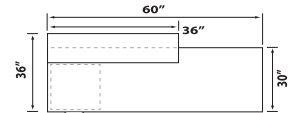
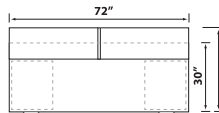
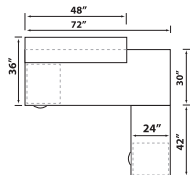

NOTE: Risers are designed for the style of desks and returns on this page

See available accessories and upgrades, pp. 53-56.

maverick series

Reception Units - L-Shapes (Desk and Return with Transaction Counters)

NOTE: Before ordering, ensure that the building and room access, including elevators, will accommodate furniture of this size. Use of pin-and-cam construction does facilitate some reassembly. Upgrade to full pedestals, See page 52. For handles and pedestal lock packages, see page 52.

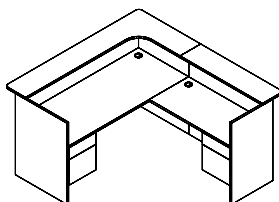

Reception "L" Unit, Solid One-Piece Front, Right Return 24" x 48" (2 Grommets)

Model#	Depth	Width	Height	Weight	Cube	Price
MMRCAL3060R*	72"	66"	42"	400	92	\$3,036
MMRCAL3072R	84"	78"	42"	435	104	\$3,256
MMRCAL3672R	90"	78"	42"	439	115	\$3,382
MMRCAL3684R	90"	90"	42"	522	127	\$3,674

Counter top is 12" deep. Counter top approach overhang is 6". Worksurface black grommets standard. Fan top on approach side of desk counter may be specified at no upcharge, insert F before C (e.g. MMRFCAL3060R) Transaction counter to desktop clearance is 11 3/4". Upgrade grommet cover to silver, N/C.
*MMRCAL3060R comes with a 20" x 36" right return.

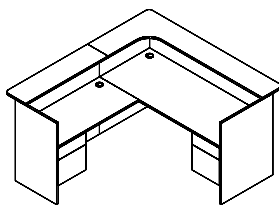

Reception "L" Unit, Solid One-Piece Front, Left Return 24" x 48" (2 Grommets)

Model#	Depth	Width	Height	Weight	Cube	Price
MMRCAL3060L*	72"	66"	42"	400	92	\$3,036
MMRCAL3072L	84"	78"	42"	435	104	\$3,256
MMRCAL3672L	90"	78"	42"	439	115	\$3,382
MMRCAL3684L	90"	90"	42"	522	127	\$3,674

Counter top is 12" deep. Counter top approach overhang is 6". Worksurface black grommets standard. Fan top on approach side of desk counter may be specified at no upcharge, insert F before C (e.g. MMRFCAL3060L) Transaction counter to desktop clearance is 11 3/4". Upgrade grommet cover to silver, N/C.
*MMRCAL3060L comes with a 20" x 36" left return.

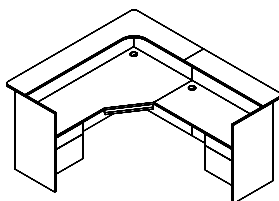

Computer Reception "L" Unit, Solid One-Piece Front, Right Return 24" x 48" (2 Grommets)

Model#	Depth	Width	Height	Weight	Cube	Price
MMRCDL3672R	90"	78"	42"	435	88	\$3,382

Counter top is 12" deep. Counter top approach overhang is 6". Worksurface black grommets and keyboard tray standard. Fan top to approach side of desk counter may be specified at no upcharge, insert F before C (e.g. MMRFCDL3672R) Transaction counter to desktop clearance is 11 3/4". Upgrade grommet cover to silver, N/C.

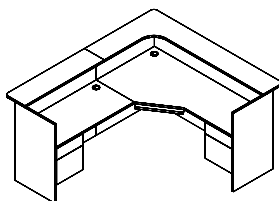

Computer Reception "L" Unit, Solid One-Piece Front, Left Return 24" x 48" (2 Grommets)

Model#	Depth	Width	Height	Weight	Cube	Price
MMRCDL3672L	90"	78"	42"	435	88	\$3,382

Counter top is 12" deep. Counter top approach overhang is 6". Worksurface black grommets and keyboard tray standard. Fan top to approach side of desk counter may be specified at no upcharge, insert F before C (e.g. MMRFCDL3672L) Transaction counter to desktop clearance is 11 3/4". Upgrade grommet cover to silver, N/C.

Notes on standard woodgrain directions:

- The one-piece vertical front on the desk of the unit will display the woodgrain running horizontally (except 60")
- On other vertical surfaces, the woodgrain runs vertically
- Worksurface woodgrain on desk runs left-to-right
- The return worksurface grain direction coordinates with the desk surface, running from user's side to the approach side
- Transaction counter woodgrain runs the same direction as the worksurface woodgrain

maverick series

Reception Units - L-Shapes and Reception Desks (Desk-Only Transaction Counter)

NOTE: Before ordering, ensure that the building and room access, including elevators, will accommodate furniture of this size. Use of pin-and-cam construction does facilitate some reassembly. Upgrade to full pedestals, See below. For handles and pedestal lock packages, see page 52.

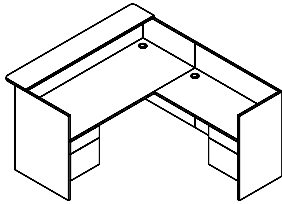

Reception "L" Unit, Solid One-Piece Front, Right Return 24" x 48"
(Desk counter only) 2 Grommet

Model#	Depth	Width	Height	Weight	Cube	Price
MMRCAX3060R*	72"	60"	42"	390	92	\$2,843
MMRCAX3072R	84"	72"	42"	425	92	\$3,014
MMRCAX3672R	90"	72"	42"	430	92	\$3,337

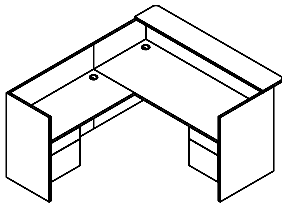

Reception "L" Unit, Solid One-Piece Front, Left Return 24" x 48"
(Desk counter only) 2 Grommet

Model#	Depth	Width	Height	Weight	Cube	Price
MMRCAX3060L*	72"	60"	42"	390	92	\$2,843
MMRCAX3072L	84"	72"	42"	425	92	\$3,014
MMRCAX3672L	90"	72"	42"	430	92	\$3,337

Counter top is 12" deep. Counter top approach overhang is 6". Worksurface black grommets standard. Fan top on approach side of desk counter may be specified at no upcharge, insert F before C (e.g. MMRFCAX3060R) Transaction counter to desktop clearance is 11 3/4". *MMRCAX3060 comes with a 20"x 36" return. Upgrade grommet cover to silver, N/C.

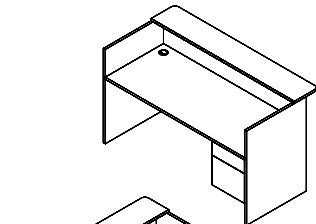

Reception Single Pedestal Desk, BF Right (Desk counter only) Left Grommet

Model#	Depth	Width	Height	Weight	Cube	Price
MMRCAS3060R	36"	60"	42"	232	53	\$1,870
MMRCAS3072R	36"	72"	42"	250	63	\$1,957

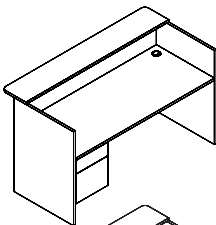

Reception Single Pedestal Desk, BF Left (Desk counter only) Right Grommet

Model#	Depth	Width	Height	Weight	Cube	Price
MMRCAS3060L	36"	60"	42"	232	53	\$1,870
MMRCAS3072L	36"	72"	42"	250	63	\$1,957

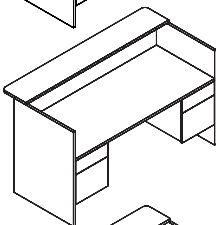

Reception Double Pedestal Desk, Left & Right BF (Desk counter only) No Grommet

Model#	Depth	Width	Height	Weight	Cube	Price
MMRCAD3072	36"	72"	42"	250	63	\$2,270

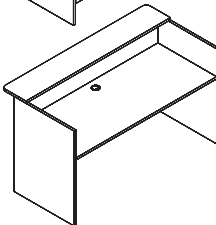

Reception Desk Shell (Desk counter only) Center Grommet

Model#	Depth	Width	Height	Weight	Cube	Price
MMRCAN3060	36"	60"	42"	186	53	\$1,525
MMRCAN3072	36"	72"	42"	210	63	\$1,610

Counter top is 12" deep. Counter top approach overhang is 6". Worksurface black grommets standard. Fan top on approach side of desk counter may be specified at no upcharge, insert F before C (e.g. MMRFCAS3060R) Transaction counter to desktop clearance is 11 3/4". Upgrade grommet cover to silver, N/C.

Notes on standard woodgrain directions:

- The one-piece vertical front on the desk of the unit will display the woodgrain running horizontally (except 60")
- On other vertical surfaces, the woodgrain runs vertically
- Worksurface woodgrain on desk runs left-to-right
- The return worksurface grain direction coordinates with the desk surface, running from user's side to the approach side
- Transaction counter woodgrain runs the same direction as the worksurface woodgrain

See available accessories and upgrades, pp. 53-56.

maverick series

Reception Units - Computer L-Shapes Desks and Return (Desk-Only Transaction Counter)

NOTE: Before ordering, ensure that the building and room access, including elevators, will accommodate furniture of this size. Use of pin-and-cam construction does facilitate some reassembly. Upgrade to full pedestals, See below. For handles and pedestal lock packages, see page 52.

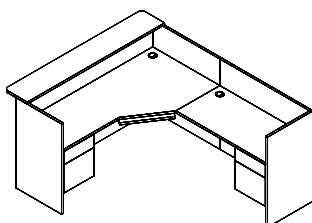

Computer Reception "L" Unit, Solid One-Piece Front, Right Return 24" x 48"
(Desk counter only) 2 Grommet

Model#	Depth	Width	Height	Weight	Cube	Price
MMRCDX3672R	90"	72"	42"	425	88	\$3,014

Counter top is 12" deep. Counter top approach overhang is 6". Worksurface black grommets and keyboard tray standard. Fan top on approach side of desk counter may be specified at no upcharge, insert F before C (e.g. MMRFCDX3672R) Desk counter only.
Transaction counter-to-desktop clearance is 11 3/4". Upgrade grommet cover to silver, N/C.

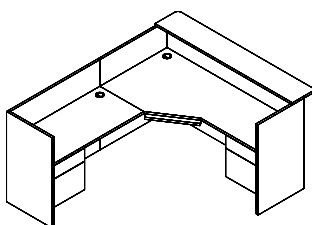

Computer Reception "L" Unit, Solid One-Piece Front, Left Return 24" x 48"
(Desk counter only) 2 Grommet

Model#	Depth	Width	Height	Weight	Cube	Price
MMRCDX3672L	90"	72"	42"	425	88	\$3,014

Counter top is 12" deep. Counter top approach overhang is 6". Worksurface black grommets and keyboard tray standard. Fan top on approach side of desk counter may be specified at no upcharge, insert F before C (e.g. MMRFCDX3672L) Desk counter only.
Transaction counter-to-desktop clearance is 11 3/4". Upgrade grommet cover to silver, N/C.

Reception Units Pedestal Upgrade

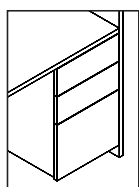

MMUPEDC

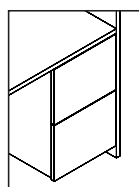

MMUPEDD

Upgrade to Full Pedestals (Pedestal upgrade for receptions only)

Model#	Depth	Width	Height	Weight	Cube	Price
MMUPEDC	19"	15 3/4"	25 3/16"	75	6	\$244 ea.
	(Upgrade from BF to BBF)					
MMUPEDD	19"	15 3/4"	25 3/16"	75	6	\$215 ea.
	(Upgrade from BF to FF)					

Notes on standard woodgrain directions:

- The one-piece vertical front on the desk of the unit will display the woodgrain running horizontally (except 60")
- On other vertical surfaces, the woodgrain runs vertically
- Worksurface woodgrain on desk runs left-to-right
- The return worksurface grain direction coordinates with the desk surface, running from user's side to the approach side
- Transaction counter woodgrain runs the same direction as the worksurface woodgrain

maverick series

Upgrades and Accessories for Reception Units

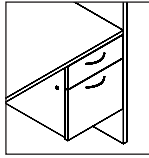

Package Upgrade (Includes 2 handles and 1 lock) for Box/File or File/File Pedestals

Model#	Price
MM UHL2	\$68

Specify package handle option H3B-H10 & H14. See below.

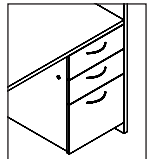

Package Upgrade (Includes 3 handles and 1 lock) for Box/Box/File Pedestal

Model#	Price
MM UHL3	\$88

Specify package handle option H3B-H10 & H14. See below.

NOTE: Lock numbers are randomly assigned, key alike must be specify. No charge.

HANDLE OPTIONS FOR PACKAGES UHL2, UHL3



Crescent Black
(MM H3B)



Crescent Silver
(MM H3S)



Elliptical Black
(MM H5B)



Elliptical Silver
(MM H5S)



Crescent Textured Nickel
(MM H6)



Flared Nickel
(MM H7)



Bow Handle
(MM H8)



Curved Handle
(MM H9)



Bar Square Handle
(MM H10)



Bar Handle
(MM H14)

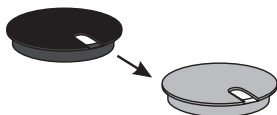

Upgrade Grommet Color from Standard Black to Silver

Model#	Color	Depth	Width	Surface Hole Diameter	Price
MM UGR234S	Silver Plastic	3"	3"	2 3/4"	N/C

For receptions.

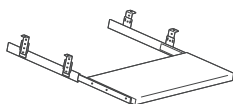

Keyboard Tray, Rollout (Specify laminate color)

Model#	Depth	Width	Height	Weight	Cube	Price
MM KB	16"	21"	3"	10	.5	\$135

Optional.

maverick series

Accessories

H3B handle is standard only on Maverick Series storage units and lateral files, option to upgrade handles: H3S no charge. H5 - H10 and H14 add \$14 each.



Crescent Handle, Metal - Black or Silver Finish

Model#	Hole Center	Width	Color	Price
☞ MM H3B	5"	5 3/4"	Black	\$28/ea.
☞ MM H3S	5"	5 3/4"	Silver	\$28/ea.

Elliptical Handle, Metal - Black or Silver Finish

Model#	Hole Center	Width	Color	Price
☞ MM H5B	5"	6 3/4"	Black	\$28/ea.
☞ MM H5S	5"	6 3/4"	Silver	\$28/ea.

Crescent Textured Nickel Handle, Metal - Silver Finish

Model#	Hole Center	Width	Price
☞ MM H6	5"	6 1/4"	\$28/ea.

Flared Nickel Handle, Metal - Silver Finish

Model#	Hole Center	Width	Price
☞ MM H7	5"	6 1/4"	\$28/ea.

Bow Handle, Silver Finish

Model#	Hole Center	Width	Price
☞ MM H8	5"	6 1/8"	\$28/ea.

Curved Handle, Silver Finish

Model#	Hole Center	Width	Price
☞ MM H9	5"	6 1/2"	\$28/ea.

Bar Square Handle, Silver Finish

Model#	Hole Center	Width	Price
☞ MM H10	5"	5 3/8"	\$28/ea.
MM H11	11"	11 3/8"	\$61/ea.

MM H11 handles are not available for package choices, full upgrade charges apply.

Bar Handle, Silver Finish

Model#	Hole Center	Width	Price
☞ MM H14	11"	14"	\$28/ea.
MM H30*	27"	30"	\$61/ea.

MM H30* handles DO NOT fit on pedestal drawers or hutch doors. Full upgrade charges apply for MM H30.

Curved Edge Apex Handle, Brushed Aluminum Finish

Model#	Hole Center	Width	Price
APH1	1 5/8"	7 7/8"	\$55/ea.

Not available for package choice. Extends ☞ lead time. Full upgrade charges apply.
When ordering APH1 handles for personal lateral files (1) lock is standard, locks file and lateral file drawer.

maverick series

Accessories and Upgrades

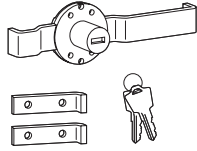

Pedestal Lock (Mounted on side of pedestal)

Model#	Description	Price
MM PL	Side pedestal lock	\$78

For **freestanding pedestals**, specify left or right side pedestal lock installation. Lock numbers are randomly assigned, key alike must be specify. No charge.

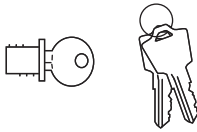

Face Lock

Model#	Description	Price
MM FL	Face lock for TFM doors or center drawers	\$78
MM FFL	Full face lock for pedestals	\$156

MMFL: 1 per set of 2 doors. Hutch with 4 doors requires 2 locks.
MMFLL: For B/F, F/F & BBF Pedestals.
Lock numbers are randomly assigned, key alike must be specify. No charge.

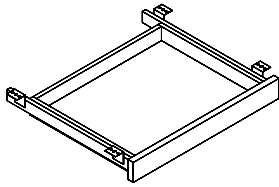

Center Drawer (9-ply birch wood drawer interior, specify front laminate color)

Model#	Depth	Width	Height	Weight	Cube	Price
MM CD	16"	21"	2 1/2"	12	.5	\$148



Box Drawer Convenience Tray, Black (Insets to box drawer)

Model#	Depth	Width	Height	Weight	Cube	Price
MM BPT	5 1/2"	12"	1"	1	.5	\$28

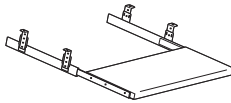

Keyboard Tray, Rollout (Specify laminate color)

Model#	Depth	Width	Height	Weight	Cube	Price
MM KB	16"	21"	3"	10	.5	\$135

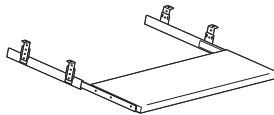

Oversize Keyboard Tray, Rollout (Specify laminate color)

Model#	Depth	Width	Height	Weight	Cube	Price
MM KBLG	16"	28"	3"	12	.5	\$199

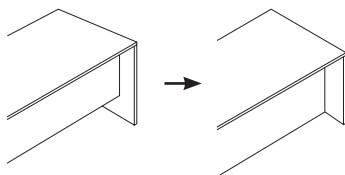

Full Modesty Panel Upgrade (From 3/4" modesty panel)

Model#	Depth	Width	Height	Weight	Cube	Price
MM FMP	3/4"	varies	28"	varies	varies	\$64

Option to upgrade from 3/4" modesty panel to full modesty panel.

maverick series

Accessories and Upgrades

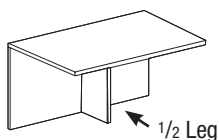

Half-Leg Support with Leveler (Add to long pieces for support)

Model#	Depth	Width	Height	Weight	Cube	Price
MM SPT	12"	1"	28"	11	3	\$113

Support leg can also be used to create freestanding returns. Specify location left or right 1/2 leg.

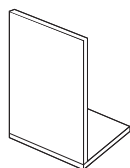

CPU Section, CPU1 for 3/4 Height Ped, CPU2 for Full Height Ped

Model#	Depth	Width	Height	Weight	Cube	Price
MM CPU1	16"	10"	18 3/4"	15	2	\$113
MM CPU2	16"	10"	27 5/8"	18	3	\$142

Specify left or right mount. Add to desk, return or credenza.

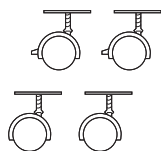

Casters, Set of Four (Two locking, two non-locking. For stands & HDC only)

Model#	Height	Price
MM CAS	2 1/2"	\$99

Height increases by 2 1/2" H.

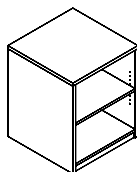

Printer Stand (Adjustable shelf, two back openings)

Model#	Depth	Width	Height	Weight	Cube	Price
MM PS2424	24"	24"	29"	65	10	\$579

For casters, add MMCAS \$99. Increases Height by 2 1/2" H.

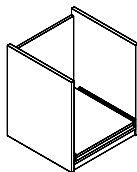

Printer Shelf with Roll-Out Shelf (Add to desk, return or credenza, each)

Model#	Depth	Width	Height	Weight	Cube	Price
MM PSS	22"	24"	28"	53	10	\$375

Rollout shelf is installed 1" clear from bottom.

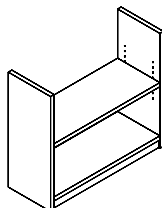

Bookcase Section (One adjustable shelf. Add to bridge or return shelf)

Model#	Depth	Width	Height	Weight	Cube	Price
MM BCS	12"	32"	28"	varies	varies	\$261

No back panel.

maverick series

Accessories and Upgrades



Additional Adjustable Shelf for Bookcases (1"-thick standard, with shelf pins)

Model#	Depth	Width	Height	Weight	Cube	Price
MM SH1	11 1/16"	33 3/4"	1"	13	.5	\$113

Fits standard bookcases. Includes 4-pins per shelf.

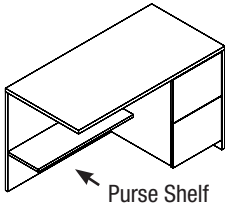

Purse Shelf (Add to desk, return or credenza)

Model#	Depth	Width	Height	Weight	Cube	Price
MM PS	10"	varies	3/4"	varies	varies	\$113

Installed 17"H below top.

Cut Charges

Standard Cuts and Reprogramming Charges (Extends lead time)

Model#	Maverick Series Only	Price
MM CUT1	Height or Width or Depth, 90° Cut on 90° Pieces	\$ 99
MM CUT2	Two Dimensions, 90° Cuts on 90° Pieces	\$155
MM CUT3	Programming Charge	\$155

For Maverick Series items cut charges only.

High Pressure Laminate

HPL Tops, with Standard Color 2MM Edge Band (Maverick standard colors only. Extends lead time)

Model#	Standard Maverick Colors	Price
MM HPLM	Matte High Pressure Laminate Top Only, 2MM Edge Band	15%
MM HPLG	Gloss High Pressure Laminate Top Only, 2MM Edge Band	25%

For custom HPL color laminates, please submit quote.
Maverick does not guarantee delamination from sun exposure.

Carton

Cartoning Charges (Extends lead time)

Model#	Price	
MM CAR4	Pallet Cartoning (Corner & edge protectors w/bubble/shrink wrap, place in carton, strap to pallet)	25%

maverick complete



Maverick Complete, our most popular and complete series with the ability to mix and match any of our standard colors, provides modern day durability for any office space.

Features

Maverick Complete Series is standard with full modesty panel, full pedestals to floor, locking, handles. Hutch with fascia, grommets on credenzas, bridges and returns.

Edge Profile



Side View



Product Specifications

Colors

- All 20 standard colors are available on tops and chassis

Top / Worksurfaces

- 1" TFM (Thermally Fused Melamine) on industrial quality (45 lb.) particleboard
- 2 mm thermally-fused PVC edge banding
- Conference table tops present a 1¾" built-up edge
- Metal-to-metal connection fittings are installed for bridges and returns
- Woodgrain direction on tops of bridges and returns runs from user side to approach side to coordinate with main unit tops

Chassis Construction

- TFM chassis fastened by screws, steel brackets, and/or concealed fasteners
- 1"-thick end panels on desks, returns, credenzas, and bookcases. ¾" thick end panels on hutches
- Full-height modesty panel is standard on all desks, credenzas, bridges & returns; 12" modesty may be specified at no upcharge on bridges and returns. Full pedestal to floor is standard.
- Bullet desks are standard with full modesty panel and have 4" black metal posts
- Conference tables, see conference section for Maverick series (MM)
- Unless otherwise specified, conference and round table bases are the same color as the top. Contrasting colors may be specified at no charge
- The modesty inset on the approach side for 30"-deep tops is 6"; for 36"-deep tops, inset is 12"
- The modesty panel is flush to the approach edge on 20"-and 24"-deep tops
- Visible edges are edged with 2 mm thermally-fused PVC edge banding
- Adjustable leveling glides are provided on all units that are designed to be set on the floor
- Hutches for Maverick Complete are designed to fit Maverick Complete ONLY.
- Product heights are coordinated to facilitate matching, e.g., credenza plus hutch is 65" high. Optional 72" height is available, see page 97 for height upgrade
- Standard woodgrain direction on the modesty of pieces 60" wide or less is vertical. On pieces wider than 60", the grain direction is horizontal
- Lateral file and vertical file chassis are all ¾" material

Drawer Interiors

- 9-ply Birch wood drawers

Drawer Suspension, Construction and Doors

- Box drawers have full-extension, progressive-action slides with precision steel ball bearings
- Heavy-duty file rods in file drawers
- Handles and locks are standard on all pedestals, lateral files, face lock on freestanding pedestals and storage cabinets
- All units have MMH3B handles standard
- Overlay drawer front and doors are standard on all separate storage units and separate file units. Other furniture with storage and lateral file elements are inset to the end panels of chassis and overlay at the kneespace
- All file and lateral drawers file legal-size from side-to-side
- Each desk only is provided with one box drawer convenience tray. See page 106 for optional additional trays for other units
- File drawer construction accommodates hanging files not stacked material on drawer bottom
- Hutch doors overlay sides before inset to top with 19" clearance below

Cord Management

- Centered grommets in the worksurface and modesty are standard on bridges, credenzas and returns; ¾" clearance at bottom of hutch backs
- Optional grommets on page 98

Locks

- Locks are standard on all pedestals, lateral files, freestanding pedestals and tower storage
- Black or silver, removable cores are standard for all locks
- Pedestal key numbers are randomly assigned to all locking pedestals, except that double pedestal units will be keyed alike
- Master keys and keyed-alike combinations are available

Note: Dimensions assigned in this price list are nominal. If exact measurements are required, the requirement must be specified in the order and specifically acknowledged by Maverick. Maverick reserves the right to change construction details and standards without notification, if necessary.

How to Order Maverick Complete

WORKSURFACE UNITS: DESK, CREDENZAS AND RETURNS

1. Product number: **MC S 36 72 L**
-
- Handle Option
 Width
 Depth
 Product Type: Single Pedestal Desk (See page 66)
 Series Name: Maverick Complete

2. Specify Worksurface Finish. See back cover.
3. Specify Drawer or Door Front Finish (matching color edge is standard). For two colors add \$99 list.
4. Specify Chassis Finish. Matching color edge banding is standard.
5. Specify Handle Options. H3B is standard if none specified.
6. Black grommets are standard where shown.
7. Specify Other Accessories or Upgrades. See pages 105-108.

STANDARD HANDLE OPTIONS

H3B is standard unless otherwise specified.



Crescent Black
(MM H3B)



Crescent Silver
(MM H3S)



Elliptical Black
(MM H5B)



Elliptical Silver
(MM H5S)



Crescent Textured Nickel
(MM H6)



Flared Nickel
(MM H7)



Bow Handle
(MM H8)



Curved Handle
(MM H9)



Bar Square Handle
(MM H10)



Bar Handle
(MM H14)

IMPORTANT NOTE: Handles and locks are standard on All pedestals, lateral files, free standing pedestals and cabinets where specified.

maverick complete

FEATURES

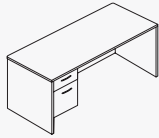

3/4 Pedestal
box/file (S)

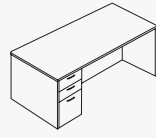

Full Pedestal
box/box/file (C)

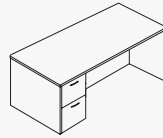

Full Pedestal
file/file (D)

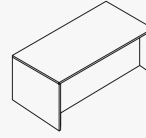

Full Modesty
(FMP)

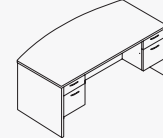

Fan Top
(F)

GROMMETS



GROMMET

Black grommet standard where shown.
Upgrade to silver color, N/C.

NOTE: While sitting at unit, grommet locations named from left to right. For grommet location on tops and/or modesty panel specify left, center or right. **No grommets over pedestals.**

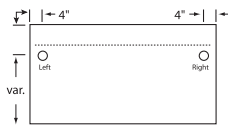

Desks

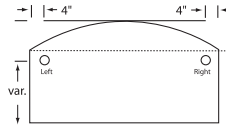

Desks

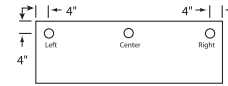

Credenza, Return, Bridges*

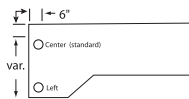

CompuCredenza*

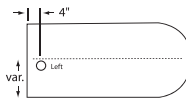

Bullets*

***NOTE: CENTER GROMMET ARE STANDARD WHERE SHOWN**

maverick complete

Statement of Line

DESK

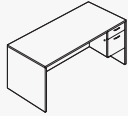

Desk - single pedestal
(S)

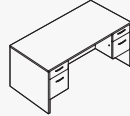

Desk - double pedestal
(D)

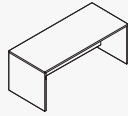

Desk - shell
(N)

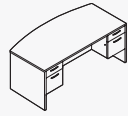

Desk Fan Top - dbl. ped.
(FD)

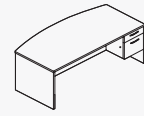

Desk Fan Top - sgl. ped.
(FS)

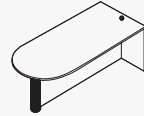

Bullet Desk - standard
(BD)

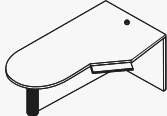

Bullet Computer Desk
(BDC)

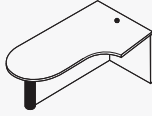

Bullet Computer Desk Curved
(BDCQ)

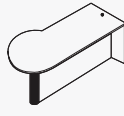

Desk - P-shape
(PBD)

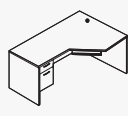

Comp. Desk - sgl. ped.
(CD72 9)

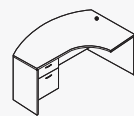

Fan Top Comp. Desk Curved - sgl. ped.
(FCDQ72 9)

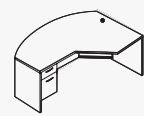

Fan Top Comp. Desk - sgl. ped.
(FCD72 9)

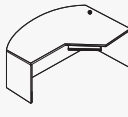

Fan Top Comp. Desk - shell
(FCDN72 9)

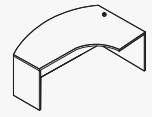

Fan Top Comp. Desk Curved - shell
(FCDNQ72 9)

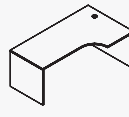

Curve Comp. Desk Shell
(CDNQ72 9)

CREDENZAS

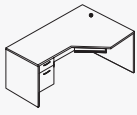

CompuCorner - sgl. ped.
(CD)

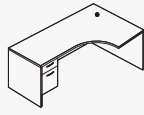

CompuCorner Curved - sgl. ped.
(CDQ)

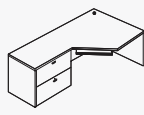

CompuCorner - 31" lateral
(CDLF)

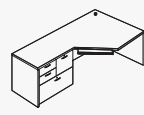

CompuCorner - 31" pers. lat. file
(CDPLF)

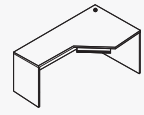

CompuCorner - shell
(CDN)

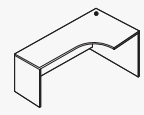

CompuCorner - curved shell
(CDNQ)

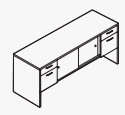

Credenza - dbl. ped. & storage
(C___2)

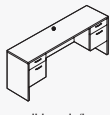

Credenza - dbl. ped. (kneespace)
(C___3)

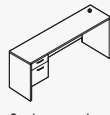

Credenza - sgl. ped.
(C___4)

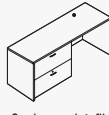

Credenza - lat. file
(C___5)

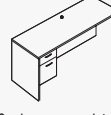

Credenza - pers. lat. file
(C___6)

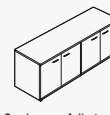

Credenza - full storage
(C___1FP)

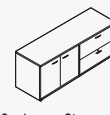

Credenza - Storage File
(C___9FP)

RETURNS

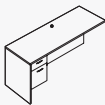

Return - 3/4 ped.
(RA)

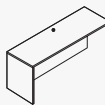

Return - shell
(RN)

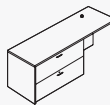

Return - lat. file
(RLF)

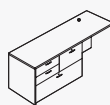

Return - Pers. Lat. File
(RPLF)

RECEPTION

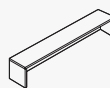

Bridge - reception
(RB)

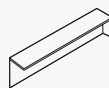

Bridge - reception return
(RBR)

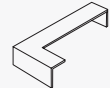

Bridge - reception L
(RBL)

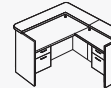

Reception - "L"
(RCAL)

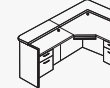

Reception - computer
(RCDL)



Reception - front
(RCAD)

maverick complete

Statement of Line

BRIDGE



Bridge
(BR)

HUTCHES



Hutch - with doors
(H_WD)

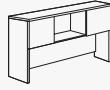

Hutch - 2 door
(H_W2D)

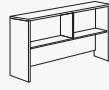

Hutch - no doors
(H_ND)



Hutch - bookcase
(H_BCH)

BOOKCASES



Bookcase
(BC)



Bookcase - storage
(BCD)

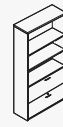

Bookcase - lateral
(BCLF)

FILING



Lateral File
(LF2)



Lateral File - 3-drwr
(LF3)



Lateral File - 4-drwr
(LF4)

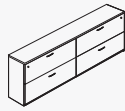

Lateral File - double
(LF_2+2)

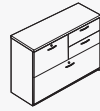

Lateral File - personal
(PLF)



Vertical File
(VF)

STORAGE



Cabinet - single
(STS)

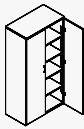

Cabinet - double
(ST)

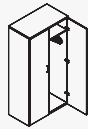

Cabinet - wardrobe
(WC)

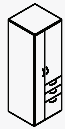

Personal Storage Unit
(WCP)



Cabinet - utility
(HDC)



Cabinet - Wall Mount
(CFOHD)

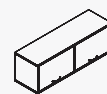

Cabinet - Wall Mount
(CFOHB)

STANDS



Printer Stand
(PS)

PEDESTALS



Mobile - box/box/file
(PEDCX)



Mobile - file/file
(PEDDX)

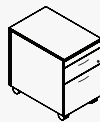

Mobile - Pencil/Box/file
(PEDEX)



Mobile - Box/file
(PEDEX)

maverick complete

Configurations - Are available for  and 

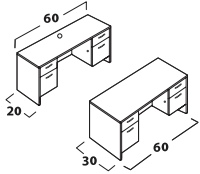

MC1		
1 MCD3060	\$1,209	
1 MCC2060 3	\$1,272	
	\$2,481	

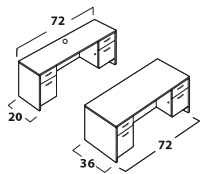

MC2		
1 MCD3672	\$1,463	
1 MCC2072 3	\$1,506	
	\$2,969	

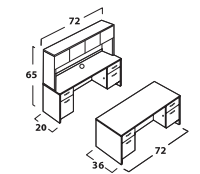

MC3		
1 MCD3672	\$1,463	
1 MCC2072 3	\$1,506	
1 MCH72WD	\$1,364	
	\$4,333	

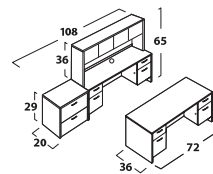

MC4		
1 MCD3672	\$1,463	
1 MCC2072 3	\$1,506	
1 MCH72WD	\$1,364	
1 MCLF202	\$1,088	
	\$5,421	

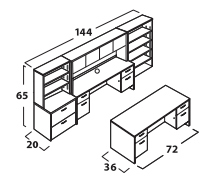

MC5		
1 MCD3672	\$1,463	
1 MCC2072 3	\$1,506	
1 MCH72WD	\$1,364	
1 MCLF202	\$1,088	
1 MCBCH	\$450	
1 MCBC3665	\$734	
	\$6,605	

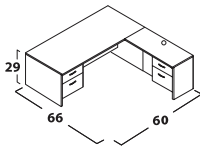

MC6R		
1 MCS3060L	\$982	
1 MCRA2036R	\$921	
	\$1,903	

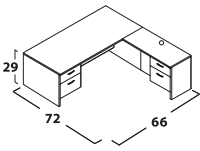

MC7R		
1 MCS3066L	\$1,084	
1 MCRA2442R	\$1,050	
	\$2,134	

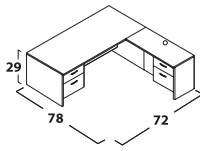

MC8R		
1 MCS3672L	\$1,153	
1 MCRA2442R	\$1,050	
	\$2,203	

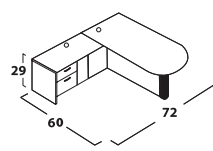

MC9L		
1 MCB3060	\$929	
1 MCRA2042L	\$936	
	\$1,865	

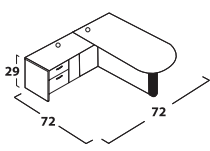

MC10L		
1 MCB3672	\$1,108	
1 MCRA2436L	\$1,021	
	\$2,129	

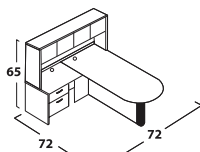

MC11L		
1 MCB3672	\$1,108	
1 MCRA2436L	\$1,021	
1 MCH72WD	\$1,364	
	\$3,493	

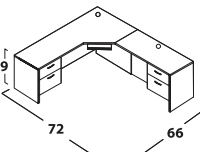

MC13R		
1 MCCD66 4L	\$1,236	
1 MCRA2436R	\$1,021	
	\$2,257	

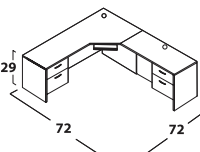

MC14R		
1 MCCD72 4L	\$1,184	
1 MCRA2436R	\$1,021	
	\$2,205	

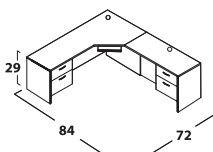

MC15R		
1 MCCD72 4L	\$1,184	
1 MCRA2448R	\$1,063	
	\$2,247	

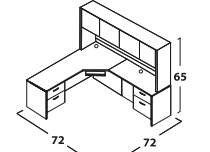

MC16R		
1 MCCD72 4L	\$1,184	
1 MCRA2436R	\$1,021	
1 MCH72WD	\$1,364	
	\$3,569	

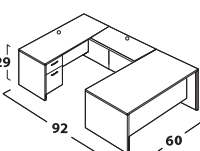

MC17L		
1 MCS3060R	\$982	
1 MCBR2042	\$424	
1 MCC2060 4L	\$1,050	
	\$2,456	

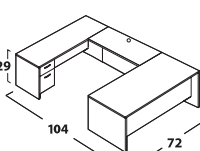

MC18L		
1 MCS3672R	\$1,153	
1 MCBR2448	\$559	
1 MCC2072 4L	\$1,169	
	\$2,881	

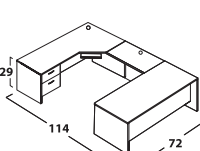

MC19L		
1 MCS3672R	\$1,153	
1 MCBR2442	\$514	
1 MCCD72 4L	\$1,184	
	\$2,851	

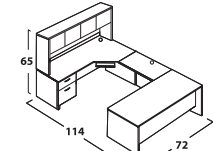

MC20L		
1 MCS3672R	\$1,153	
1 MCBR2442	\$514	
1 MCCD72 4L	\$1,184	
1 MCH72WD	\$1,364	
	\$4,215	

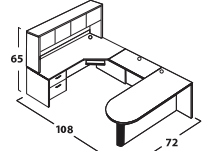

MC22L		
1 MCB3072	\$1,048	
1 MCBR2442	\$514	
1 MCCD72 4L	\$1,184	
1 MCH72WD	\$1,364	
	4,110	

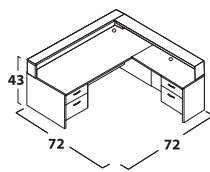

MC23R		
1 MCS3072L	\$1,102	
1 MCRA2442R	\$1,050	
1 MMRB72	\$725	
1 MMRBR60R	\$574	
2 MM GR234B	\$98	
	\$3,549	

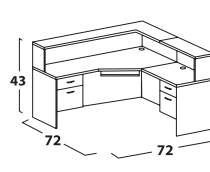

MC25R		
1 MCCD72 4L	\$1,184	
1 MCRA2436R	\$1,021	
1 MMRBL3672R	\$1,060	
1 MMRBR36R	\$356	
1 MM GR234B	\$49	
	\$3,670	

Use "R" or "L" to indicate the position of the return. Configurations are a small sample of total available. Configurations can be used with limited upgrade options for .

maverick complete

Curved Configurations - Are available for  and 

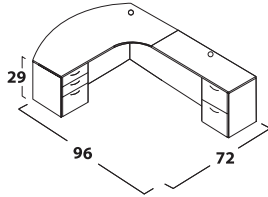

15 DAYS MCQ1R	
1 MCFDQ72C 9L	\$2,097
1 MCRD2448R	\$1,385
	\$3,482

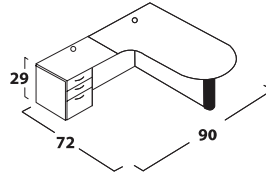

15 DAYS MCQ2L	
1 MCBDCQ427230L	\$1,128
1 MCRC2448L	\$1,450
	\$2,578

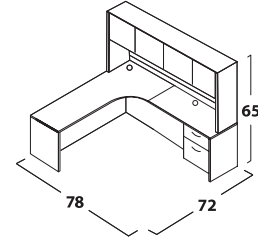

15 DAYS MCQ3R	
1 MCCDNQ72 4R	\$1,018
1 MCRA2436R	\$1,021
1 MCH72WD	\$1,364
	\$3,403

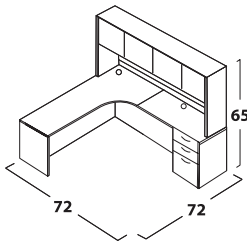

15 DAYS MCQ4R	
1 MCCDNQ72 4R	\$1,018
1 MCRC2436R	\$1,408
1 MCH72WD	\$1,364
	\$3,790

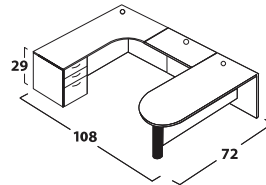

15 DAYS MCQ5L	
1 MCBDC3672	\$1,108
1 MCBR2436	\$441
1 MCCDQ72C 4L	\$1,578
	\$3,127

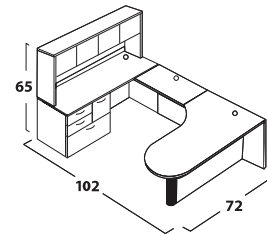

15 DAYS MCQ6L	
1 MCBDCQ427230L	\$1,128
1 MCBR2436	\$441
1 MCC2472 6L	\$1,958
1 MCH72 WD	\$1,364
	\$4,891

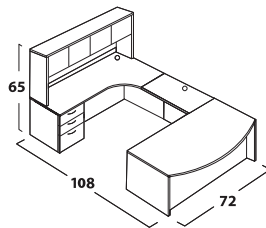

15 DAYS MCQ7L	
1 MCFSC3672R	\$1,787
1 MCBR2436	\$441
1 MCCDQ72C 4L	\$1,578
1 MCH72WD	\$1,364
	\$5,170

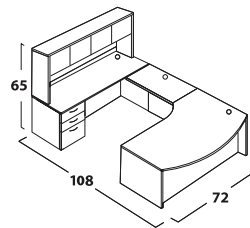

15 DAYS MCQ8L	
1 MCFDQ72C 9R	\$2,097
1 MCBR2436	\$441
1 MCC2472 4L	\$1,587
1 MCH72WD	\$1,364
	\$5,489

maverick complete

Teaming Set-up - Available for  and 

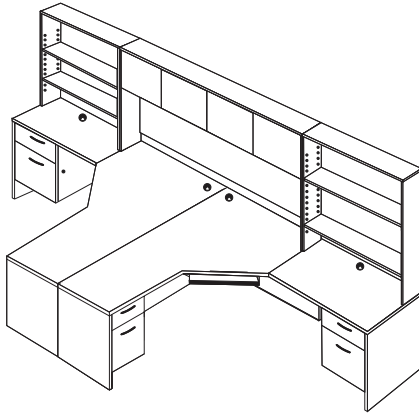

	
1	MCCD72 4R \$1,184
1	MCCD72 4L \$1,184
1	MCRA2436R \$1,021
1	MCRA2436L \$1,021
2	MCBCH \$900
1	MCH72 WD \$1,364
\$6,674	

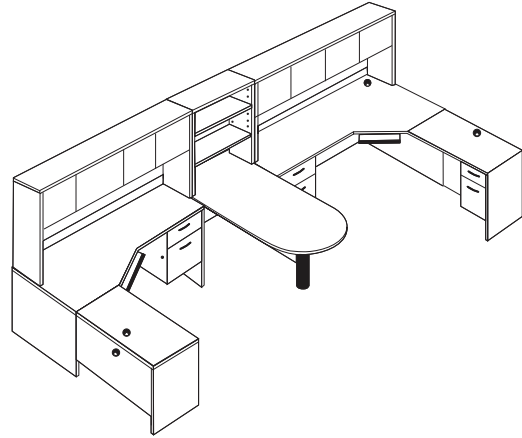

	
1	MCCD72 4R \$1,184
1	MCCD72 4L \$1,184
1	MCRA2436R \$1,021
1	MCRA2436L \$1,021
1	MCBD3672 \$1,108
2	MCH72WD \$2,728
1	MCBCH \$450
\$8,696	

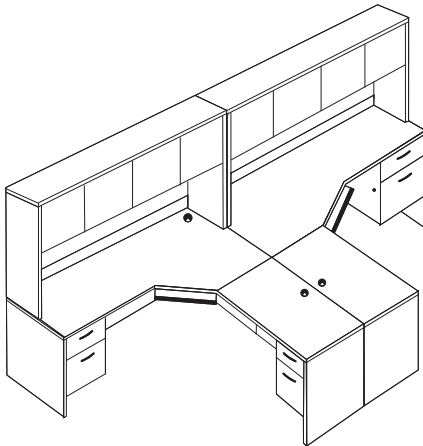

	
1	MCCD72 4R \$1,184
1	MCCD72 4L \$1,184
1	MCRA2436R \$1,021
1	MCRA2436L \$1,021
2	MCH72WD \$2,728
\$7,138	

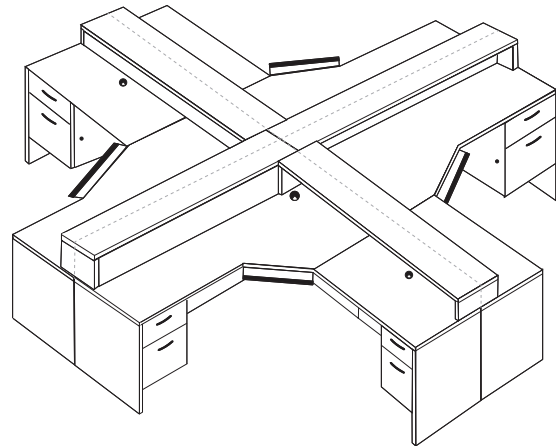

	
2	MCCD72 4R \$2,368
2	MCCD72 4L \$2,368
2	MCRA2436R \$2,042
2	MCRA2436L \$2,042
2	MMRB66 \$1,300
2	MMRB72 \$1,450
\$11,570	

NOTE: Risers center back panel

For pricing on other Maverick Series teaming set-ups, contact your sales representative or Customer Service.

maverick complete

Desks

Single Pedestal Desk, Box/File Pedestal Right (Full modesty, H3B handles, lock)

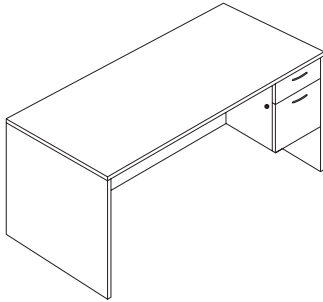

Model#	Depth	Width	Height	Weight	Cube	Price
☞ MCS2042R	20"	42"	29"	120	15	\$ 906
☞ MCS2060R	20"	60"	29"	150	20	\$ 966
☞ MCS2066R	20"	66"	29"	156	23	\$1,072
☞ MCS2072R	20"	72"	29"	163	24	\$1,084
☞ MCS2442R	24"	42"	29"	127	18	\$ 936
☞ MCS2448R	24"	48"	29"	130	20	\$ 953
☞ MCS3048R	30"	48"	29"	142	25	\$ 965
☞ MCS3060R	30"	60"	29"	190	32	\$ 982
☞ MCS3066R	30"	66"	29"	197	35	\$1,084
☞ MCS3072R	30"	72"	29"	210	38	\$1,102
☞ MCS3672R	36"	72"	29"	225	45	\$1,153

Single Pedestal Desk, Box/Box/File Pedestal Right (Full modesty, H3B handles, lock)

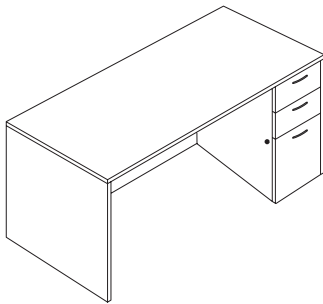

Model#	Depth	Width	Height	Weight	Cube	Price
☞ MCSC2042R	20"	42"	29"	155	15	\$1,301
☞ MCSC2060R	20"	60"	29"	180	20	\$1,358
☞ MCSC2066R	20"	66"	29"	190	23	\$1,466
☞ MCSC2072R	20"	72"	29"	200	24	\$1,481
☞ MCSC2442R	24"	42"	29"	175	18	\$1,332
☞ MCSC2448R	24"	48"	29"	183	20	\$1,347
☞ MCSC3048R	30"	48"	29"	203	25	\$1,358
☞ MCSC3060R	30"	60"	29"	224	32	\$1,375
☞ MCSC3066R	30"	66"	29"	234	35	\$1,481
☞ MCSC3072R	30"	72"	29"	244	38	\$1,496
☞ MCSC3672R	36"	72"	29"	267	45	\$1,549

Single Pedestal Desk, File/File Pedestal Right (Full modesty, H3B handles, lock)

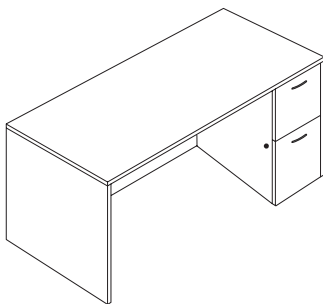

Model#	Depth	Width	Height	Weight	Cube	Price
☞ MCSD2042R	20"	42"	29"	155	15	\$1,237
☞ MCSD2060R	20"	60"	29"	180	20	\$1,295
☞ MCSD2066R	20"	66"	29"	190	23	\$1,400
☞ MCSD2072R	20"	72"	29"	200	24	\$1,415
☞ MCSD2442R	24"	42"	29"	175	18	\$1,265
☞ MCSD2448R	24"	48"	29"	183	20	\$1,280
☞ MCSD3048R	30"	48"	29"	203	25	\$1,295
☞ MCSD3060R	30"	60"	29"	224	32	\$1,311
☞ MCSD3066R	30"	66"	29"	234	35	\$1,415
☞ MCSD3072R	30"	72"	29"	244	38	\$1,431
☞ MCSD3672R	36"	72"	29"	267	45	\$1,484

maverick complete

Desks

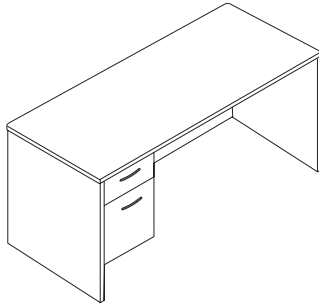

Single Pedestal Desk, Box/File Pedestal Left (Full modesty, H3B handles, lock)

Model#	Depth	Width	Height	Weight	Cube	Price
☞ MCS2042L	20"	42"	29"	120	15	\$ 906
☞ MCS2060L	20"	60"	29"	150	20	\$ 966
☞ MCS2066L	20"	66"	29"	156	23	\$1,072
☞ MCS2072L	20"	72"	29"	163	24	\$1,084
☞ MCS2442L	24"	42"	29"	127	18	\$ 936
☞ MCS2448L	24"	48"	29"	130	20	\$ 953
☞ MCS3048L	30"	48"	29"	142	25	\$ 965
☞ MCS3060L	30"	60"	29"	190	32	\$ 982
☞ MCS3066L	30"	66"	29"	197	35	\$1,084
☞ MCS3072L	30"	72"	29"	210	38	\$1,102
☞ MCS3672L	36"	72"	29"	225	45	\$1,153

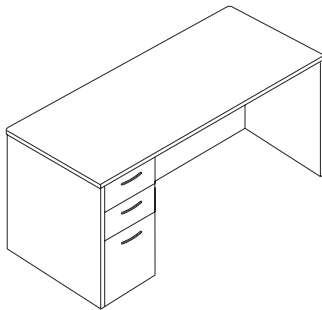

Single Pedestal Desk, Box/Box/File Pedestal Left (Full modesty, H3B handles, lock)

Model#	Depth	Width	Height	Weight	Cube	Price
☞ MCSC2042L	20"	42"	29"	120	15	\$1,301
☞ MCSC2060L	20"	60"	29"	150	20	\$1,358
☞ MCSC2066L	20"	66"	29"	156	23	\$1,466
☞ MCSC2072L	20"	72"	29"	163	24	\$1,481
☞ MCSC2442L	24"	42"	29"	127	18	\$1,332
☞ MCSC2448L	24"	48"	29"	130	20	\$1,347
☞ MCSC3048L	30"	48"	29"	142	25	\$1,358
☞ MCSC3060L	30"	60"	29"	190	32	\$1,375
☞ MCSC3066L	30"	66"	29"	197	35	\$1,481
☞ MCSC3072L	30"	72"	29"	210	38	\$1,496
☞ MCSC3672L	36"	72"	29"	225	45	\$1,549

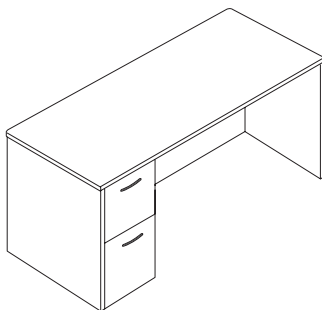

Single Pedestal Desk, File/File Pedestal Left (Full modesty, H3B handles, lock)

Model#	Depth	Width	Height	Weight	Cube	Price
☞ MCSD2042L	20"	42"	29"	120	15	\$1,237
☞ MCSD2060L	20"	60"	29"	150	20	\$1,295
☞ MCSD2066L	20"	66"	29"	156	23	\$1,400
☞ MCSD2072L	20"	72"	29"	163	24	\$1,415
☞ MCSD2442L	24"	42"	29"	127	18	\$1,265
☞ MCSD2448L	24"	48"	29"	130	20	\$1,280
☞ MCSD3048L	30"	48"	29"	142	25	\$1,295
☞ MCSD3060L	30"	60"	29"	190	32	\$1,311
☞ MCSD3066L	30"	66"	29"	197	35	\$1,415
☞ MCSD3072L	30"	72"	29"	210	38	\$1,431
☞ MCSD3672L	36"	72"	29"	225	45	\$1,484

See available accessories and upgrades, pp. 105-108.

maverick complete

Desks

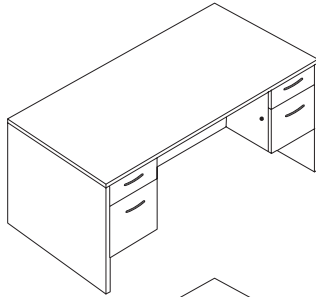

Double Pedestal Desk, Box/File Pedestals Left and Right (Full modesty, H3B Handles, 2 Locks)

Model#	Depth	Width	Height	Weight	Cube	Price
☞ MCD3060	30"	60"	29"	260	32	\$1,209
☞ MCD3066	30"	66"	29"	266	35	\$1,427
☞ MCD3072	30"	72"	29"	270	38	\$1,449
☞ MCD3672	36"	72"	29"	276	45	\$1,463

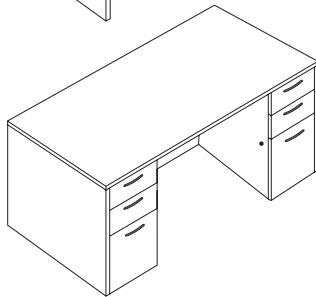

Double Pedestal Desk, Box/Box/File Pedestals Left and Right (Full Modesty, H3B Handles, 2 Locks)

Model#	Depth	Width	Height	Weight	Cube	Price
☞ MCDC3060	30"	60"	29"	294	32	\$1,703
☞ MCDC3066	30"	66"	29"	304	35	\$1,971
☞ MCDC3072	30"	72"	29"	314	38	\$1,993
☞ MCDC3672	36"	72"	29"	337	45	\$2,009

For left Box/Box/File and right File/File configuration use MMFDCD...N/C.

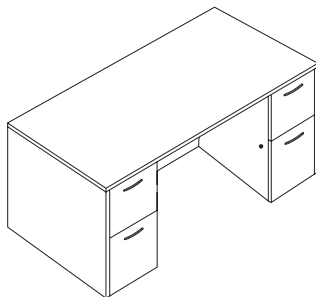

Double Pedestal Desk, File/File Pedestals Left and Right (Full Modesty, H3B Handles, 2 Locks)

Model#	Depth	Width	Height	Weight	Cube	Price
☞ MCDD3060	30"	60"	29"	294	32	\$1,615
☞ MCDD3066	30"	66"	29"	304	35	\$1,884
☞ MCDD3072	30"	72"	29"	314	38	\$1,905
☞ MCDD3672	36"	72"	29"	337	45	\$1,921

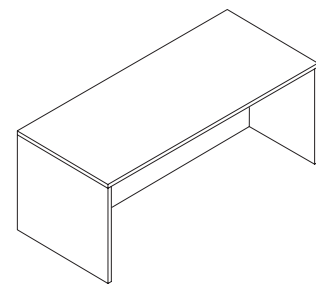

Credenza Shell No-Pedestal (20"D & 24"D, Full modesty flush)

Model#	Depth	Width	Height	Weight	Cube	Price
☞ MCN2042	20"	42"	29"	84	17	\$529
☞ MCN2048	20"	48"	29"	84	17	\$544
☞ MCN2060	20"	60"	29"	92	20	\$581
☞ MCN2066	20"	66"	29"	96	23	\$618
☞ MCN2072	20"	72"	29"	100	24	\$634
☞ MCN2436	24"	36"	29"	89	16	\$534
☞ MCN2442	24"	42"	29"	95	18	\$581
☞ MCN2448	24"	48"	29"	104	20	\$597
☞ MCN2460	24"	60"	29"	120	25	\$634
☞ MCN2466	24"	66"	29"	127	28	\$708
☞ MCN2472	24"	72"	29"	132	30	\$753

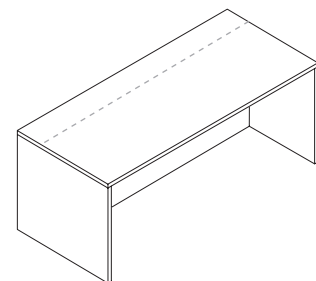

Desk Shell No-Pedestal (Full Modesty...30"D-6" Inset Modesty, 36"D-12" Inset Modesty)

Model#	Depth	Width	Height	Weight	Cube	Price
☞ MCN3042	30"	42"	29"	114	22	\$634
☞ MCN3048	30"	48"	29"	120	25	\$649
☞ MCN3060	30"	60"	29"	126	32	\$666
☞ MCN3066	30"	66"	29"	132	35	\$730
☞ MCN3072	30"	72"	29"	138	38	\$753
☞ MCN3672	36"	72"	29"	152	45	\$767

For left or right 1/2 leg specify on order...N/C.

maverick complete

Desks

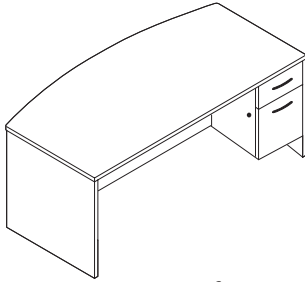

Fan Top Single Pedestal Desk, Box/File Right (Full Modesty, H3B Handles, Lock)

Model#	Depth	Width	Height	Weight	Cube	Price
☞ MCFSC3672R	30-36"	72"	29"	233	45	\$1,393
☞ MCFSC4272R	36-42"	72"	29"	258	53	\$1,437

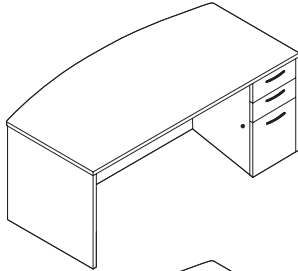

Fan Top Single Pedestal Desk, Box/Box/File Right (Full Modesty, H3B Handles, Lock)

Model#	Depth	Width	Height	Weight	Cube	Price
☞ MCFSC3672R	30-36"	72"	29"	265	45	\$1,787
☞ MCFSC4272R	36-42"	72"	29"	280	53	\$1,832

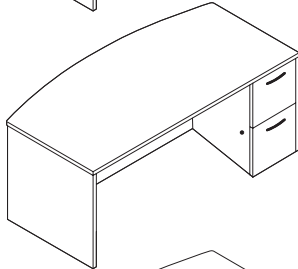

Fan Top Single Pedestal Desk, File/File Right (Full Modesty, H3B Handles, Lock)

Model#	Depth	Width	Height	Weight	Cube	Price
☞ MCFSD3672R	30-36"	72"	29"	265	45	\$1,721
☞ MCFSD4272R	36-42"	72"	29"	280	53	\$1,766

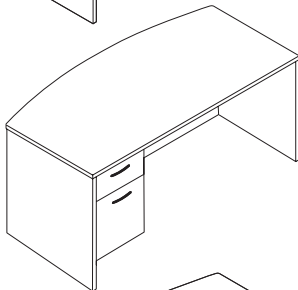

Fan Top Single Pedestal Desk, Box/File Left (Full Modesty, H3B Handles, Lock)

Model#	Depth	Width	Height	Weight	Cube	Price
☞ MCFSC3672L	30-36"	72"	29"	233	45	\$1,393
☞ MCFSC4272L	36-42"	72"	29"	258	53	\$1,437

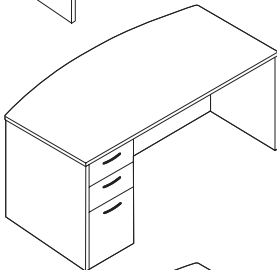

Fan Top Single Pedestal Desk, Box/Box/File Left (Full Modesty, H3B Handles, Lock)

Model#	Depth	Width	Height	Weight	Cube	Price
☞ MCFSC3672L	30-36"	72"	29"	265	45	\$1,787
☞ MCFSC4272L	36-42"	72"	29"	280	53	\$1,832

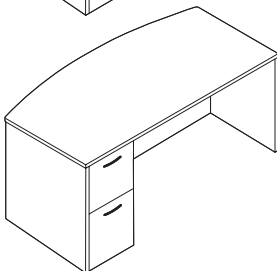

Fan Top Single Pedestal Desk, File/File Left (Full Modesty, H3B Handles, Lock)

Model#	Depth	Width	Height	Weight	Cube	Price
☞ MCFSD3672L	30-36"	72"	29"	265	45	\$1,721
☞ MCFSD4272L	36-42"	72"	29"	280	53	\$1,766

See available accessories and upgrades, pp. 105-108.

maverick complete

Desks

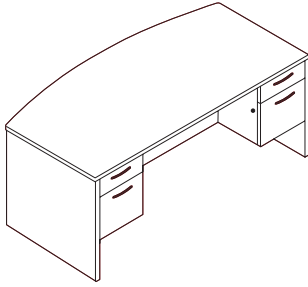

Fan Top Double Pedestal, Box/File Left and Right
(Full Modesty, H3B Handles, 2 Locks)

Model#	Depth	Width	Height	Weight	Cube	Price
☞ MCFD3672	30-36"	72"	29"	280	45	\$1,728
☞ MCFD4272	36-42"	72"	29"	305	53	\$1,742

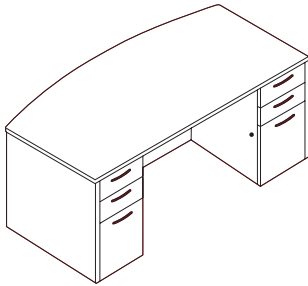

Fan Top Double Pedestal Desk, Box/Box/File Left and Right
(Full Modesty, H3B Handles, 2 Locks)

Model#	Depth	Width	Height	Weight	Cube	Price
☞ MCFDC3672	30-36"	72"	29"	335	45	\$2,221
☞ MCFDC4272	36-42"	72"	29"	350	53	\$2,234

For left Box/Box/File and right File/File configuration use MMFDCD...N/C.

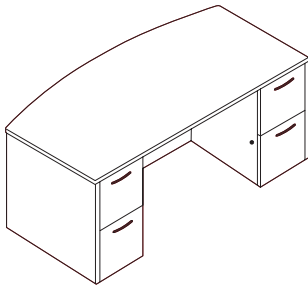

Fan Top Double Pedestal Desk, File/File Left and Right
(Full Modesty, H3B Handles, 2 Locks)

Model#	Depth	Width	Height	Weight	Cube	Price
☞ MCFDD3672	30-36"	72"	29"	335	45	\$2,133
☞ MCFDD4272	36-42"	72"	29"	350	53	\$2,145

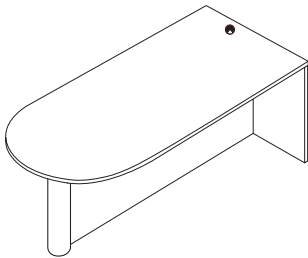

Bullet Desk, (Full modesty, 4" black post, centered black grommet)

Model#	Depth	Width	Height	Weight	Cube	Price
☞ MCBD3060	30"	60"	29"	180	32	\$ 929
☞ MCBD3072	30"	72"	29"	195	35	\$1,048
☞ MCBD3660	36"	60"	29"	185	38	\$1,048
☞ MCBD3672	36"	72"	29"	205	45	\$1,108

For silver post upgrade, add MM UHLEGJS...\$29. Upgrade grommet cover to silver, N/C.
Set-up for left or right connection.

maverick complete

Desks

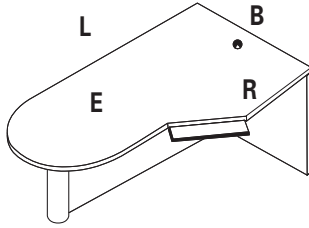

Bullet Computer Desk (Full modesty, 4" black post), For Right Return

Model#	Depth (B,E)	Width (L,R)	Height	Weight	Cube	Price
☞ MCBDC427230R	42/30"	72"/24"	29"	195	53	\$1,128
☞ MCBDC427830R	42/30"	78"/24"	29"	205	58	\$1,367

Keyboard tray and worksurface black grommet are standard. Upgrade grommet cover to silver, N/C. For silver post upgrade, add MM UHLEGJS...\$29.

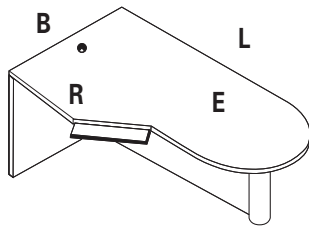

Bullet Computer Desk (Full modesty, 4" black post), For Left Return

Model#	Depth (B,E)	Width (L,R)	Height	Weight	Cube	Price
☞ MCBDC427230L	42/30"	72"/24"	29"	195	53	\$1,128
☞ MCBDC427830L	42/30"	78"/24"	29"	205	58	\$1,367

Keyboard tray and worksurface black grommet are standard. Upgrade grommet cover to silver, N/C. For silver post upgrade, add MM UHLEGJS...\$29.

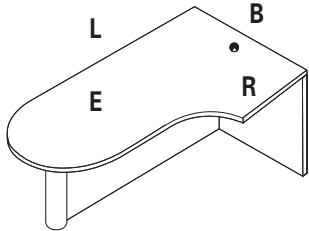

Bullet Computer Desk, Curved (Full modesty, 4" black post), For Right Return

Model#	Depth (B,E)	Width (L,R)	Height	Weight	Cube	Price
☞ MCBDCQ427230R	42/30"	72"/24"	29"	195	53	\$1,128

Worksurface black grommet standard. Upgrade grommet cover to silver, N/C. For silver post upgrade, add MM UHLEGJS...\$29.

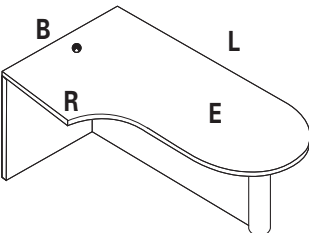

Bullet Computer Desk, Curved (Full modesty, 4" black post), For Left Return

Model#	Depth (B,E)	Width (L,R)	Height	Weight	Cube	Price
☞ MCBDCQ427230L	42/30"	72"/24"	29"	195	53	\$1,128

Worksurface black grommet standard. Upgrade grommet cover to silver, N/C. For silver post upgrade, add MM UHLEGJS...\$29.

maverick complete

Desks

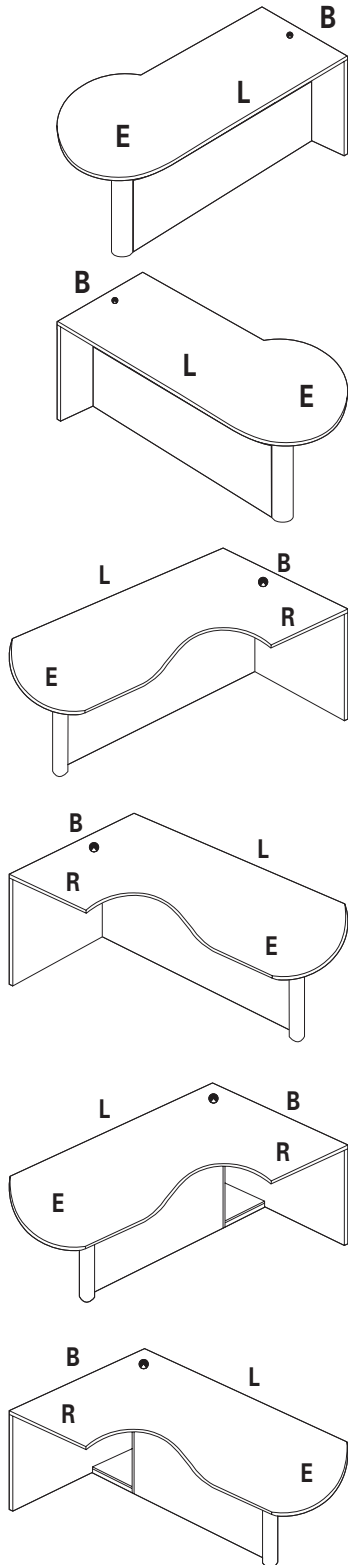

P-shape Desk (Full modesty, 4" black post), For Right Return

Model#	Depth (B,E)	Width (L)	Height	Weight	Cube	Price
MCPBD3072R	30/36"	72"	29"	200	45	\$1,250
MCPBD3672R	36/42"	72"	29"	205	53	\$1,311
MCPBD3678R	36/42"	78"	29"	215	49	\$1,416
MCPBD3684R	36/42"	84"	29"	225	62	\$1,618

Black grommet standard. Upgrade grommet cover to silver, N/C. For silver post upgrade, add MM UHLEGJS...\$29.

P-shape Desk (Full modesty, 4" black post), For Left Return

Model#	Depth (B,E)	Width (L)	Height	Weight	Cube	Price
MCPBD3072L	30/36"	72"	29"	200	45	\$1,250
MCPBD3672L	36/42"	72"	29"	205	53	\$1,311
MCPBD3678L	36/42"	78"	29"	215	49	\$1,416
MCPBD3684L	36/42"	84"	29"	225	62	\$1,618

Black grommet standard. Upgrade grommet cover to silver, N/C. For silver post upgrade, add MM UHLEGJS...\$29.

Arc End Computer Desk (Full modesty, 4" black post), For Right Return

Model#	Depth (B,E)	Width (L,R)	Height	Weight	Cube	Price
MCAE427236R	42/36"	72"/24"	29"	205	53	\$1,382
MCAE427836R	42/36"	78"/24"	29"	215	58	\$1,497

Black grommet standard. Upgrade grommet cover to silver, N/C. For silver post upgrade, add MM UHLEGJS...\$29.

Arc End Computer Desk (Full modesty, 4" black post), For Left Return

Model#	Depth (B,E)	Width (L,R)	Height	Weight	Cube	Price
MCAE427236L	42/36"	72"/24"	29"	205	53	\$1,382
MCAE427836L	42/36"	78"/24"	29"	215	58	\$1,497

Black grommet standard. Upgrade grommet cover to silver, N/C. For silver post upgrade, add MM UHLEGJS...\$29.

Arc End Computer Desk with CPU Storage Cabinet (Full modesty, 4" black post), For Right Return

Model#	Depth (B,E)	Width (L,R)	Height	Weight	Cube	Price
MCAEC427236R	42/36"	72"/24"	29"	205	53	\$1,495
MCAEC427836R	42/36"	78"/24"	29"	215	58	\$1,701

Black grommet standard. Upgrade grommet cover to silver, N/C. For silver post upgrade, add MM UHLEGJS...\$29.

Arc End Computer Desk with CPU Storage Cabinet (Full modesty, 4" black post), For Left Return

Model#	Depth (B,E)	Width (L,R)	Height	Weight	Cube	Price
MCAEC427236L	42/36"	72"/24"	29"	205	53	\$1,495
MCAEC427836L	42/36"	78"/24"	29"	215	58	\$1,701

Black grommet standard. Upgrade grommet cover to silver, N/C. For silver post upgrade, add MM UHLEGJS...\$29.

maverick complete

Desks

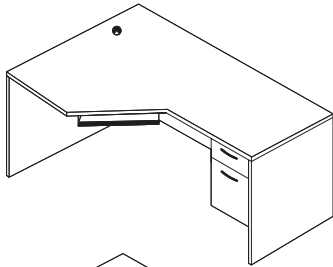

Computer Desk, Box/File Pedestal Right
(Front unit, full modesty inset 6", H3B Handles, Lock)

Model	(L)	(B)	(E)	(K)	(R)	(W)	Weight	Cube	Price
MCCD72 9R	72"	42"	30"	24"	24"	27"	285	45	\$1,588

Keyboard tray and worksurface black grommet are standard. Upgrade grommet cover to silver, N/C.

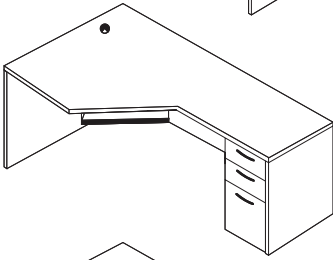

Computer Desk, Box/Box/File Pedestal Right
(Front unit, full modesty inset 6", H3B Handles, Lock)

Model	(L)	(B)	(E)	(K)	(R)	(W)	Weight	Cube	Price
MCCD72C 9R	72"	42"	30"	24"	24"	27"	300	45	\$1,982

Keyboard tray and worksurface black grommet are standard. Upgrade grommet cover to silver, N/C.

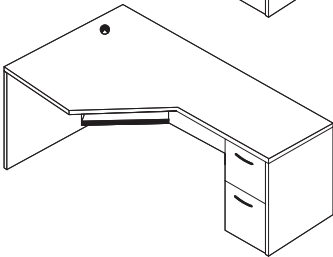

Computer Desk, File/File Pedestal Right
(Front unit, full modesty inset 6", H3B Handles, Lock)

Model	(L)	(B)	(E)	(K)	(R)	(W)	Weight	Cube	Price
MCCD72D 9R	72"	42"	30"	24"	24"	27"	300	45	\$1,919

Keyboard tray and worksurface black grommet are standard. Upgrade grommet cover to silver, N/C.

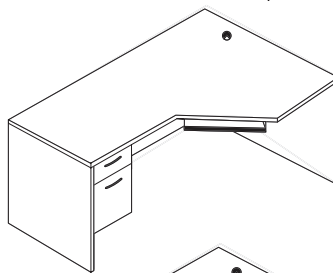

Computer Desk, Box/File Pedestal Left
(Front unit, Full modesty inset 6", H3B Handles, Lock)

Model	(L)	(B)	(E)	(K)	(R)	(W)	Weight	Cube	Price
MCCD72 9L	72"	42"	30"	24"	24"	27"	285	45	\$1,588

Keyboard tray and worksurface black grommet are standard. Upgrade grommet cover to silver, N/C.

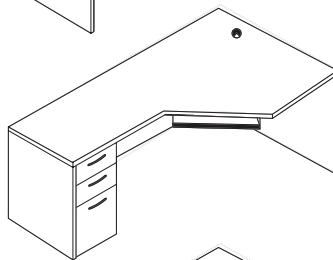

Computer Desk, Box/Box/File Pedestal Left
(Front unit, Full modesty inset 6", H3B Handles, Lock)

Model	(L)	(B)	(E)	(K)	(R)	(W)	Weight	Cube	Price
MCCD72C 9L	72"	42"	30"	24"	24"	27"	300	45	\$1,982

Keyboard tray and worksurface black grommet are standard. Upgrade grommet cover to silver, N/C.

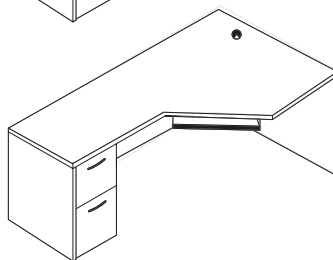

Computer Desk, File/File Pedestal Left
(Front unit, Full modesty inset 6", H3B Handles, Lock)

Model	(L)	(B)	(E)	(K)	(R)	(W)	Weight	Cube	Price
MCCD72D 9L	72"	42"	30"	24"	24"	27"	300	45	\$1,919

Keyboard tray and worksurface black grommet are standard. Upgrade grommet cover to silver, N/C.

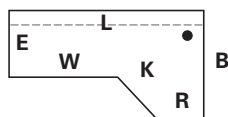

- "L" Length along approach edge
- "B" Back end panel
- "E" End panel
- "K" Keyboard space
- "R" Return size to attach
- "W" Workarea (kbrd to end)

See available accessories and upgrades, pp. 105-108.

maverick complete

Desks

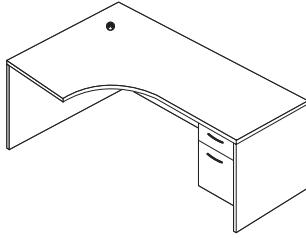

Computer Desk, Curved, Box/File Pedestal Right
(Front unit, Full modesty inset 6", H3B Handles, Lock)

Model	(L)	(B)	(E)	(K)	(R)	(W)	Weight	Cube	Price
MCCDQ72 9R	72"	42"	30"	24"	24"	27"	285	45	\$1,588

No keyboard tray. Worksurface black grommet standard. Upgrade grommet cover to silver, N/C.

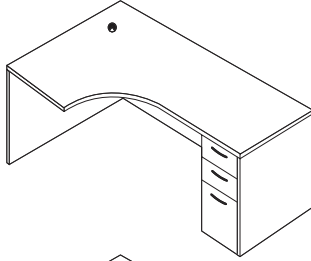

Computer Desk, Curved, Box/Box/File Pedestal Right
(Front unit, Full modesty inset 6", H3B Handles, Lock)

Model	(L)	(B)	(E)	(K)	(R)	(W)	Weight	Cube	Price
MCCDQ72C 9R	72"	42"	30"	24"	24"	27"	300	45	\$1,982

No keyboard tray. Worksurface black grommet standard. Upgrade grommet cover to silver, N/C.

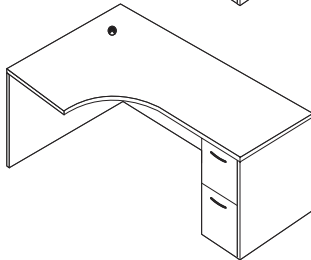

Computer Desk, Curved, File/File Pedestal Right
(Front unit, Full modesty inset 6", H3B Handles, Lock)

Model	(L)	(B)	(E)	(K)	(R)	(W)	Weight	Cube	Price
MCCDQ72D 9R	72"	42"	30"	24"	24"	27"	300	45	\$1,919

No keyboard tray. Worksurface black grommet standard. Upgrade grommet cover to silver, N/C.

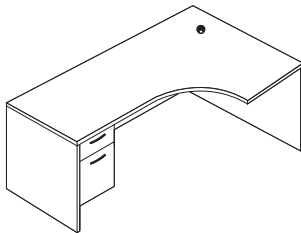

Computer Desk, Curved, Box/File Pedestal Left
(Front unit, Full modesty inset 6", H3B Handles, Lock)

Model	(L)	(B)	(E)	(K)	(R)	(W)	Weight	Cube	Price
MCCDQ72 9L	72"	42"	30"	24"	24"	27"	285	45	\$1,588

No keyboard tray. Worksurface black grommet standard. Upgrade grommet cover to silver, N/C.

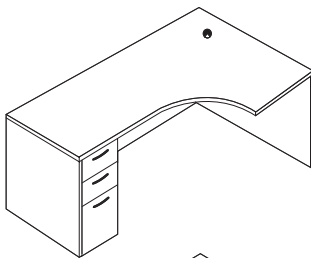

Computer Desk, Curved, Box/Box/File Pedestal Left
(Front unit, Full modesty inset 6", H3B Handles, Lock)

Model	(L)	(B)	(E)	(K)	(R)	(W)	Weight	Cube	Price
MCCDQ72C 9L	72"	42"	30"	24"	24"	27"	300	45	\$1,982

No keyboard tray. Worksurface black grommet standard. Upgrade grommet cover to silver, N/C.

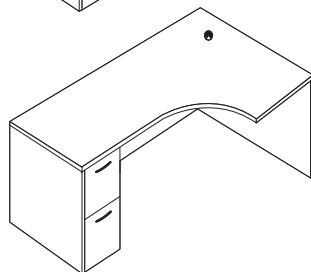

Computer Desk, Curved, File/File Pedestal Left
(Front unit, Full modesty inset 6", H3B Handles, Lock)

Model	(L)	(B)	(E)	(K)	(R)	(W)	Weight	Cube	Price
MCCDQ72D 9L	72"	42"	30"	24"	24"	27"	300	45	\$1,919

No keyboard tray. Worksurface black grommet standard. Upgrade grommet cover to silver, N/C.

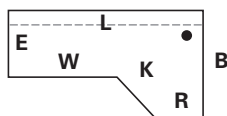

- "L" Length along approach edge
- "B" Back end panel
- "E" End panel
- "K" Keyboard space
- "R" Return size to attach
- "W" Workarea (kbrd to end)

See available accessories and upgrades, pp. 105-108.

maverick complete

Desks

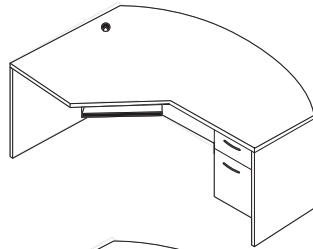

Fan Top Computer Desk, Box/File Pedestal Right
(Front unit, Full modesty inset 6", H3B Handles, Lock)

Model	(L)	(B)	(E)	(K)	(R)	(W)	Weight	Cube	Price
MCFC72 9R	72"	42"	+ 30"	24"	24"	27"	295	48	\$1,700

Keyboard tray and worksurface black grommet are standard. Fan front adds 6" to overall depth. Upgrade grommet cover to silver, N/C.

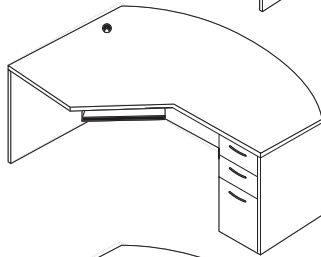

Fan Top Computer Desk, Box/Box/File Pedestal Right
(Front Unit, full modesty inset 6", H3B Handles, Lock)

Model	(L)	(B)	(E)	(K)	(R)	(W)	Weight	Cube	Price
MCFC72C 9R	72"	42"	+ 30"	24"	24"	27"	310	48	\$2,097

Keyboard tray and worksurface black grommet are standard. Fan front adds 6" to overall depth. Upgrade grommet cover to silver, N/C.

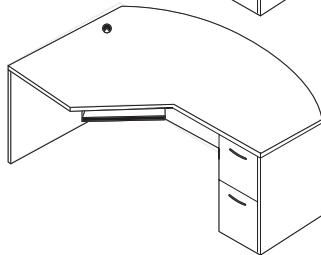

Fan Top Computer Desk, File/File Pedestal Right
(Front Unit, full modesty inset 6", H3B Handles, Lock)

Model	(L)	(B)	(E)	(K)	(R)	(W)	Weight	Cube	Price
MCFC72D 9R	72"	42"	+ 30"	24"	24"	27"	310	48	\$2,030

Keyboard tray and worksurface black grommet are standard. Fan front adds 6" to overall depth. Upgrade grommet cover to silver, N/C.

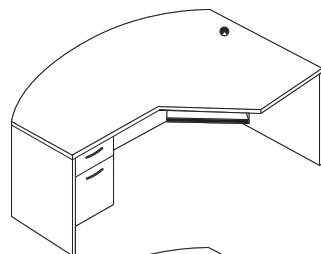

Fan Top Computer Desk, Box/File Pedestal Left
(Front unit, Full modesty inset 6", H3B Handles, Lock)

Model	(L)	(B)	(E)	(K)	(R)	(W)	Weight	Cube	Price
MCFC72 9L	72"	42"	+ 30"	24"	24"	27"	295	48	\$1,700

Keyboard tray and worksurface black grommet are standard. Upgrade grommet cover to silver, N/C. Fan front adds 6" to overall depth.

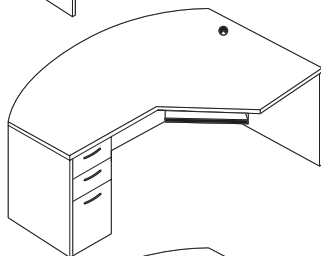

Fan Top Computer Desk, Box/Box/File Pedestal Left
(Front unit, Full modesty inset 6", H3B Handles, Lock)

Model	(L)	(B)	(E)	(K)	(R)	(W)	Weight	Cube	Price
MCFC72C 9L	72"	42"	+ 30"	24"	24"	27"	310	48	\$2,097

Keyboard tray and worksurface black grommet are standard. Upgrade grommet cover to silver, N/C. Fan front adds 6" to overall depth.

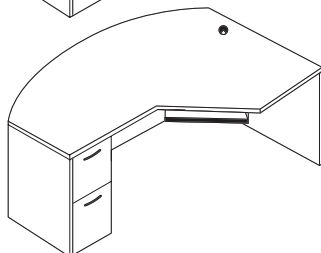

Fan Top Computer Desk, File/File Pedestal Left
(Front unit, Full modesty inset 6", H3B Handles, Lock)

Model	(L)	(B)	(E)	(K)	(R)	(W)	Weight	Cube	Price
MCFC72D 9L	72"	42"	+ 30"	24"	24"	27"	310	48	\$2,030

Keyboard tray and worksurface black grommet are standard. Upgrade grommet cover to silver, N/C. Fan front adds 6" to overall depth.

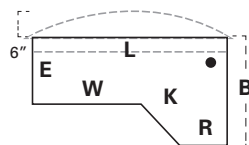

- "L" Length along approach edge
- "B" Back end panel (Fan top adds 6")
- "E" End panel
- "K" Keyboard space
- "R" Return size to attach
- "W" Workarea (kbrd to end)

See available accessories and upgrades, pp. 105-108.

maverick complete

Desks

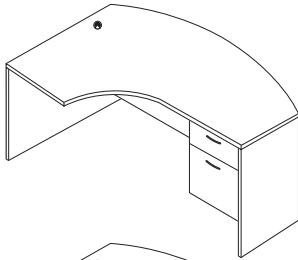

Fan Top Computer Desk, Curved, Box/File Pedestal Right
(Front unit, Full modesty inset 6", H3B Handles, Lock)

Model	(L)	(B)	(E)	(K)	(R)	(W)	Weight	Cube	Price
MCFCDQ72 9R	72"	42"	+ 30"	24"	24"	27"	295	48	\$1,700

No keyboard tray. Worksurface black grommet standard. Fan front adds 6" to overall depth.
Upgrade grommet cover to silver, N/C.

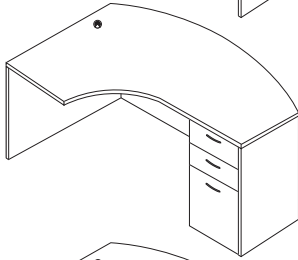

Fan Top Computer Desk, Curved, Box/Box/File Pedestal Right
(Front unit, Full modesty inset 6", H3B Handles, Lock)

Model	(L)	(B)	(E)	(K)	(R)	(W)	Weight	Cube	Price
MCFCDQ72C 9R	72"	42"	+ 30"	24"	24"	27"	310	48	\$2,097

No keyboard tray, worksurface black grommet standard. Fan front adds 6" to overall depth.
Upgrade grommet cover to silver, N/C.

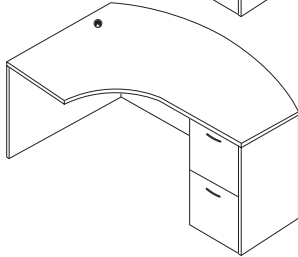

Fan Top Computer Desk, Curved, File/File Pedestal Right
(Front unit, Full modesty inset 6", H3B Handles, Lock)

Model	(L)	(B)	(E)	(K)	(R)	(W)	Weight	Cube	Price
MCFCDQ72D 9R	72"	42"	+ 30"	24"	24"	27"	310	48	\$2,030

No keyboard tray, worksurface black grommet standard. Fan front adds 6" to overall depth.
Upgrade grommet cover to silver, N/C.

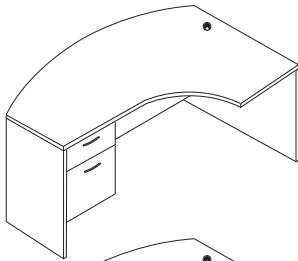

Fan Top Computer Desk, Curved, Box/File Pedestal Left
(Front Unit, Full modesty inset 6", H3B Handles, Lock)

Model	(L)	(B)	(E)	(K)	(R)	(W)	Weight	Cube	Price
MCFCDQ72 9L	72"	42"	+ 30"	24"	24"	27"	295	48	\$1,700

No keyboard tray, worksurface black grommet standard. Fan front adds 6" to overall depth.
Upgrade grommet cover to silver, N/C.

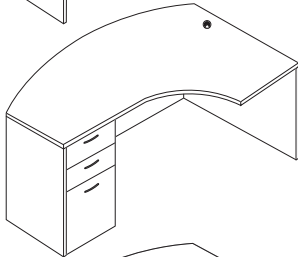

Fan Top Computer Desk, Curved, Box/Box/File Pedestal Left
(Front unit, Full modesty inset 6", H3B Handles, Lock)

Model	(L)	(B)	(E)	(K)	(R)	(W)	Weight	Cube	Price
MCFCDQ72C 9L	72"	42"	+ 30"	24"	24"	27"	310	48	\$2,097

No keyboard tray, worksurface black grommet standard. Fan front adds 6" to overall depth.
Upgrade grommet cover to silver, N/C.

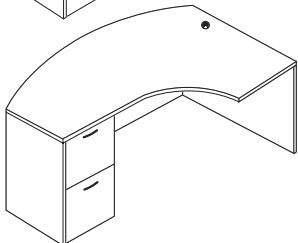

Fan Top Computer Desk, Curved, File/File Pedestal Left
(Front unit, Full modesty inset 6", H3B Handles, Lock)

Model	(L)	(B)	(E)	(K)	(R)	(W)	Weight	Cube	Price
MCFCDQ72D 9L	72"	42"	+ 30"	24"	24"	27"	310	48	\$2,030

No keyboard tray worksurface black grommet standard. Fan front adds 6" to overall depth.
Upgrade grommet cover to silver, N/C.

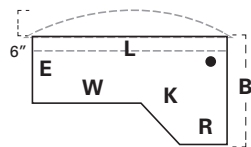

- "L" Length along approach edge
- "B" Back end panel (Fan top adds 6")
- "E" End panel
- "K" Keyboard space
- "R" Return size to attach
- "W" Workarea (kbrd to end)

See available accessories and upgrades, pp. 105-108.

maverick complete

Desks

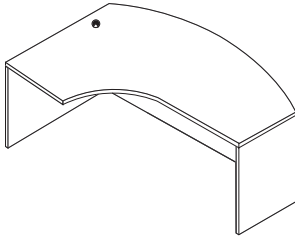

Fan Top Computer Desk Shell, Curved (Front unit, Full modesty inset 6"), For Left Return

Model	(L)	(B)	(E)	(K)	(R)	(W)	Weight	Cube	Price
MCFCDNQ72 9L	72"	42"	+ 30"	24"	24"	27"	215	48	\$1,293

No keyboard tray. Worksurface black grommet standard. Upgrade grommet cover to silver, N/C.
Fan front adds 6" to overall depth.

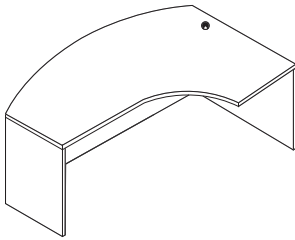

Fan Top Computer Desk Shell, Curved (Front unit, Full modesty inset 6"), For Right Return

Model	(L)	(B)	(E)	(K)	(R)	(W)	Weight	Cube	Price
MCFCDNQ72 9R	72"	42"	+ 30"	24"	24"	27"	215	48	\$1,293

No keyboard tray. Worksurface black grommet standard. Upgrade grommet cover to silver, N/C.
Fan front adds 6" to overall depth.

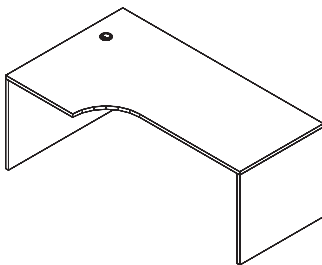

Computer Desk Shell, Curved (Front unit, Full modesty inset 6") For Left Return

Model#	(L)	(B)	(E)	(K)	(R)	(W)	Weight	Cube	Price
MCCDNQ72 9L	72"	42"	30"	24"	24"	27"	215	51	\$1,293

No keyboard tray. Worksurface black grommet standard. Upgrade grommet cover to silver, N/C.

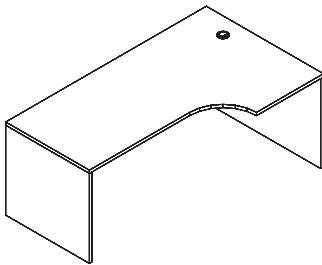

Computer Desk Shell, Curved (Front unit, Full modesty inset 6") For Right Return

Model#	(L)	(B)	(E)	(K)	(R)	(W)	Weight	Cube	Price
MCCDNQ72 9R	72"	42"	30"	24"	24"	27"	215	51	\$1,293

No keyboard tray. Worksurface black grommet standard. Upgrade grommet cover to silver, N/C.

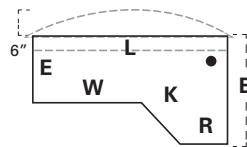

- "L" Length along approach edge
- "B" Back end panel (Fan top adds 6")
- "E" End panel
- "K" Keyboard space
- "R" Return size to attach
- "W" Workarea (kbd to end)

maverick complete

Bridges

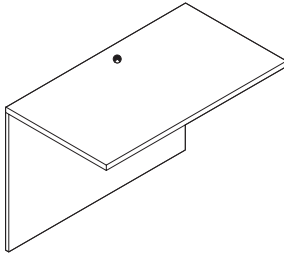

Bridge Full Modesty (Flush height)

Model#	Depth	Width	Height	Weight	Cube	Price
☞ MCBR2036	20"	36"	29"	41	9	\$408
☞ MCBR2042	20"	42"	29"	48	10	\$424
☞ MCBR2048	20"	48"	29"	55	12	\$469
☞ MCBR2436	24"	36"	29"	47	10	\$441
☞ MCBR2442	24"	42"	29"	55	12	\$514
☞ MCBR2448	24"	48"	29"	63	14	\$559
☞ MCBR2460	24"	60"	29"	78	15	\$642

Full modesty standard. ½ modesty on bridges may be specified at no upcharge.
Black grommet center top and modesty. Upgrade grommet cover to silver, N/C.
60"W bridge requires ½ leg center support, add MMSPT113.

Returns

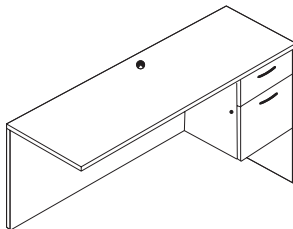

Return, ¾ Box/File Pedestal Right (Full modesty, flush height, H3B Handles, Lock)

Model#	Depth	Width	Height	Weight	Cube	Price
☞ MCRA2036R	20"	36"	29"	95	13	\$ 921
☞ MCRA2042R	20"	42"	29"	104	15	\$ 936
☞ MCRA2048R	20"	48"	29"	110	17	\$ 952
☞ MCRA2054R	20"	54"	29"	117	19	\$ 982
☞ MCRA2436R	24"	36"	29"	100	15	\$1,021
☞ MCRA2442R	24"	42"	29"	107	18	\$1,050
☞ MCRA2448R	24"	48"	29"	114	20	\$1,063
☞ MCRA2454R	24"	54"	29"	121	23	\$1,125
☞ MCRA2460R	24"	60"	29"	124	24	\$1,138
☞ MCRA3048R	30"	48"	29"	127	25	\$1,138

Full modesty standard. ½ modesty on returns may be specified at no upcharge.
Black grommet center top and modesty. Upgrade grommet cover to silver, N/C.

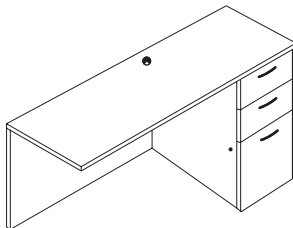

Return, Box/Box/File Pedestal Right (Full modesty, H3B Handles, Lock)

Model#	Depth	Width	Height	Weight	Cube	Price
☞ MCRC2036R	20"	36"	29"	130	13	\$1,311
☞ MCRC2042R	20"	42"	29"	140	15	\$1,322
☞ MCRC2048R	20"	48"	29"	150	17	\$1,340
☞ MCRC2054R	20"	54"	29"	160	19	\$1,371
☞ MCRC2436R	24"	36"	29"	140	15	\$1,408
☞ MCRC2442R	24"	42"	29"	150	18	\$1,438
☞ MCRC2448R	24"	48"	29"	160	20	\$1,450
☞ MCRC2454R	24"	54"	29"	170	23	\$1,514
☞ MCRC2460R	24"	60"	29"	180	24	\$1,526
☞ MCRC3048R	30"	48"	29"	175	25	\$1,526

Full modesty standard. ½ modesty on returns may be specified at no upcharge.
Black grommet center top and modesty. Upgrade grommet cover to silver, N/C.

maverick complete

Returns

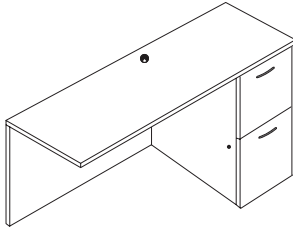

Return, File/File Pedestal Right (Full modesty, H3B Handles, Lock)

Model#	Depth	Width	Height	Weight	Cube	Price
☞ MCRD2036R	20"	36"	29"	130	13	\$1,244
☞ MCRD2042R	20"	42"	29"	140	15	\$1,258
☞ MCRD2048R	20"	48"	29"	150	17	\$1,274
☞ MCRD2054R	20"	54"	29"	160	19	\$1,305
☞ MCRD2436R	24"	36"	29"	140	15	\$1,344
☞ MCRD2442R	24"	42"	29"	150	18	\$1,359
☞ MCRD2448R	24"	48"	29"	160	20	\$1,385
☞ MCRD2454R	24"	54"	29"	170	23	\$1,448
☞ MCRD2460R	24"	60"	29"	180	24	\$1,461
☞ MCRD3048R	30"	48"	29"	175	25	\$1,461

Full modesty standard. ½ modesty on returns may be specified at no upcharge.
Black grommet center top and modesty. Upgrade grommet cover to silver, N/C.

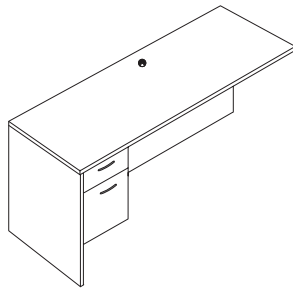

Return, ¾ Box/File Pedestal Left (Full modesty, H3B Handles, Lock)

Model#	Depth	Width	Height	Weight	Cube	Price
☞ MCRA2036L	20"	36"	29"	95	13	\$ 921
☞ MCRA2042L	20"	42"	29"	104	15	\$ 936
☞ MCRA2048L	20"	48"	29"	110	17	\$ 952
☞ MCRA2054L	20"	54"	29"	117	19	\$ 982
☞ MCRA2436L	24"	36"	29"	100	15	\$1,021
☞ MCRA2442L	24"	42"	29"	107	18	\$1,050
☞ MCRA2448L	24"	48"	29"	114	20	\$1,063
☞ MCRA2454L	24"	54"	29"	121	23	\$1,125
☞ MCRA2460L	24"	60"	29"	124	24	\$1,138
☞ MCRA3048L	30"	48"	29"	127	25	\$1,138

Full modesty standard. ½ modesty on returns may be specified at no upcharge.
Black grommet center top and modesty. Upgrade grommet cover to silver, N/C.

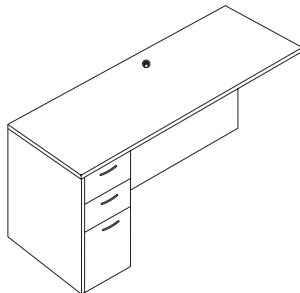

Return, Box/Box/File Pedestal Left (Full modesty, H3B Handles, Lock)

Model#	Depth	Width	Height	Weight	Cube	Price
☞ MCRC2036L	20"	36"	29"	130	13	\$1,311
☞ MCRC2042L	20"	42"	29"	140	15	\$1,322
☞ MCRC2048L	20"	48"	29"	150	17	\$1,340
☞ MCRC2054L	20"	54"	29"	160	19	\$1,371
☞ MCRC2436L	24"	36"	29"	140	15	\$1,408
☞ MCRC2442L	24"	42"	29"	150	18	\$1,438
☞ MCRC2448L	24"	48"	29"	160	20	\$1,450
☞ MCRC2454L	24"	54"	29"	170	23	\$1,514
☞ MCRC2460L	24"	60"	29"	180	24	\$1,526
☞ MCRC3048L	30"	48"	29"	175	25	\$1,526

Full modesty standard. ½ modesty on returns may be specified at no upcharge.
Black grommet center top and modesty. Upgrade grommet cover to silver, N/C.

maverick complete

Returns

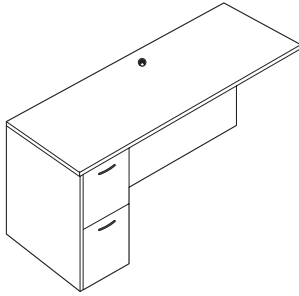

Return, File/File Pedestal Left (Full modesty, H3B Handles, Lock)

Model#	Depth	Width	Height	Weight	Cube	Price
☞ MCRD2036L	20"	36"	29"	130	13	\$1,244
☞ MCRD2042L	20"	42"	29"	140	15	\$1,258
☞ MCRD2048L	20"	48"	29"	150	17	\$1,274
☞ MCRD2054L	20"	54"	29"	160	19	\$1,305
☞ MCRD2436L	24"	36"	29"	140	15	\$1,344
☞ MCRD2442L	24"	42"	29"	150	18	\$1,359
☞ MCRD2448L	24"	48"	29"	160	20	\$1,385
☞ MCRD2454L	24"	54"	29"	170	23	\$1,448
☞ MCRD2460L	24"	60"	29"	180	24	\$1,461
☞ MCRD3048L	30"	48"	29"	175	25	\$1,461

Full modesty standard. ½ modesty on returns may be specified at no upcharge.
Black grommet center top and modesty. Upgrade grommet cover to silver, N/C.

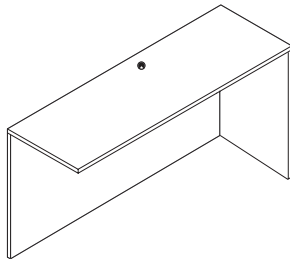

Return Shell Right (Full modesty, Flush height)

Model#	Depth	Width	Height	Weight	Cube	Price
☞ MCRN2036R	20"	36"	29"	60	13	\$514
☞ MCRN2042R	20"	42"	29"	67	15	\$529
☞ MCRN2048R	20"	48"	29"	73	17	\$579
☞ MCRN2054R	20"	54"	29"	80	19	\$626
☞ MCRN2436R	24"	36"	29"	63	15	\$640
☞ MCRN2442R	24"	42"	29"	67	18	\$664
☞ MCRN2448R	24"	48"	29"	74	20	\$694
☞ MCRN2454R	24"	54"	29"	80	23	\$731
☞ MCRN3048R	30"	48"	29"	89	25	\$775

Full modesty standard. ½ modesty on returns may be specified at no upcharge.
Black grommet center top and modesty. Upgrade grommet cover to silver, N/C.

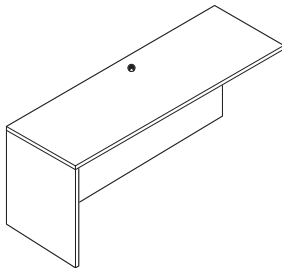

Return Shell Left (Full modesty, Flush height)

Model#	Depth	Width	Height	Weight	Cube	Price
☞ MCRN2036L	20"	36"	29"	60	13	\$514
☞ MCRN2042L	20"	42"	29"	67	15	\$529
☞ MCRN2048L	20"	48"	29"	73	17	\$579
☞ MCRN2054L	20"	54"	29"	80	19	\$626
☞ MCRN2436L	24"	36"	29"	63	15	\$640
☞ MCRN2442L	24"	42"	29"	67	18	\$664
☞ MCRN2448L	24"	48"	29"	74	20	\$694
☞ MCRN2454L	24"	54"	29"	80	23	\$731
☞ MCRN3048L	30"	48"	29"	89	25	\$775

Full modesty standard. ½ modesty on returns may be specified at no upcharge.
Black grommet center top and modesty. Upgrade grommet cover to silver, N/C.

maverick complete

Returns

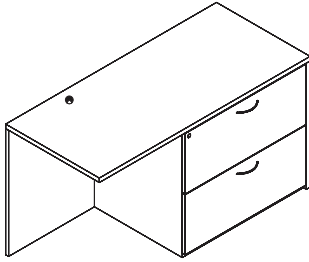

Return, Right 31" Lateral File (H3B handles, lock, full modesty)

Model#	Depth	Width	Height	Weight	Cube	Price
MCRLF2054R	20"	54"	29"	192	19	\$1,485
MCRLF2060R	20"	60"	29"	198	21	\$1,512
MCRLF2454R	24"	54"	29"	201	23	\$1,569
MCRLF2460R	24"	60"	29"	208	25	\$1,606

Upgrade to H30 Handle...\$61 list each.
Black grommet center top and modesty. Upgrade grommet cover to silver, N/C.

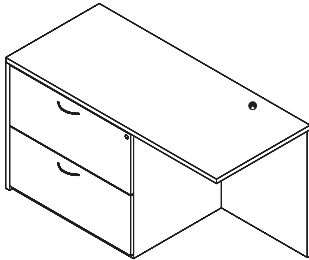

Return, Left 31" Lateral File (H3B handles, lock, full modesty)

Model#	Depth	Width	Height	Weight	Cube	Price
MCRLF2054L	20"	54"	29"	192	19	\$1,485
MCRLF2060L	20"	60"	29"	198	21	\$1,512
MCRLF2454L	24"	54"	29"	201	23	\$1,569
MCRLF2460L	24"	60"	29"	208	25	\$1,606

Upgrade to H30 Handle...\$61 list each.
Black grommet center top and modesty. Upgrade grommet cover to silver, N/C.

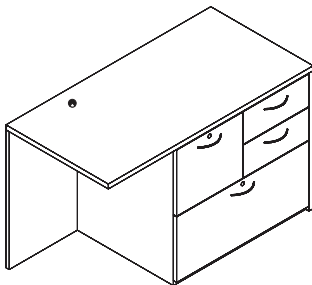

Return, Right 31" Personal Lateral File (H3B handles, locks, full modesty)

Model#	Depth	Width	Height	Weight	Cube	Price
MCRPLF2054R	20"	54"	29"	195	19	\$1,718
MCRPLF2060R	20"	60"	29"	201	23	\$1,773
MCRPLF2454R	24"	54"	29"	205	23	\$1,735
MCRPLF2460R	24"	60"	29"	213	28	\$1,807

Box drawers do not lock.
Black grommet center top and modesty. Upgrade grommet cover to silver, N/C.

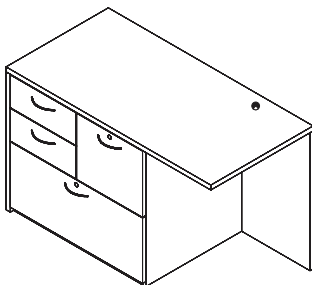

Return, Left 31" Personal Lateral File (H3B handles, locks, full modesty)

Model#	Depth	Width	Height	Weight	Cube	Price
MCRPLF2054L	20"	54"	29"	195	19	\$1,718
MCRPLF2060L	20"	60"	29"	201	23	\$1,773
MCRPLF2454L	24"	54"	29"	205	23	\$1,735
MCRPLF2460L	24"	60"	29"	213	28	\$1,807

Box drawers do not lock.
Black grommet center top and modesty. Upgrade grommet cover to silver, N/C.

NOTE: Returns with personal lateral file, when ordering with APH1 handles (1) lock is standard.

maverick complete

Credenzas

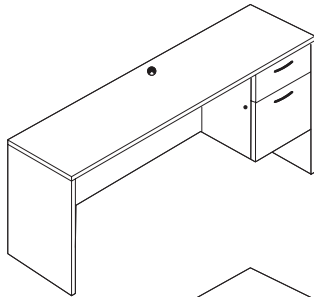

Credenza, Single Box/File Pedestal Right (Full modesty, H3B handles, lock)

Model#	Depth	Width	Height	Weight	Cube	Price
☞ MCC2060 4R	20"	60"	29"	150	21	\$1,050
☞ MCC2066 4R	20"	66"	29"	157	23	\$1,153
☞ MCC2072 4R	20"	72"	29"	164	25	\$1,169
☞ MCC2472 4R	24"	72"	29"	168	30	\$1,200

Black grommet center top and modesty. Upgrade grommet cover to silver, N/C.

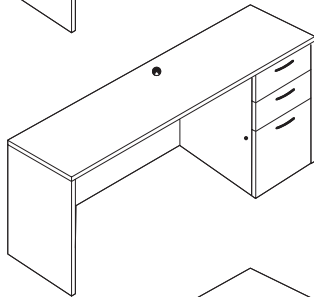

Credenza, Single Box/Box/File Pedestal Right (Full modesty, H3B handles, lock)

Model#	Depth	Width	Height	Weight	Cube	Price
☞ MCCC2060 4R	20"	60"	29"	185	21	\$1,424
☞ MCCC2066 4R	20"	66"	29"	190	23	\$1,541
☞ MCCC2072 4R	20"	72"	29"	200	25	\$1,557
☞ MCCC2472 4R	24"	72"	29"	220	30	\$1,587

Black grommet center top and modesty. Upgrade grommet cover to silver, N/C.

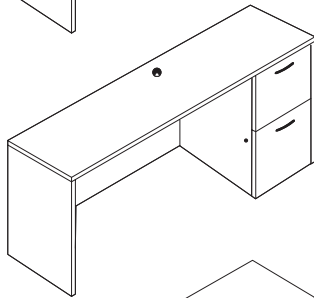

Credenza, Single File/File Pedestal Right (Full modesty, H3B handles, lock)

Model#	Depth	Width	Height	Weight	Cube	Price
☞ MCCD2060 4R	20"	60"	29"	183	21	\$1,358
☞ MCCD2066 4R	20"	66"	29"	190	23	\$1,476
☞ MCCD2072 4R	20"	72"	29"	200	25	\$1,491
☞ MCCD2472 4R	24"	72"	29"	220	30	\$1,522

Black grommet center top and modesty. Upgrade grommet cover to silver, N/C.

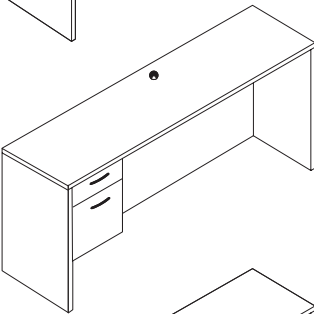

Credenza, Single Box/File Pedestal Left (Full modesty, H3B handles, lock)

Model#	Depth	Width	Height	Weight	Cube	Price
☞ MCC2060 4L	20"	60"	29"	150	21	\$1,050
☞ MCC2066 4L	20"	66"	29"	157	23	\$1,153
☞ MCC2072 4L	20"	72"	29"	164	25	\$1,169
☞ MCC2472 4L	24"	72"	29"	168	30	\$1,200

Black grommet center top and modesty. Upgrade grommet cover to silver, N/C.

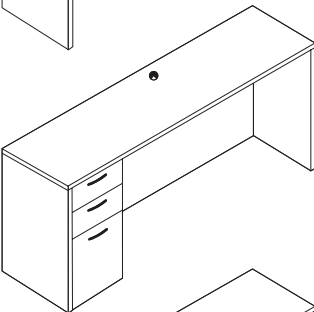

Credenza, Single Box/Box/File Pedestal Left (Full modesty, H3B handles, lock)

Model#	Depth	Width	Height	Weight	Cube	Price
☞ MCCC2060 4L	20"	60"	29"	185	21	\$1,424
☞ MCCC2066 4L	20"	66"	29"	190	23	\$1,541
☞ MCCC2072 4L	20"	72"	29"	200	25	\$1,557
☞ MCCC2472 4L	24"	72"	29"	220	30	\$1,587

Black grommet center top and modesty. Upgrade grommet cover to silver, N/C.

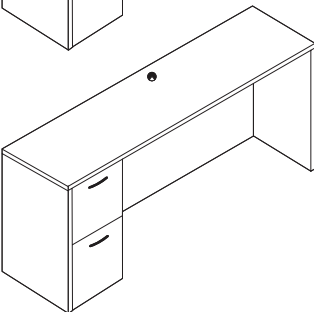

Credenza, Single File/File Pedestal Left (Full modesty, H3B handles, lock)

Model#	Depth	Width	Height	Weight	Cube	Price
☞ MCCD2060 4L	20"	60"	29"	183	21	\$1,358
☞ MCCD2066 4L	20"	66"	29"	190	23	\$1,476
☞ MCCD2072 4L	20"	72"	29"	200	25	\$1,491
☞ MCCD2472 4L	24"	72"	29"	220	30	\$1,522

Black grommet center top and modesty. Upgrade grommet cover to silver, N/C.

maverick complete

Credenzas

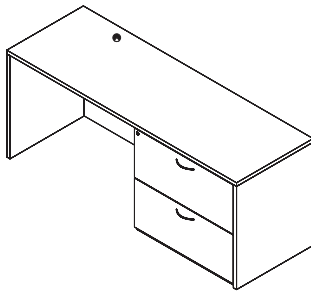

Credenza, Right 36" Lateral File Pedestal (H3B handles, lock, full modesty)

Model#	Depth	Width	Height	Weight	Cube	Price
MCC2066 5R	20"	66"	29"	223	23	\$1,627
MCC2072 5R	20"	72"	29"	230	25	\$1,642
MCC2472 5R	24"	72"	29"	270	30	\$1,716

Upgrade to H30 Handle...\$61 list each.
Black grommet center top and modesty. Upgrade grommet cover to silver, N/C.

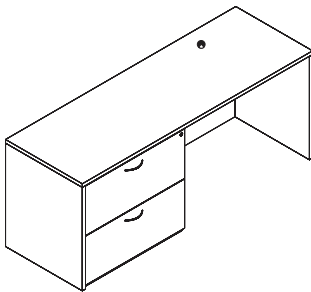

Credenza, Left 36" Lateral File Pedestal (H3B handles, lock, full modesty)

Model#	Depth	Width	Height	Weight	Cube	Price
MCC2066 5L	20"	66"	29"	223	23	\$1,627
MCC2072 5L	20"	72"	29"	230	25	\$1,642
MCC2472 5L	24"	72"	29"	270	30	\$1,716

Upgrade to H30 Handle...\$61 list each.
Black grommet center top and modesty. Upgrade grommet cover to silver, N/C.

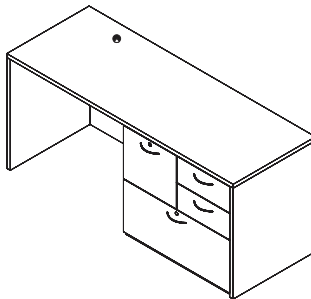

Credenza, Right 31" Personal Lateral File Pedestal (H3B handles, 2 locks, full modesty)

Model#	Depth	Width	Height	Weight	Cube	Price
MCC2066 6R	20"	66"	29"	230	26	\$1,862
MCC2072 6R	20"	72"	29"	236	28	\$1,885
MCC2472 6R	24"	72"	29"	260	30	\$1,958

Box drawers do not lock.
Black grommet center top and modesty. Upgrade grommet cover to silver, N/C.

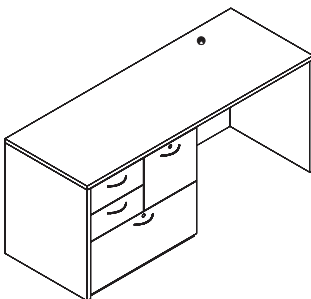

Credenza, Left 31" Personal Lateral File Pedestal (H3B handles, 2 locks, full modesty)

Model#	Depth	Width	Height	Weight	Cube	Price
MCC2066 6L	20"	66"	29"	230	26	\$1,862
MCC2072 6L	20"	72"	29"	236	28	\$1,885
MCC2472 6L	24"	72"	29"	260	30	\$1,958

Box drawers do not lock.
Black grommet center top and modesty. Upgrade grommet cover to silver, N/C.

NOTE: Returns with personal lateral file, when ordering with APH1 handles (1) lock is standard.

maverick complete

CompuCorner Credenzas

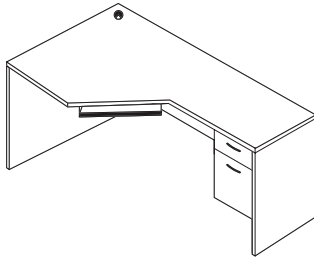

Computer Corner, Box/File Pedestal Right (H3B handles, lock, Full modesty)

Model#	(L)	(B)	(E)	(K)	(R)	(W)	Weight	Cube	Price
☞ MCCD66 4R	66"	36"	24"	21"	24"	24"	229	42	\$1,236
☞ MCCD72 3R	72"	36"	20"	24"	20"	33"	249	45	\$1,305
☞ MCCD72 4R	72"	36"	24"	21"	24"	30"	249	45	\$1,184
☞ MCCD72 7R	72"	36"	24"	23"	20"	32"	285	45	\$1,287
☞ MCCD72 8R	72"	42"	24"	24"	24"	33"	285	53	\$1,551

Keyboard tray and worksurface black grommet standard. Upgrade grommet cover to silver, N/C.

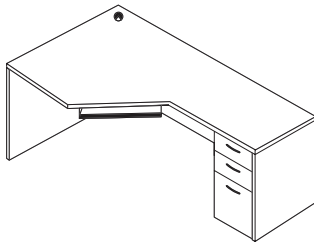

Computer Corner, Box/Box/File Pedestal Right (H3B handles, lock, Full modesty)

Model#	(L)	(B)	(E)	(K)	(R)	(W)	Weight	Cube	Price
☞ MCCD66C 4R	66"	36"	24"	21"	24"	24"	245	42	\$1,631
☞ MCCD72C 3R	72"	36"	20"	24"	20"	33"	265	45	\$1,698
☞ MCCD72C 4R	72"	36"	24"	21"	24"	30"	265	45	\$1,578
☞ MCCD72C 7R	72"	36"	24"	23"	20"	32"	300	45	\$1,683
☞ MCCD72C 8R	72"	42"	24"	24"	24"	33"	300	53	\$1,946

Keyboard tray and worksurface black grommet standard. Upgrade grommet cover to silver, N/C.

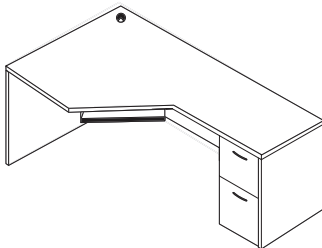

Computer Corner, File/File Pedestal Right (H3B handles, lock, Full modesty)

Model#	(L)	(B)	(E)	(K)	(R)	(W)	Weight	Cube	Price
☞ MCCD66D 4R	66"	36"	24"	21"	24"	24"	245	42	\$1,513
☞ MCCD72D 3R	72"	36"	20"	24"	20"	33"	265	45	\$1,579
☞ MCCD72D 4R	72"	36"	24"	21"	24"	30"	265	45	\$1,513
☞ MCCD72D 7R	72"	36"	24"	23"	20"	32"	300	45	\$1,617
☞ MCCD72D 8R	72"	42"	24"	24"	24"	33"	300	53	\$1,880

Keyboard tray and worksurface black grommet standard. Upgrade grommet cover to silver, N/C.

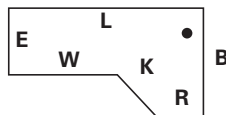

- "L" Length along approach edge
- "B" Back end panel
- "E" End panel
- "K" Keyboard space
- "R" Return size to attach
- "W" Workarea (kbrd to end)

maverick complete

CompuCorner Credenzas

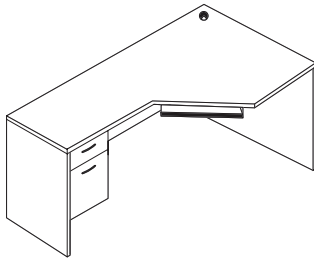

Computer Corner, Box/File Pedestal Left (H3B handles, lock, Full modesty)

Model#	(L)	(B)	(E)	(K)	(R)	(W)	Weight	Cube	Price
☞ MCCD66 4L	66"	36"	24"	21"	24"	24"	229	42	\$1,236
☞ MCCD72 3L	72"	36"	20"	24"	20"	33"	249	45	\$1,305
☞ MCCD72 4L	72"	36"	24"	21"	24"	30"	249	45	\$1,184
☞ MCCD72 7L	72"	36"	24"	23"	20"	32"	285	45	\$1,287
☞ MCCD72 8L	72"	42"	24"	24"	24"	33"	285	53	\$1,551

Keyboard tray and worksurface black grommet standard. Upgrade grommet cover to silver, N/C.

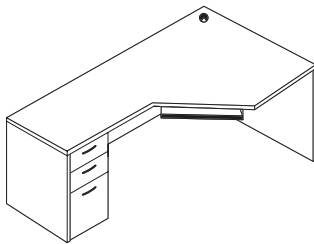

Computer Corner, Box/Box/File Pedestal Left (H3B handles, lock, Full modesty)

Model#	(L)	(B)	(E)	(K)	(R)	(W)	Weight	Cube	Price
☞ MCCD66C 4L	66"	36"	24"	21"	24"	24"	245	42	\$1,631
☞ MCCD72C 3L	72"	36"	20"	24"	20"	33"	265	45	\$1,698
☞ MCCD72C 4L	72"	36"	24"	21"	24"	30"	265	45	\$1,578
☞ MCCD72C 7L	72"	36"	24"	23"	20"	32"	300	45	\$1,683
☞ MCCD72C 8L	72"	42"	24"	24"	24"	33"	300	53	\$1,946

Keyboard tray and worksurface black grommet standard. Upgrade grommet cover to silver, N/C.

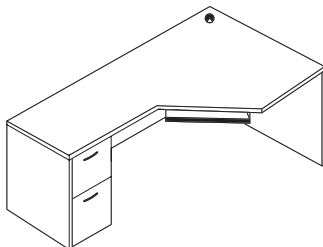

Computer Corner, File/File Pedestal Left (H3B handles, lock, Full modesty)

Model#	(L)	(B)	(E)	(K)	(R)	(W)	Weight	Cube	Price
☞ MCCD66D 4L	66"	36"	24"	21"	24"	24"	245	42	\$1,513
☞ MCCD72D 3L	72"	36"	20"	24"	20"	33"	265	45	\$1,579
☞ MCCD72D 4L	72"	36"	24"	21"	24"	30"	265	45	\$1,513
☞ MCCD72D 7L	72"	36"	24"	23"	20"	32"	300	45	\$1,617
☞ MCCD72D 8L	72"	42"	24"	24"	24"	33"	300	53	\$1,880

Keyboard tray and worksurface black grommet standard. Upgrade grommet cover to silver, N/C.

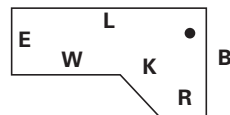

"L" Length along approach edge

"B" Back end panel

"E" End panel

"K" Keyboard space

"R" Return size to attach

"W" Workarea (kbrd to end)

maverick complete

CompuCorner Credenzas

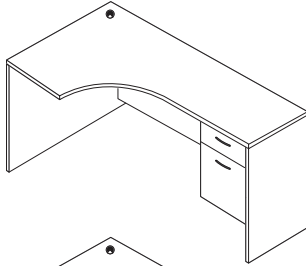

Computer Corner, Curved, 3/4 Box/File Pedestal Right (H3B handles, lock, Full modesty)

Model#	(L)	(B)	(E)	(K)	(R)	(W)	Weight	Cube	Price
MCCDQ72 4R	72"	36"	24"	21"	24"	30"	239	45	\$1,184

No keyboard tray. Worksurface black grommet standard. Upgrade grommet cover to silver, N/C.

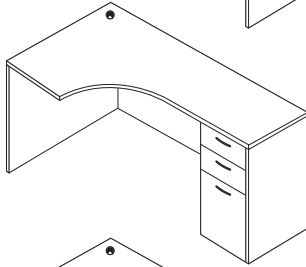

Computer Corner, Curved, Box/Box/File Pedestal Right (H3B handles, lock, Full modesty)

Model#	(L)	(B)	(E)	(K)	(R)	(W)	Weight	Cube	Price
MCCDQ72C 4R	72"	36"	24"	21"	24"	30"	254	45	\$1,578

No keyboard tray. Worksurface black grommet standard. Upgrade grommet cover to silver, N/C.

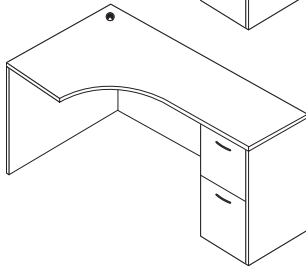

Computer Corner, Curved, File/File Pedestal Right (H3B handles, lock, Full modesty)

Model#	(L)	(B)	(E)	(K)	(R)	(W)	Weight	Cube	Price
MCCDQ72D 4R	72"	36"	24"	21"	24"	30"	254	45	\$1,514

No keyboard tray. Worksurface black grommet standard. Upgrade grommet cover to silver, N/C.

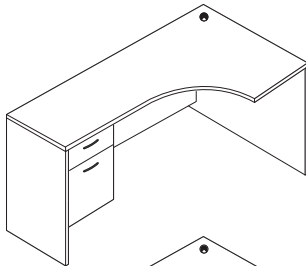

Computer Corner, Curved, 3/4 Box/File Pedestal Left (H3B handles, lock, Full modesty)

Model#	(L)	(B)	(E)	(K)	(R)	(W)	Weight	Cube	Price
MCCDQ72 4L	72"	36"	24"	21"	24"	30"	239	45	\$1,184

No keyboard tray. Worksurface black grommet standard. Upgrade grommet cover to silver, N/C.

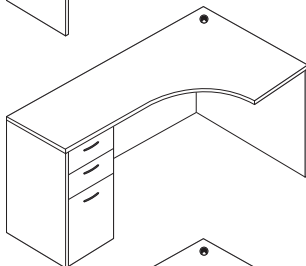

Computer Corner, Curved, Box/Box/File Pedestal Left (H3B handles, lock, Full modesty)

Model#	(L)	(B)	(E)	(K)	(R)	(W)	Weight	Cube	Price
MCCDQ72C 4L	72"	36"	24"	21"	24"	30"	254	45	\$1,578

No keyboard tray. Worksurface black grommet standard. Upgrade grommet cover to silver, N/C.

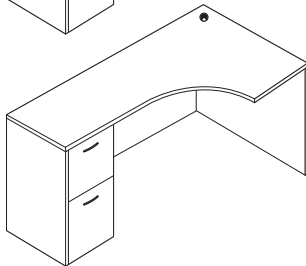

Computer Corner, Curved, File/File Pedestal Left (H3B handles, lock, Full modesty)

Model#	(L)	(B)	(E)	(K)	(R)	(W)	Weight	Cube	Price
MCCDQ72D 4L	72"	36"	24"	21"	24"	30"	254	45	\$1,514

No keyboard tray. Worksurface black grommet standard. Upgrade grommet cover to silver, N/C.



- "L" Length along approach edge
- "B" Back end panel
- "E" End panel
- "K" Keyboard space
- "R" Return size to attach
- "W" Workarea (kbrd to end)

See available accessories and upgrades, pp. 105-108.

maverick complete

CompuCorner Credenzas

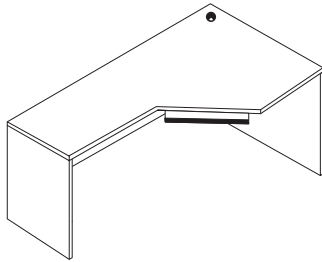

Computer Corner Shell (Full modesty), For Right Return

Model#	(L)	(B)	(E)	(K)	(R)	(W)	Weight	Cube	Price
MCCDN60 2R	60"	30"	20"	21"	20"	21"	184	32	\$ 850
MCCDN72 3R	72"	36"	20"	24"	20"	33"	213	45	\$ 986
MCCDN72 4R	72"	36"	24"	21"	24"	30"	213	45	\$1,018

Keyboard tray and worksurface black grommet standard. Upgrade grommet cover to silver, N/C.

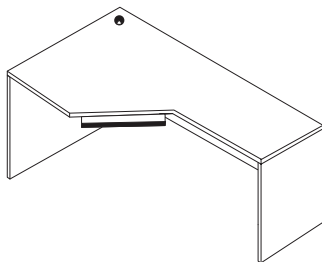

Computer Corner Shell (Full modesty), For Left Return

Model#	(L)	(B)	(E)	(K)	(R)	(W)	Weight	Cube	Price
MCCDN60 2L	60"	30"	20"	21"	20"	21"	184	32	\$ 850
MCCDN72 3L	72"	36"	20"	24"	20"	33"	213	45	\$ 986
MCCDN72 4L	72"	36"	24"	21"	24"	30"	213	45	\$1,018

Keyboard tray and worksurface black grommet standard. Upgrade grommet cover to silver, N/C.

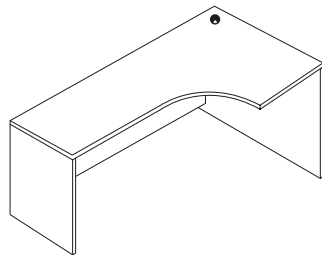

Computer Corner Shell, Curved (Full modesty), For Right Return

Model#	(L)	(B)	(E)	(K)	(R)	(W)	Weight	Cube	Price
MCCDNQ72 4R	72"	36"	24"	21"	24"	30"	213	45	\$1,018

Worksurface black grommet standard. No keyboard tray. Upgrade grommet cover to silver, N/C.

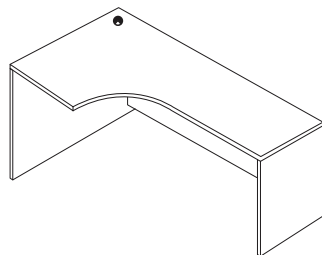

Computer Corner Shell, Curved (Full modesty), For Left Return

Model#	(L)	(B)	(E)	(K)	(R)	(W)	Weight	Cube	Price
MCCDNQ72 4L	72"	36"	24"	21"	24"	30"	213	45	\$1,018

Worksurface black grommet standard. No keyboard tray. Upgrade grommet cover to silver, N/C.

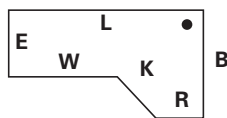

- "L" Length along approach edge
- "B" Back end panel
- "E" End panel
- "K" Keyboard space
- "R" Return size to attach
- "W" Workarea (kbrd to end)

See available accessories and upgrades, pp. 105-108.

maverick complete

CompuCorner Credenzas

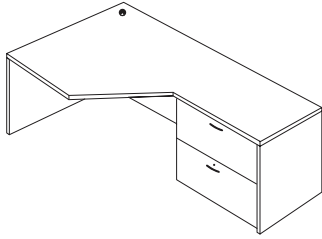

Computer Corner, Right 31" Lateral File (H3B handles, lock, full modesty)

Model#	(L)	(B)	(E)	(K)	(R)	(W)	Weight	Cube	Price
MCCD72LF 3R	72"	36"	20"	24"	20"	33"	249	45	\$1,605
MCCD72LF 4R	72"	36"	24"	21"	24"	30"	265	45	\$1,693

No keyboard tray and worksurface black grommet standard. Upgrade to H3S handles...N/C. Upgrade grommet cover to silver, N/C.

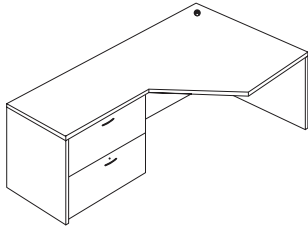

Computer Corner, Left 31" Lateral File (H3B handles, lock, full modesty)

Model#	(L)	(B)	(E)	(K)	(R)	(W)	Weight	Cube	Price
MCCD72LF 3L	72"	36"	20"	24"	20"	33"	249	45	\$1,605
MCCD72LF 4L	72"	36"	24"	21"	24"	30"	265	45	\$1,693

No keyboard tray and worksurface black grommet standard. Upgrade to H3S handles...N/C. Upgrade grommet cover to silver, N/C.

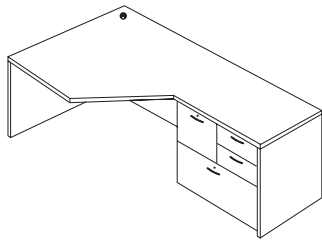

Computer Corner, Right 31" Personal Lateral File (H3B handles, locks, full modesty)

Model#	(L)	(B)	(E)	(K)	(R)	(W)	Weight	Cube	Price
MCCD72PLF 3R	72"	36"	20"	24"	20"	33"	249	45	\$1,803
MCCD72PLF 4R	72"	36"	24"	21"	24"	30"	265	45	\$1,849

No keyboard tray and worksurface black grommet standard. Box drawers do not lock. Upgrade to H3S handles...N/C. Upgrade grommet cover to silver, N/C.

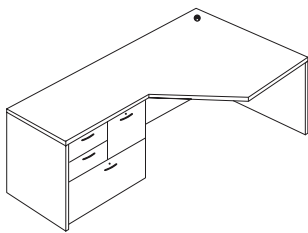

Computer Corner, Left 31" Personal Lateral File (H3B handles, locks, full modesty)

Model#	(L)	(B)	(E)	(K)	(R)	(W)	Weight	Cube	Price
MCCD72PLF 3L	72"	36"	20"	24"	20"	33"	249	45	\$1,803
MCCD72PLF 4L	72"	36"	24"	21"	24"	30"	265	45	\$1,849

No keyboard tray and worksurface black grommet standard. Box drawers do not lock. Upgrade to H3S handles...N/C. Upgrade grommet cover to silver, N/C.

NOTE: Returns with personal lateral file, when ordering with APH1 handles (1) lock is standard.

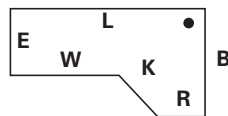

- "L" Length along approach edge
- "B" Back end panel
- "E" End panel
- "K" Keyboard space
- "R" Return size to attach
- "W" Workarea (kbrd to end)

See available accessories and upgrades, pp. 105-108.

maverick complete

Credenzas

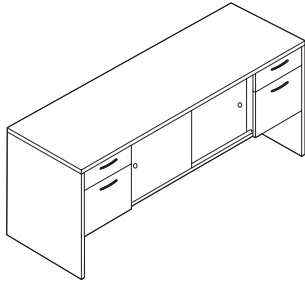

Credenza, Double Pedestal, Box/File Left and Right, Center Storage
(Sliding doors, Full modesty, H3B handles, 2 locks)

Model#	Depth	Width	Height	Weight	Cube	Price
MCC2060 2	20"	60"	29"	230	21	\$1,266
MCC2066 2	20"	66"	29"	240	23	\$1,467
MCC2072 2	20"	72"	29"	250	25	\$1,482
MCC2472 2	24"	72"	29"	270	30	\$1,565

Storage includes one adjustable ¾"-thick shelf.
NOTE: Ped lock is inside doors.

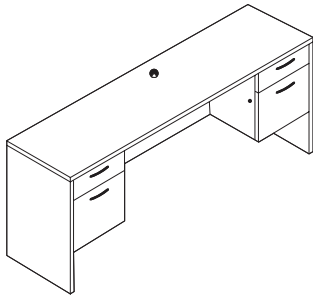

Credenza, Double Pedestal, Box/File Left and Right
(Knee space, Full modesty, H3B handles, 2 locks)

Model#	Depth	Width	Height	Weight	Cube	Price
MCC2060 3	20"	60"	29"	196	21	\$1,272
MCC2066 3	20"	66"	29"	205	23	\$1,484
MCC2072 3	20"	72"	29"	210	25	\$1,506
MCC2472 3	24"	72"	29"	230	30	\$1,541

Black grommet center top and modesty. Upgrade grommet cover to silver, N/C.

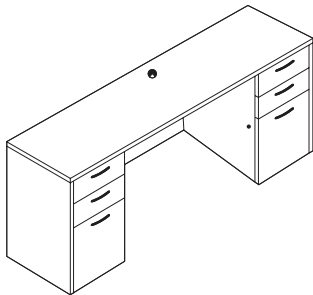

Credenza, Double Pedestal, Box/Box/File Left and Right
(Knee space, full modesty, H3B handles, 2 locks)

Model#	Depth	Width	Height	Weight	Cube	Price
MCCC2060 3	20"	60"	29"	245	21	\$1,780
MCCC2066 3	20"	66"	29"	255	23	\$1,991
MCCC2072 3	20"	72"	29"	265	25	\$2,012
MCCC2472 3	24"	72"	29"	290	30	\$2,048

Black grommet center top and modesty. Upgrade grommet cover to silver, N/C.

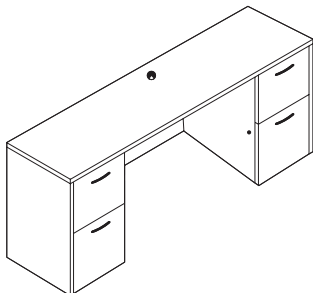

Credenza, Double Pedestal, File/File Left and Right
(Knee space, full modesty, H3B handles, 2 locks)

Model#	Depth	Width	Height	Weight	Cube	Price
MCCD2060 3	20"	60"	29"	245	21	\$1,690
MCCD2066 3	20"	66"	29"	255	23	\$1,902
MCCD2072 3	20"	72"	29"	265	25	\$1,924
MCCD2472 3	24"	72"	29"	290	30	\$1,959

Black grommet center top and modesty. Upgrade grommet cover to silver, N/C.

maverick complete

Credenzas

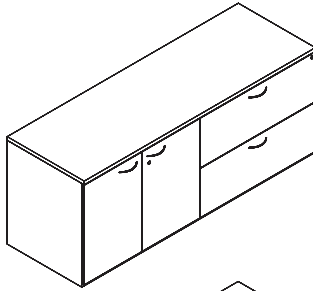

Credenza, Hinged Door Cabinet Left and Lateral File Right (H3B handles, 2 locks)

Model#	Depth	Width	Height	Weight	Cube	Price
MCC2072 9FP	20"	72"	29"	270	30	\$1,985
MCC2472 9FP	24"	72"	29"	290	30	\$2,036

Cabinet includes 1 adjustable shelf $\frac{3}{4}$ " thick.

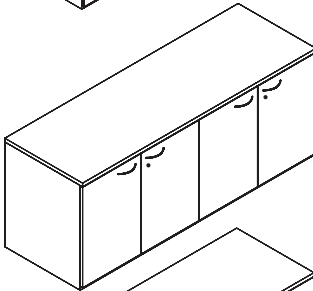

Credenza, Full Storage (4 full hinged doors, 2 adjustable shelves, H3B handles, 2 locks)

Model#	Depth	Width	Height	Weight	Cube	Price
MCC2048 1FP	20"	48"	29"	155	17	\$1,682
MCC2448 1FP	24"	48"	29"	175	20	\$1,757
MCC2060 1FP	20"	60"	29"	220	21	\$1,785
MCC2066 1FP	20"	66"	29"	240	23	\$1,921
MCC2072 1FP	20"	72"	29"	260	25	\$1,942
MCC2472 1FP	24"	72"	29"	295	30	\$2,092
MCC207236 1FP	20"	72"	36"	238	30	\$2,087
MCC247236 1FP	24"	72"	36"	265	36	\$2,187

Storage includes 1 adjustable shelf $\frac{3}{4}$ " thick per side.

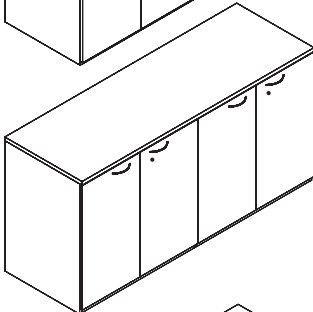

Credenza Buffet, 4 box drawers, 4 full hinged doors (H3B handles, 2 locks doors only)

Model#	Depth	Width	Height	Weight	Cube	Price
MCHDBC2036	20"	36"	36"	220	15	\$1,400
MCHDBC2436	24"	36"	36"	240	18	\$1,513
MCHDBC2060	20"	60"	36"	236	25	\$2,613
MCHDBC2460	24"	60"	36"	261	30	\$2,708
MCHDBC2072	20"	72"	36"	260	30	\$2,625
MCHDBC2472	24"	72"	36"	290	36	\$2,728

Storage includes 1 adjustable shelf $\frac{3}{4}$ " thick per side.

36"W credenza: 2 box drawers, 2 hinged doors, 1 adjustable shelf, 1 lock.

Optional face locks available for box drawers, add MM FL...\$78 each.

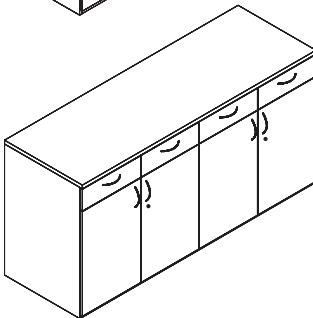

Credenza Buffet, 4 box drawers, 4 hinged glass doors (H3B handles)

Model#	Depth	Width	Height	Weight	Cube	Price
MMHDBC2036G	20"	36"	36"	220	15	\$1,498
MMHDBC2436G	24"	36"	36"	240	18	\$1,606
MCHDBC2072G	20"	72"	36"	240	18	\$3,328
MCHDBC2472G	24"	72"	36"	290	36	\$3,429

Storage includes 1 adjustable shelf $\frac{3}{4}$ " thick per side.

36"W credenza: 2 box drawers & 2 glass doors, 1 adjustable shelf.

Optional face locks available for box drawers, add MM FL...\$78 each. Locks N/A for glass doors.

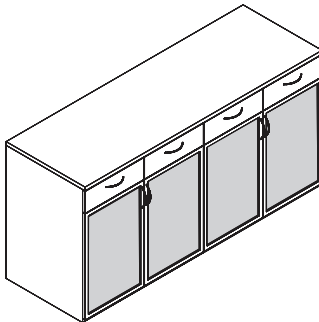

maverick complete

Hutches

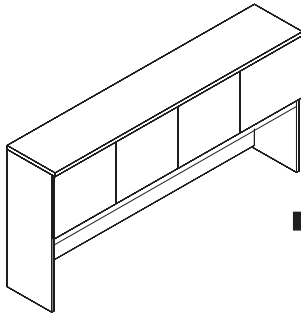

Hutch with Doors and Fascia (18" below Fascia)

Model#	Depth	Width	Height	# Doors	Weight	Cube	Price
☞ MCH48 WD	14"	48"	36"	4	130	14	\$1,153
☞ MCH60 WD	14"	60"	36"	4	155	18	\$1,236
☞ MCH66 WD	14"	66"	36"	4	167	20	\$1,333
☞ MCH72 WD	14"	72"	36"	4	179	21	\$1,364
☞ Glass Doors MCH72 WG	14"	72"	36"	4	179	21	\$1,884

Optional face locks (2 locks required), add MM FL...\$78 each. Glass doors do NOT lock.
 May be upgraded to 42" height, add MM UHH...\$176. Add tasklights and tackboards, see p. 97.
 Ends are 3/4" thick; doors overlay legs but are inset to the 1"-thick top.

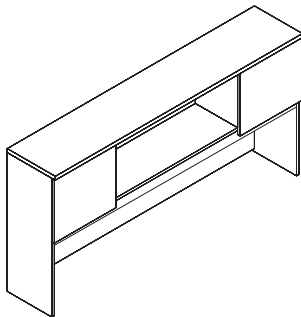

Hutch with Fascia, Left and Right Door, Center Opening (18" below Fascia)

Model#	Depth	Width	Height	# Doors	Weight	Cube	Price
MCH60 W2D	14"	60"	36"	2	140	18	\$1,130
MCH66 W2D	14"	66"	36"	2	152	20	\$1,185
MCH72 W2D	14"	72"	36"	2	164	21	\$1,236

Optional face locks (2 locks required), add MM FL...\$78 each. Doors are same width as open space.
 May be upgraded to 42" height, add MM UHH...\$176. Add tasklights and tackboards, see p. 97.
 Ends are 3/4" thick; doors overlay legs but are inset to the 1"-thick top.

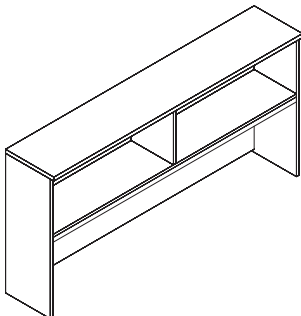

Hutch with Fascia, No Doors (18" below Fascia)

Model#	Depth	Width	Height	Weight	Cube	Price
☞ MCH48 ND	14"	48"	36"	115	14	\$ 869
☞ MCH60 ND	14"	60"	36"	135	18	\$ 899
☞ MCH66 ND	14"	66"	36"	148	20	\$ 968
☞ MCH72 ND	14"	72"	36"	160	21	\$1,056

May be upgraded to 42" height, add MM UHH...\$176. Add tasklights, fascia and tackboards, see p. 97.
 Ends are 3/4" thick; doors overlay legs but are inset to the 1"-thick top.

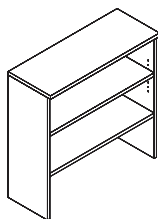

Bookcase Hutch, Full Back Panel

(One adjustable shelf, One fixed shelf, 1"-thick shelves) Bottom Clearance 12"H

Model#	Depth	Width	Height#	Shelves	Weight	Cube	Price
☞ MCBCH31	14"	31"	36"	2	72	11	\$430
☞ MCBCH	14"	36"	36"	2	72	11	\$450

May be upgraded to 42" height, add MMUHH...\$176. 12"H Bottom clearance does not change. See p. 97.
 Ends are 3/4" thick; legs are inset to the 1"-thick top. Width coordinates with lateral files and utility cabinets.

maverick complete

Wall Mount Cabinets

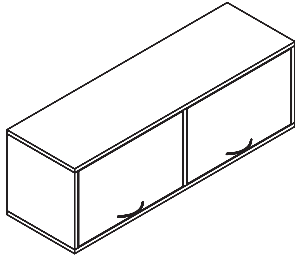

Wall Mount Overhead Cabinet With Flip Doors, H3B handles
(35lb. weight capacity)

Model#	Depth	Width	Height	# of Doors	Weight	Cube	Price
MCCFOHB30	14 3/4"	30"	16"	1	110	7	\$ 920
MCCFOHB36	14 3/4"	36"	16"	1	110	7	\$1,039
MCCFOHB48	14 3/4"	48"	16"	2	110	7	\$1,238

Optional locks (two required on 48"W), add MMFL...\$78 each.
Requires professional installation and must be mounted to wall stud.
35lb. weight capacity.

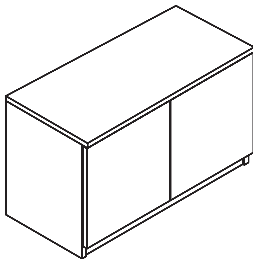

Wall Mount Overhead Cabinet with Hinged Door Overlay, Finger pull, Fascia
(35lb. weight capacity)

Model#	Depth	Width	Height	# of Doors	Weight	Cube	Price
MCCFOHD30	14 3/4"	30"	18 1/2"	2	110	7	\$789
MCCFOHD36	14 3/4"	36"	18 1/2"	2	110	7	\$812
MCCFOHD42	14 3/4"	42"	18 1/2"	2	120	9	\$932
MCCFOHD48	14 3/4"	48"	18 1/2"	4	120	9	\$960

* Wall mount overhead storage includes fascia. Optional handles may be added.
Optional face lock (two required on 42"W and 48"W) MMFL add...\$78 each.
Requires professional installation and must be mounted to wall stud.
35lb. weight capacity.

Storage

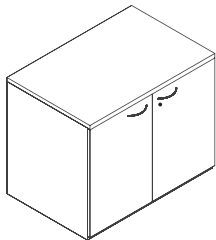

Glass Doors

Hinged Door Utility Cabinet (H3B handle, one 3/4"-thick adjustable shelf, lock)

Model#	Depth	Width	Height	Weight	Cube	Price
MCHDC2036	20"	36"	29"	115	13	\$ 888
MCHDC2042	20"	42"	29"	165	15	\$ 935
MCHDC2436	24"	36"	29"	175	15	\$1,009
MCHDC2442	24"	42"	29"	180	18	\$1,084
MCHDC2436G	24"	36"	29"	175	18	\$1,328

Width coordinates with bookcase hutch. Glass doors do NOT lock.

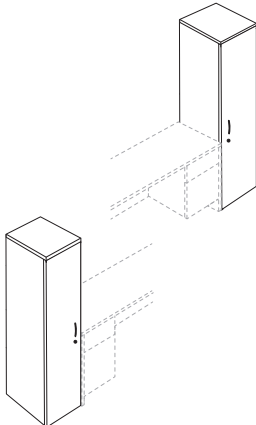

Single Storage Cabinet, Right (H3B handle, three adjustable 3/4"-thick shelves, lock)

Model#	Depth	Width	Height	Weight	Cube	Price
MCSTS1665R	20"	16"	65"	185	12	\$1,072

Upgrade to H30 Handle...\$61 list each.

Single Storage Cabinet, Left (H3B handle, three adjustable 3/4"-thick shelves, lock)

Model#	Depth	Width	Height	Weight	Cube	Price
MCSTS1665L	20"	16"	65"	185	12	\$1,072

Upgrade to H30 Handle...\$61 list each.

maverick complete

Storage

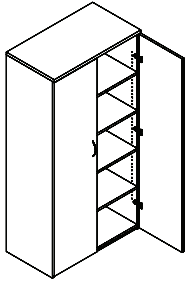

Double Storage Cabinet (H3B handles, 3/4"-thick adjustable shelves, lock)

Model#	Depth	Width	Height	# Shelves	Weight	Cube	Price
MCST3642	20"	36"	42"	2	208	18	\$1,243
MCST3665	20"	36"	65"	3	290	27	\$1,436
MCST3672	20"	36"	72"	4	370	30	\$1,622
MCST243665	24"	36"	65"	3	290	27	\$1,786
MCST243672	24"	36"	72"	4	370	30	\$1,961

Upgrade to H30 Handle...\$61 list each.

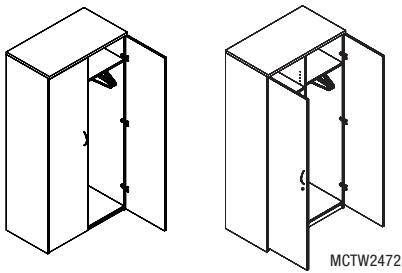

Wardrobe Cabinet (H3B handles, coat rack, one fixed shelf, 1-lock)

Model#	Depth	Width	Height	Weight	Cube	Price
MCWC3665	24"	36"	65"	309	33	\$1,436
MCWC3672	24"	36"	72"	325	36	\$1,622
MCTW2472	24"	36"	72"	286	36	\$2,124

MCTW2472 Includes: Left 4-adjustable shelves, right wardrobe, 2 locks.
Upgrade to H30 Handle...\$61 list each.

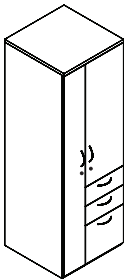

Personal Storage Cabinet 2 doors and Box/Box/File Pedestal, 2 adjustable shelves (H3B handles, 3 face locks)

Model#	Depth	Width	Height	Weight	Cube	Price
MCWCP2465	24"	24"	65"	309	22	\$2,296
MCWCP2472	24"	24"	72"	325	24	\$2,459

Coat rack in long compartment. Both doors face lock, pedestal face lock.

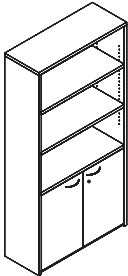

Bookcase with Storage Cabinet (H3B handles, lock, 1"-thick adjustable shelves)

Model#	Depth	Width	Height	# Shelves	Weight	Cube	Price
MCBCD3660	14"	36"	60"	2	135	18	\$1,287
MCBCD3672	14"	36"	72"	3	145	21	\$1,331
MCBCD3684	14"	36"	84"	4	155	25	\$1,518

See available accessories and upgrades, pp. 105-108.

maverick complete

Storage

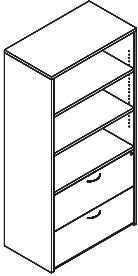

Bookcase with 36" Wide Lateral File (H3B handles, 1"-thick adjustable shelves, lock)

Model#	Depth	Width	Height	# Shelves	Weight	Cube	Price
MCBCLF3660	20"	36 1/2"	60"	1	224	25	\$1,643
MCBCLF3672	20"	36 1/2"	72"	2	260	30	\$1,726
MCBCLF3684	20"	36 1/2"	84"	3	281	35	\$1,896

Upgrade to H30 Handle...\$61 list each.

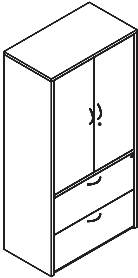

Bookcase with 36" Wide Lateral File & Doors (H3B handles, 1"-thick adjustable shelves, 2 locks)

Model#	Depth	Width	Height	# Shelves	Weight	Cube	Price
MCBCLF3672WD	20"	36 1/2"	72"	2	300	30	\$2,187
MCBCLF3684WD	20"	36 1/2"	84"	3	331	35	\$2,425

Upgrade to H30 Handle...\$61 list each.

Bookcases

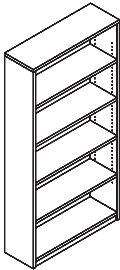

Bookcase (1"-thick adjustable shelves)

Model#	Depth	Width	Height	# Shelves	Weight	Cube	Price
☞ MCBC3630	12"	36"	29"	1	61	18	\$435
☞ MCBC3648	12"	36"	48"	2	86	12	\$584
☞ MCBC3660	12"	36"	60"	3	107	15	\$704
☞ MCBC3665	12"	36"	65"	3	111	17	\$734
☞ MCBC3672	12"	36"	72"	4	128	18	\$762
☞ MCBC3684	12"	36"	84"	5	137	21	\$951

For additional adjustable shelf, add MMSH1 \$113 ea.

maverick complete

Files

(All drawers are 16"D except vertical files)

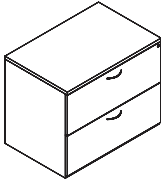

2-Drawer Lateral File (H3B handles, anti-tip interlock)

Model#	Depth	Width	Height	Weight	Cube	Price
MCLF2031	20"	31"	29"	135	11	\$ 938
MCLF2431	24"	31"	29"	147	13	\$ 964
☞ MCLF202	20"	36"	29"	160	13	\$1,088
☞ MCLF242	24"	36"	29"	176	15	\$1,133

Upgrade to H30 Handle...\$61 each.

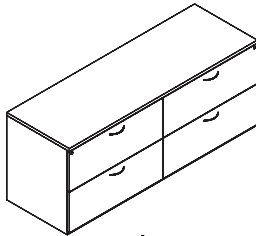

4-Drawer Double Lateral File (H3B handles, 2 anti-tip interlock)

Model#	Depth	Width	Height	Weight	Cube	Price
MCLF202+2	20"	72"	29"	330	25	\$1,997
MCLF242+2	24"	72"	29"	335	30	\$2,082

Upgrade to H30 Handle...\$61 each.

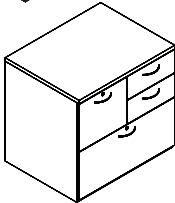

Personal Lateral File 31" W (H3B handles, 2 locks)

Model#	Depth	Width	Height	Weight	Cube	Price
MCPLF20	20"	31"	29"	189	11	\$1,114
MCPLF24	24"	31"	29"	205	13	\$1,166

Box drawers do not lock. If ordered APH1 handles (1) lock is standard.

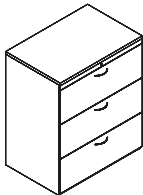

3-Drawer Lateral File (H3B handles, lock) Anti-Tip Interlock

Model#	Depth	Width	Height	Weight	Cube	Price
2⊗ MCLF203	20"	36"	43"	240	18	\$1,706
2⊗ MCLF243	24"	36"	43"	264	22	\$1,774

REQUIRES 2⊗ LEAD TIME. Upgrade to H30 handles...\$61 each.

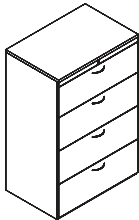

4-Drawer Lateral File (H3B handles, lock) Anti-Tip Interlock

Model#	Depth	Width	Height	Weight	Cube	Price
2⊗ MCLF204	20"	36"	55"	330	23	\$2,184
2⊗ MCLF244	24"	36"	55"	335	28	\$2,282

REQUIRES 2⊗ LEAD TIME. Upgrade to H30 handles...\$61 each.

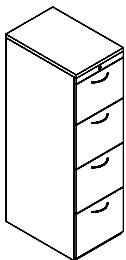

MCVF4

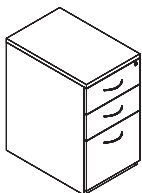

MCVFC

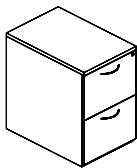

MCVF2

Vertical Files (H3B handles, lock)

Model#	Depth	Width	Height	20"D Drawers	Weight	Cube	Price
☞ MCVF2	24"	16"	29"	2	160	7	\$ 775
☞ MCVFC	24"	16"	29"	3	160	7	\$ 852
MCVF2LGL	24"	19"	29"	2	172	8	\$ 872
2⊗ MCVF4	24"	16"	55"	4	180	7	\$1,619
2⊗ MCVF4LGL	24"	19"	55"	4	190	8	\$1,750

4 Drawer vertical files require 2⊗ LEAD TIME.
Anti-tip interlock is standard on 4-drawer vertical files only.

See available accessories and upgrades, pp. 105-108.

maverick complete

Pedestals - Freestanding

NOTE: Pedestals below cannot be used for Apex series.
Contact us for quote

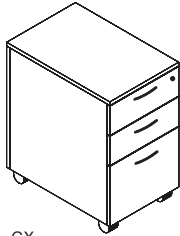

CX

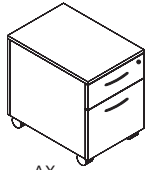

AX

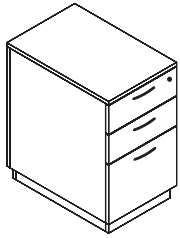

CM

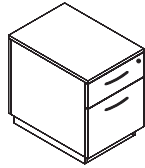

AM

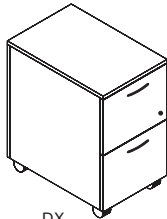

DX

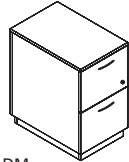

DM

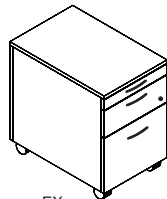

EX

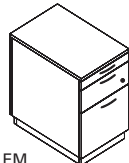

EM

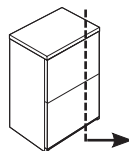

Mobile Pedestal, Box/Box/File or Box/File with Casters (Fully finished, letter size)

Model#	Depth	Width	Height	Drawer Depth	Weight	Cube	Price
MCPED AX	23"	16"	22"	20	56	5	\$696
MCPED AX20	19"	16"	22"	16	56	5	\$685
MCPED CX	23"	16"	27 5/8"	20	90	6	\$831
MCPED CX20	19"	16"	27 5/8"	16	80	6	\$815

Pedestal, Box/Box/File or Box File with Kickbase (Fully finished, letter size, 2 1/2"H kickbase)

Model#	Depth	Width	Height	Drawer Depth	Weight	Cube	Price
MCPED AM	23"	16"	22"	20	50	4	\$696
MCPED AM20	19"	16"	22"	16	50	4	\$685
MCPED CM	23"	16"	27 5/8"	20	90	6	\$831
MCPED CM20	19"	16"	27 5/8"	16	80	6	\$815

One convenience tray (MM BPT) and 1 file bar is provided.

Mobile Pedestal, File/File with Casters (Fully finished, letter size)

Model#	Depth	Width	Height	Drawer Depth	Weight	Cube	Price
MCPED DX	23"	16"	27 5/8"	20	90	6	\$806
MCPED DX20	19"	16"	27 5/8"	16	80	6	\$780

Pedestal, File/File with Kickbase (Fully finished, letter size, 2 1/2"H kickbase)

Model#	Depth	Width	Height	Drawer Depth	Weight	Cube	Price
MCPED DM	23"	16"	27 5/8"	20	90	6	\$806
MCPED DM20	19"	16"	27 5/8"	16	80	6	\$780

2 file bars are provided.

Mobile Pedestal, Pencil/Box/File with Casters (Fully finished, letter size)

Model#	Depth	Width	Height	Drawer Depth	Weight	Cube	Price
MCPED EX	23"	16"	24"	20	90	6	\$831
MCPED EX20	19"	16"	24"	16	80	6	\$790

Pedestal, Pencil/Box/File with Kickbase (Fully finished, letter size, 2 1/2"H kickbase)

Model#	Depth	Width	Height	Drawer Depth	Weight	Cube	Price
MCPED EM	23"	16"	24"	20	90	6	\$806
MCPED EM20	19"	16"	24"	16	80	6	\$790

Locks box/file only. 1 file bar provided.

Upgrade Pedestals from Standard Width to Legal Width

Model#	Depth	Width	Height	Weight	Cube	Price
MM UPEDLGL	no change	19"	no change	128	8	\$99

Depth and height does not change. Option to upgrade is available for all pedestals above.

See available accessories and upgrades, pp. 105-108.

maverick complete

Upgrades and Accessories for Hutches

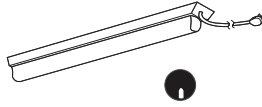

Tasklight (Black, one light only) One Grommet on Hutch Back Panel

Model#	Depth	Width	Height	Weight	Cube	Price
MC TSKLTX	7 7/8"	24 1/2"	1 7/8"	2	.1	\$241

72" hutch takes 2 lights. For extra tasklight add MMTSKLT \$192.

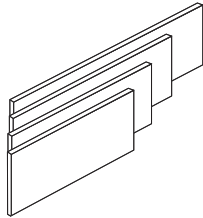

Hutch Tackboards

Model#	Depth	Width	Height	Hutch Width	Weight	Cube	Price
MM TKBD30	1"	28"	14 1/4"	36"	9	.5	\$389
MM TKBD36	1"	34"	14 1/4"	42"	9	.5	\$405
MM TKBD42	1"	40"	14 1/4"	48"	12	.6	\$418
MM TKBD48	1"	46"	14 1/4"	54"	12	.6	\$450
MM TKBD54	1"	52"	14 1/4"	60"	15	.7	\$480
MM TKBD60	1"	58"	14 1/4"	66"	17	.8	\$509
MM TKBD66	1"	64"	14 1/4"	72"	19	1	\$545
MM TKBD72	1"	70"	14 1/4"	78"	21	1	\$665
MM TKBD78 (2 pcs)	1"	76"	14 1/4"	84"	23	1	\$740

For COM fabric add \$30/Sq. yd. Required yardage to be provided by customer.
78" width is made in 2 pieces.
For fabric color choice, see inside back cover. For Underground Fabric add 25%

Fabric Chart (Uses Guilford of Maine)

STANDARD FABRICS

Tempest 2120...Zebra 015, Silk 045 **Sprite 2671...**Snow 7040, Linen 7010

Anchorage 2335...Sunshine 2082, Waterfall 2691, Green Apple 2087, Aubergine 2036, Goose 2049, Onyx 2016, Red Delicious 2014

Metro 3077...Storefront 030, Skyscraper 022 **Cape Cod 3073...**Linen 7031, Surf 7062

Metallation 5118...Chrome 1676, Polished Pewter 1678

Cadence 5595...Jade 1441, Turquoise 1442, Opal 1432, Sapphire 1443, Coral 1437

25% UPCHARGE*

* **Underground 2967...**Champagne 010, Tangerine 070, Azure 050, Ocean 041, Pepper 030, Earth 061

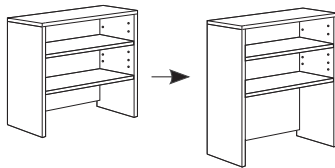

Upgrade Hutch Height from 36"H to 42"H

Model#	Price
MM UHH	\$176

Hutches: Doors or shelves do not change, bottom clearance increases by 6".
Bookcase hutch: 12"H bottom clearance does not change.

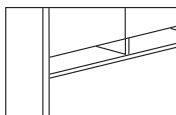

Hutch Mail Slots (Paper manager) (Decreases clearance under shelf by 5")

Model#	Depth	Width	Height	Weight	Cube	Price
MM HMS	12"	varies	4 3/4"	varies	varies	\$227

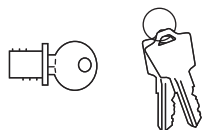

Face Lock for Hutch Doors

Model#	Depth	Width	Height	Weight	Cube	Price
MM FL						\$78

1 per set of 2 doors. Hutch with 4 doors takes 2 locks. Glass doors do NOT lock.

maverick complete

Upgrades and Accessories

STANDARD HANDLE OPTIONS



Crescent Black
(MM H3B)



Crescent Silver
(MM H3S)



Elliptical Black
(MM H5B)



Elliptical Silver
(MM H5S)



Crescent Textured Nickel
(MM H6)



Flared Nickel
(MM H7)



Bow Handle
(MM H8)



Curved Handle
(MM H9)



Bar Square Handle
(MM H10)



Bar Handle
(MM H14)

GROMMETS



Grommet

Model#	Color	Depth	Width	Surface Hole Diameter	Price
MM GR234B	Black Plastic	3"	3"	2 3/4"	\$49
MM GR234S	Silver Plastic	3"	3"	2 3/4"	\$49

Grommet Color, Upgrade from Standard Black to Silver

Model#	Color	Depth	Width	Surface Hole Diameter	Price
MM UGR234S	Silver Plastic	3"	3"	2 3/4"	No Charge

GROMMETS LOCATION (WORKSURFACE AND MODESTY)

NOTE: While sitting at unit, grommet locations named from left to right.
For grommet location on tops and/or modesty panel specify left, center or right.
No grommets over pedestals.

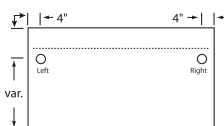

Desks

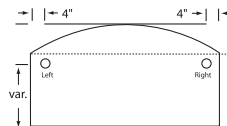

Desks

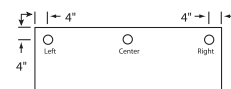

Credenza, Return,
Bridges

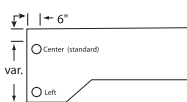

CompuCredenza

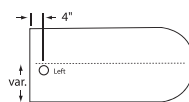

Bullets

Statement of Line

RECEPTION



Reception - Single Ped
Single ped, desk only transaction
(RCAS)

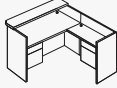

Reception - "L" Shape
Desk transaction counter only
(RCAX)

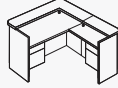

Reception - "L" Shape
Transaction counter on desk & return
(RCAL)

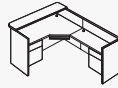

Reception - "L" Shape Computer
Desk transaction counter only
(RCDX)

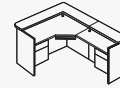

Reception - "L" Shape Computer
Transaction counter on desk & return
(RCDL)



Reception - Double Ped
Desk transaction Counter
(RCAD)

NOTES:

- Before ordering, ensure that the building and room access, including elevators, will accommodate furniture of this size. Use of pin-and-cam construction does facilitate some disassembly.
- Details of front transaction counter vary by series as do pedestals.
- Handles and locks standards vary by series.

How to Order Reception Units

WORKSURFACE UNITS: RECEPTION UNITS

1. Product number: **MC** **RCAL** **36** **72** **L**

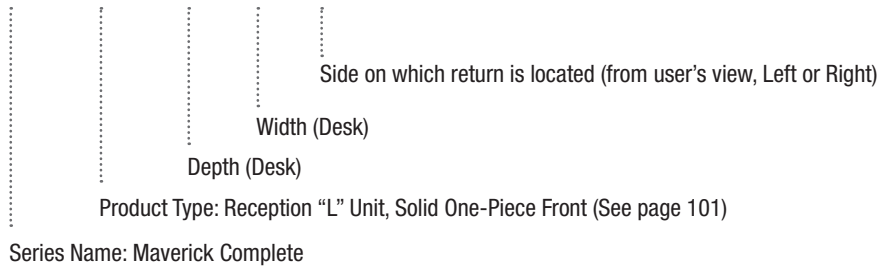

2. Specify worksurface finish. See back cover.
3. Specify worksurface edge trim finish. Matching color edge is standard. See back cover.
4. Specify chassis finish. Matching color edge trim is standard. See back cover.
5. Specify handle options. H3B is standard if none specified.
6. Specify other accessories and upgrade options. See pages 104-108.

HANDLE OPTIONS



Crescent Black
(MM H3B)



Crescent Silver
(MM H3S)



Elliptical Black
(MM H5B)



Elliptical Silver
(MM H5S)



Crescent Textured Nickel
(MM H6)



Flared Nickel
(MM H7)



Bow Handle
(MM H8)



Curved Handle
(MM H9)



Bar Square Handle
(MM H10)



Bar Handle
(MM H14)



GROGNET

Black grogmet standard where shown. Upgrade to silver color, N/C.

maverick complete

Risers

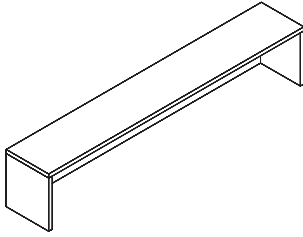

Riser (No approach overhang)

Model#	Depth	Width	Height	Weight	Cube	Price
MMRB36	12"	36"	14"	38	1	\$356
MMRB42	12"	42"	14"	43	2	\$371
MMRB48	12"	48"	14"	47	5	\$400
MMRB60	12"	60"	14"	56	6	\$574
MMRB66	12"	66"	14"	61	7	\$650
MMRB72	12"	72"	14"	65	7	\$725

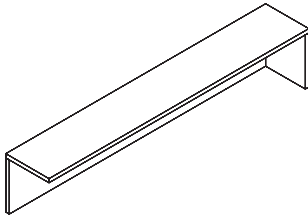

Riser Return, Right (No approach overhang)

Model#	Depth	Width	Height	Weight	Cube	Price
MMRBR36R	12"	36"	14"	32	1	\$356
MMRBR42R	12"	42"	14"	37	2	\$371
MMRBR48R	12"	48"	14"	42	5	\$400
MMRBR54R	12"	54"	14"	47	6	\$485
MMRBR60R	12"	60"	14"	51	6	\$574
MMRBR66R	12"	66"	14"	56	7	\$650
MMRBR72R	12"	72"	14"	60	7	\$725

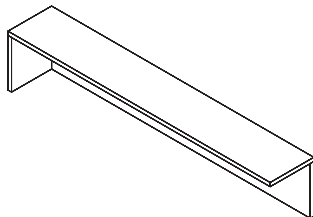

Riser Return, Left (No approach overhang)

Model#	Depth	Width	Height	Weight	Cube	Price
MMRBR36L	12"	36"	14"	32	1	\$356
MMRBR42L	12"	42"	14"	37	2	\$371
MMRBR48L	12"	48"	14"	42	5	\$400
MMRBR54L	12"	54"	14"	47	6	\$485
MMRBR60L	12"	60"	14"	51	6	\$574
MMRBR66L	12"	66"	14"	56	7	\$650
MMRBR72L	12"	72"	14"	60	7	\$725

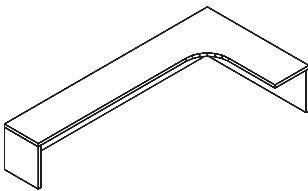

Riser "L" Shape, Right Return (12" deep, one-piece counter top)

Model#	Depth	Width	Height	Weight	Cube	Price
MMRBL3072R	30"	72"	14"	88	18	\$ 931
MMRBL3672R	36"	72"	14"	92	21	\$1,060

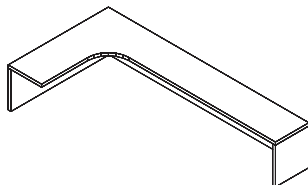

Riser "L" Shape, Left Return (12" deep, one-piece counter top)

Model#	Depth	Width	Height	Weight	Cube	Price
MMRBL3072L	30"	72"	14"	88	18	\$ 931
MMRBL3672L	36"	72"	14"	92	21	\$1,060

Notes on standard woodgrain directions:

- The front on the bridge or return unit will display the woodgrain running horizontally for 66" or larger
- On other vertical surfaces, the woodgrain runs vertically
- Worksurface woodgrain on bridge for desk runs left-to-right
- The return countertop grain direction coordinates with the desk surface, running from user's side-to-approach side except on 66" to 72" returns

Reception Units - L-Shapes (Desk and Return with Transaction Counters)

NOTE: Before ordering, ensure that the building and room access, including elevators, will accommodate furniture of this size. Use of pin-and-cam construction does facilitate some reassembly. Upgrade to Full Pedestals, See page 103.

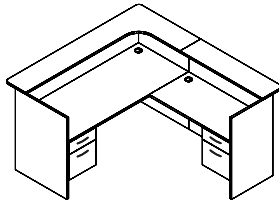

Reception "L" Unit, Solid One-Piece Front, Right Return 24" x 48"
(2 locks, H3B handles, 2 grommets)

Model#	Depth	Width	Height	Weight	Cube	Price
*MRCAL3060R	72"	66"	42"	400	92	\$3,144
MRCAL3072R	84"	78"	42"	435	104	\$3,362
MRCAL3672R	90"	78"	42"	439	115	\$3,488
MRCAL3684R	90"	90"	42"	522	127	\$3,781

Counter top is 12" deep. Counter top approach overhang is 6". Worksurface black grommets standard. Fan top on approach side of desk counter may be specified at no upcharge, insert F before C (e.g. MCRFCAL3060R). Transaction counter to desktop clearance is 11 3/4". Upgrade grommet cover to silver, N/C.
*MRCAL3060R comes with a 20"x36" right return.

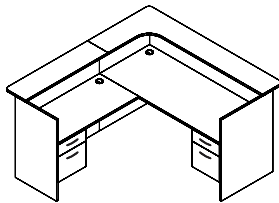

Reception "L" Unit, Solid One-Piece Front, Left Return 24" x 48"
(2 locks, H3B handles, 2 grommets)

Model#	Depth	Width	Height	Weight	Cube	Price
*MRCAL3060L	72"	66"	42"	400	92	\$3,144
MRCAL3072L	84"	78"	42"	435	104	\$3,362
MRCAL3672L	90"	78"	42"	439	115	\$3,488
MRCAL3684L	90"	90"	42"	522	127	\$3,781

Counter top is 12" deep. Counter top approach overhang is 6". Worksurface black grommets standard. Fan top on approach side of desk counter may be specified at no upcharge, insert F before C (e.g. MCRFCAL3060L). Transaction counter to desktop clearance is 11 3/4". Upgrade grommet cover to silver, N/C.
*MRCAL3060L comes with a 20"x36" left return.

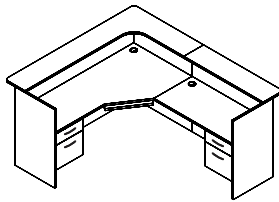

Computer Reception "L" Unit, Solid One-Piece Front, Right Return 24" x 48"
(2 locks, H3B handles, 2 grommets)

Model#	Depth	Width	Height	Weight	Cube	Price
MRCSDL3672R	90"	78"	42"	435	88	\$3,488

Counter top is 12" deep. Counter top approach overhang is 6". Worksurface black grommets and keyboard tray standard. Fan top to approach side of desk counter may be specified at no upcharge, insert F before C (e.g. MCRFCSDL3672R). Transaction counter to desktop clearance is 11 3/4". Upgrade grommet cover to silver, N/C.

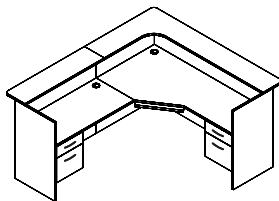

Computer Reception "L" Unit, Solid One-Piece Front, Left Return 24" x 48"
(2 locks, H3B handles, 2 grommets)

Model#	Depth	Width	Height	Weight	Cube	Price
MRCSDL3672L	90"	78"	42"	435	88	\$3,488

Counter top is 12" deep. Counter top approach overhang is 6". Worksurface black grommets and keyboard tray standard. Fan top to approach side of desk counter may be specified at no upcharge, insert F before C (e.g. MMRFCSDL3672L). Transaction counter to desktop clearance is 11 3/4". Upgrade grommet cover to silver, N/C.

Notes on standard woodgrain directions:

- The one-piece vertical front on the desk of the unit will display the woodgrain running horizontally (except 60")
- On other vertical surfaces, the woodgrain runs vertically
- Worksurface woodgrain on desk runs left-to-right
- The return worksurface grain direction coordinates with the desk surface, running from user's side to the approach side
- Transaction counter woodgrain runs the same direction as the worksurface woodgrain

maverick complete

Reception Units - L-Shapes and Reception Desks (Desk-Only Transaction Counter)

NOTE: Before ordering, ensure that the building and room access, including elevators, will accommodate furniture of this size. Use of pin-and-cam construction does facilitate some reassembly. Upgrade to Full Pedestals, See P.103.

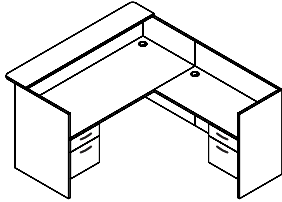

Reception "L" Unit, Solid One-Piece Front, Right Return 24" x 48"*
(Desk counter only, 2 locks, H3B handles, 2 grommets)

Model#	Depth	Width	Height	Weight	Cube	Price
MCRCA3060R*	72"	60"	42"	390	92	\$2,843
MCRCA3072R	84"	72"	42"	425	92	\$3,014
MCRCA3672R	90"	72"	42"	430	92	\$3,337

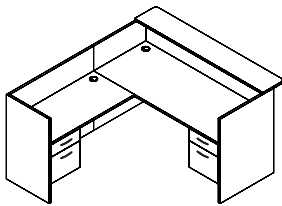

Reception "L" Unit, Solid One-Piece Front, Left Return 24" x 48"*
(Desk counter only, 2 locks, H3B handles, 2 grommets)

Model#	Depth	Width	Height	Weight	Cube	Price
MCRCA3060L*	72"	60"	42"	390	92	\$2,843
MCRCA3072L	84"	72"	42"	425	92	\$3,014
MCRCA3672L	90"	72"	42"	430	92	\$3,337

Counter top is 12" deep. Counter top approach overhang is 6". Worksurface black grommets standard. Fan top on approach side of desk counter may be specified at no upcharge, insert F before C (e.g. MMRFCAX3060R) Transaction counter to desktop clearance is 11 3/4". *MMRCA3060 comes with a 20" x 36" return. Upgrade grommet cover to silver, N/C.

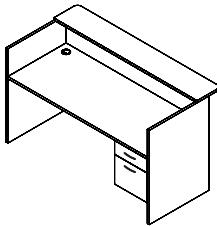

Reception Single Pedestal Desk, BF Right
(Desk counter only, lock, H3B handles, left grommet)

Model#	Depth	Width	Height	Weight	Cube	Price
MRCAS3060R	36"	60"	42"	232	53	\$1,938
MRCAS3072R	36"	72"	42"	250	63	\$2,066

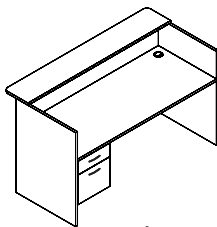

Reception Single Pedestal Desk, BF Left
(Desk counter only, lock, H3B handles, right grommet)

Model#	Depth	Width	Height	Weight	Cube	Price
MRCAS3060L	36"	60"	42"	232	53	\$1,938
MRCAS3072L	36"	72"	42"	250	63	\$2,066

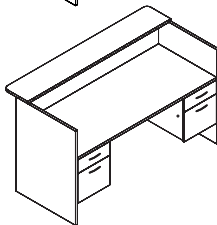

Reception Double Pedestal Desk, Left & Right BF (Desk counter only, no grommet)

Model#	Depth	Width	Height	Weight	Cube	Price
MRCAD3072	36"	72"	42"	250	63	\$2,380

Counter top is 12" deep. Counter top approach overhang is 6". Worksurface black grommets standard. Fan top on approach side of desk counter may be specified at no upcharge, insert F before C (e.g. MMRFCAS3060R) Transaction counter to desktop clearance is 11 3/4". Upgrade grommet cover to silver, N/C.

Notes on standard woodgrain directions:

- The one-piece vertical front on the desk of the unit will display the woodgrain running horizontally (except 60")
- On other vertical surfaces, the woodgrain runs vertically
- Worksurface woodgrain on desk runs left-to-right
- The return worksurface grain direction coordinates with the desk surface, running from user's side to the approach side
- Transaction counter woodgrain runs the same direction as the worksurface woodgrain

Reception Units - Computer L-Shapes Desks and Return (Desk-Only Transaction Counter)

NOTE: Before ordering, ensure that the building and room access, including elevators, will accommodate furniture of this size. Use of pin-and-cam construction does facilitate some reassembly. Upgrade to Full Pedestals, See below.

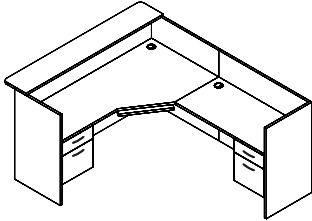

Computer Reception "L" Unit, Solid One-Piece Front, Right Return 24" x 48"
(2 locks, H3B handles, 2 grommets)

Model#	Depth	Width	Height	Weight	Cube	Price
MCRCDX3672R	90"	72"	42"	425	88	\$3,123

Counter top is 12" deep. Counter top approach overhang is 6". Worksurface black grommets and keyboard tray standard. Fan top on approach side of desk counter may be specified at no upcharge, insert F before C (e.g. MCRFCDX3672R). Desk counter only. Transaction counter-to-desktop clearance is 11 3/4". Upgrade grommet cover to silver, N/C.

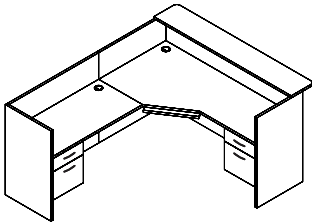

Computer Reception "L" Unit, Solid One-Piece Front, Left Return 24" x 48"
(2 locks, H3B handles, 2 grommets)

Model#	Depth	Width	Height	Weight	Cube	Price
MCRCDX3672L	90"	72"	42"	425	88	\$3,123

Counter top is 12" deep. Counter top approach overhang is 6". Worksurface black grommets and keyboard tray standard. Fan top on approach side of desk counter may be specified at no upcharge, insert F before C (e.g. MCRFCDX3672L). Desk counter only. Transaction counter-to-desktop clearance is 11 3/4". Upgrade grommet cover to silver, N/C.

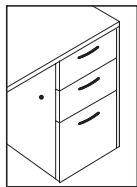

MCUPEDC

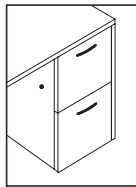

MCUPEDD

Upgrade to Full Pedestals (Pedestal upgrade for receptions only)

Model#	Depth	Width	Height	Weight	Cube	Price
MCUPEDC	19"	15 3/4"	25 3/16"	75	6	\$299 ea.
	(Upgrade from BF to BBF)					
MCUPEDD	19"	15 3/4"	25 3/16"	75	6	\$257 ea.
	(Upgrade from BF to BBF)					

Notes on standard woodgrain directions:

- The one-piece vertical front on the desk of the unit will display the woodgrain running horizontally (except 60")
- On other vertical surfaces, the woodgrain runs vertically
- Worksurface woodgrain on desk runs left-to-right
- The return worksurface grain direction coordinates with the desk surface, running from user's side to the approach side
- Transaction counter woodgrain runs the same direction as the worksurface woodgrain

maverick complete

STANDARD HANDLE OPTIONS FOR RECEPTION UNITS



Crescent Black
(MM H3B)



Crescent Silver
(MM H3S)



Elliptical Black
(MM H5B)



Elliptical Silver
(MM H5S)



Crescent Textured Nickel
(MM H6)



Flared Nickel
(MM H7)



Bow Handle
(MM H8)



Curved Handle
(MM H9)



Bar Square Handle
(MM H10)



Bar Handle
(MM H14)

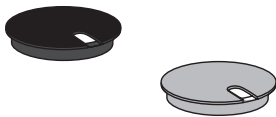

Upgrade Grommet Color from Standard Black to Silver

Model#	Color	Depth	Width	Surface Hole Diameter	Price
MM UGR234	Silver Plastic	3"	3"	2 3/4"	No Charge

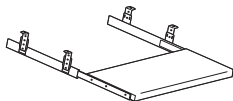

Keyboard Tray, Rollout (Specify laminate color)

Model#	Depth	Width	Height	Weight	Cube	Price
MM KB	16"	21"	3"	10	.5	\$135

maverick complete

Accessories

Specify standard handle selection no charge, H3B-H10 & H14.
For H11, H30 and APH1 handles charges apply, see below



Crescent Handle, Metal - Black or Silver Finish

Model#	Hole Center	Width	Color	Price
☞ MM H3B	5"	5 3/4"	Black	N/C
☞ MM H3S	5"	5 3/4"	Silver	N/C

Elliptical Handle, Metal - Black or Silver Finish

Model#	Hole Center	Width	Color	Price
☞ MM H5B	5"	6 3/4"	Black	N/C
☞ MM H5S	5"	6 3/4"	Silver	N/C

Crescent Textured Nickel Handle, Metal - Silver Finish

Model#	Hole Center	Width	Price
☞ MM H6	5"	6 1/4"	N/C

Flared Nickel Handle, Metal - Silver Finish

Model#	Hole Center	Width	Price
☞ MM H7	5"	6 1/4"	N/C

Bow Handle, Silver Finish

Model#	Hole Center	Width	Price
☞ MM H8	5"	6 1/8"	N/C

Curved Handle, Silver Finish

Model#	Hole Center	Width	Price
☞ MM H9	5"	6 1/2"	N/C

Bar Square Handle, Silver Finish

Model#	Hole Center	Width	Price
☞ MM H10	5"	5 3/8"	N/C
MM H11	11"	11 3/8"	\$61/ea.

MM H11 handles full upgrade charges apply.

Bar Handle, Silver Finish

Model#	Hole Center	Width	Price
☞ MM H14	11"	14"	N/C
MM H30*	27"	30"	\$61/ea.

MM H30* handles DO NOT fit on pedestal drawers or hutch doors. Full upgrade charges apply for MM H30.

Curved Edge Handle, Brushed Aluminum Finish

Model#	Hole Center	Width	Price
APH1	1 5/8"	7 7/8"	\$55/ea.

Extends ☞ lead time. Full upgrade charges apply.
When ordering APH1 handles for personal lateral files (1) lock is standard, locks file and lateral file only.

maverick complete

Accessories and Upgrades

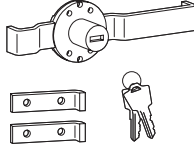

Pedestal Lock (Mounted on side of pedestal)

Model#	Description	Price
MM PL	Side pedestal lock	\$78

For **freestanding pedestals**, specify left or right side pedestal lock installation. Lock numbers are randomly assigned, key alike must be specify. No charge.

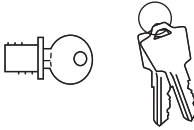

Face Lock

Model#	Description	Price
MM FL	Face lock for TFM doors or center drawers	\$ 78
MM FFL	Full face lock for pedestals	\$156

MMFL: 1 per set of 2 doors. Hutch with 4 doors requires 2 locks.
MMFLL: For B/F, F/F & BBF Pedestals.
Lock numbers are randomly assigned, key alike must be specify. No charge.

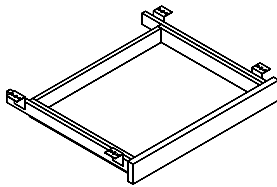

Center Drawer (9-ply birch wood drawer interior, specify front laminate color)

Model#	Depth	Width	Height	Weight	Cube	Price
MM CD	16"	21"	2 1/2"	12	.5	\$148



Box Drawer Convenience Tray, Black (Insets to box drawer)

Model#	Depth	Width	Height	Weight	Cube	Price
MM BPT	5 1/2"	12"	1"	1	.5	\$28

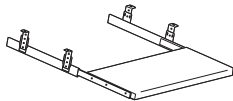

Keyboard Tray, Rollout (Specify laminate color)

Model#	Depth	Width	Height	Weight	Cube	Price
MM KB	16"	21"	3"	10	.5	\$135

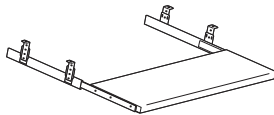

Oversize Keyboard Tray, Rollout (Specify laminate color)

Model#	Depth	Width	Height	Weight	Cube	Price
MM KBLG	16"	28"	3"	12	.5	\$199

maverick complete

Accessories and Upgrades

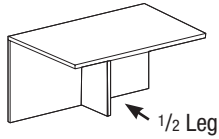

Half-Leg Support with Leveler (Add to long pieces for support)

Model#	Depth	Width	Height	Weight	Cube	Price
MM SPT	12"	1"	28"	11	3	\$113

Support leg can also be used to create freestanding returns. Specify location left or right 1/2 leg.

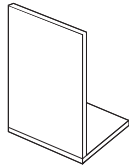

CPU Section (CPU1 for 3/4" Height Ped, CPU2 for Full Height Ped)

Model#	Depth	Width	Height	Weight	Cube	Price
MM CPU1	16"	10"	18 3/4"	15	2	\$113
MM CPU2	16"	10"	27 5/8"	18	3	\$142

Specify left or right mount. Add to desk, return or credenza.

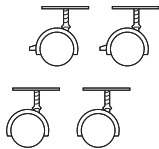

Casters, Set of Four (Two locking, two non-locking. For stands & HDC only)

Model#	Height	Price
MM CAS	2 1/2"	\$99

Height increases by 2 1/2" H.

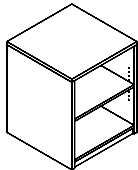

Printer Stand (Adjustable shelf, two back openings)

Model#	Depth	Width	Height	Weight	Cube	Price
MM PS2424	24"	24"	29"	65	10	\$579

For casters, add MMCAS \$99. Increases Height by 2 1/2" H.

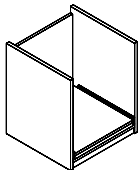

Printer Shelf with Roll-Out Shelf (Add to desk, return or credenza, each)

Model#	Depth	Width	Height	Weight	Cube	Price
MM PSS	22"	24"	28"	53	10	\$375

Rollout shelf is installed 1" clear from bottom.

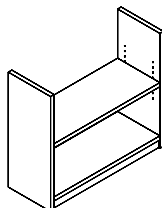

Bookcase Section (One adjustable shelf. Add to bridge or return shell)

Model#	Depth	Width	Height	Weight	Cube	Price
MM BCS	12"	32"	28"	varies	varies	\$261

No back panel.

maverick complete

Accessories and Upgrades



Additional Adjustable Shelf for Bookcases (1"-thick standard, with shelf pins)

Model#	Depth	Width	Height	Weight	Cube	Price
MM SH1	11 1/16"	33 3/4"	1"	13	.5	\$113

Fits standard bookcases.

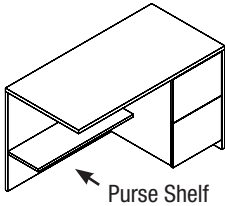

Purse Shelf (Add to desk, return or credenza)

Model#	Depth	Width	Height	Weight	Cube	Price
MM PS	10"	varies	3/4"	varies	varies	\$113

Standard Cuts and Reprogramming Charges (Extends lead time)

Model#	Maverick Series Only	Price
MM CUT1	Height or Width or Depth, 90° Cut on 90° Pieces	\$ 99
MM CUT2	Two Dimensions, 90° Cuts on 90° Pieces	\$155
MM CUT3	Program Charge	\$155

For Maverick Complete cut charges items only.

Cut Charges

HPL Tops, with Standard Color 2MM Edge Band (Maverick standard colors only. Extends lead time)

Model#	Standard Maverick Colors	Price
MM HPLM	Matte High Pressure Laminate Top Only, 2MM Edge Band	15%
MM HPLG	Gloss High Pressure Laminate Top Only, 2MM Edge Band	25%

For custom HPL color laminates, please submit quote.
Maverick does not guarantee delamination from sun exposure.

High Pressure Laminate

Cartoning Charges (Extends leadtime)

Model#	Price	
MM CAR4	Pallet Cartoning (Corner & edge protectors w/bubble/shrink wrap, place in carton, strap to pallet)	25%

Carton