

training tables

 3 Days and  Lead Time

Product Specifications

- 1" thick tops only, 2mm PVC edge-banding, pilot holes for post leg brackets only and metal inserts for ganging brackets.
- Maverick Series has radiused corners, Arroyo Series has square corners.
- Available in 20 standard colors, see color chart for upcharge information. Two colors may be specified at no charge.
- No up-charge for contrasting color edge-banding.
- Legs and ganging hardware are ordered separately from the tops and are not factory installed.
- All training and height adjustable tables can be assembled upon request at no charge.
- Tops are predrill for leg/base where specified on leg/base style items.

How to Order Training Tables

WORKSURFACE UNITS

1. Product number: **MM TR 24 60**

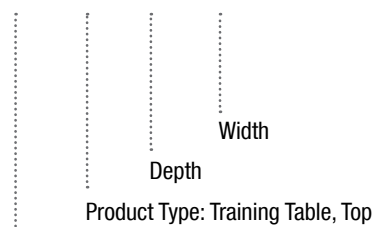

- Specify worksurface color - Choose from 20 standard colors.
- Specify edge-banding color - Matching top color is standard.
- Specify other accessories and upgrades. Grommet options page 164 see grommet locations below.
- Legs are ordered separately. Specify from available legs on page 161-163.
- Ganging and connecting hardware is ordered separately. See page 164.

MAVERICK SERIES (MM)

EDGE PROFILE-RADIUS

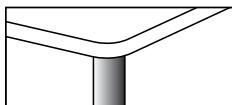

2MM FLAT PVC EDGE BANDING ON TOPS

ARROYO SERIES (AR)

EDGE PROFILE-SQUARE

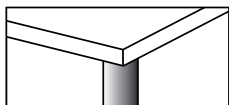

2MM FLAT PVC EDGE BANDING ON TOPS

GROMMET OPTIONS

BLACK AND SILVER



TRAINING TABLE TOP STANDARD GROMMET LOCATIONS (Unless otherwise specified)

Note: While sitting at unit, grommet locations are named from left to right. Line drawings shown below are standard locations.

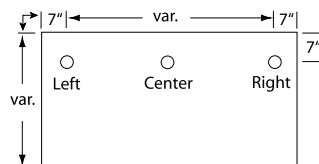

Rectangular
24" or 30"

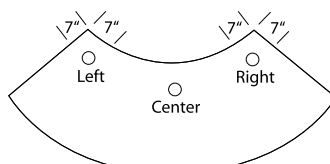

Curved
24" or 30"

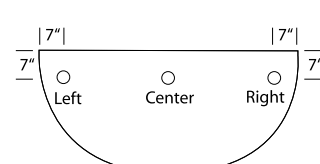

Half-Round
48" or 60"

Training Worksurfaces

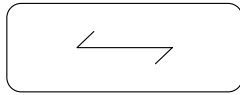
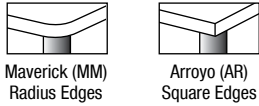

Maverick

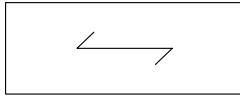

Arroyo

Rectangular Training Table Top, 20"D Tops (MM-radius edges, AR-square edges)

Model#	Depth	Width	Height	Weight	Cube	MM Price	AR Price
__TR2036	20"	36"	1"	23	1	\$250	\$223
__TR2042	20"	42"	1"	27	1	\$255	\$229
__TR2048	20"	48"	1"	30	1	\$268	\$242
__TR2054	20"	54"	1"	34	1	\$283	\$256
__TR2060	20"	60"	1"	38	1	\$324	\$291
__TR2066	20"	66"	1"	42	1	\$343	\$310
__TR2072*	20"	72"	1"	45	1	\$370	\$337
__TR2078*	20"	78"	1"	49	1	\$425	\$384
__TR2084*	20"	84"	1"	53	1	\$465	\$418

Note: When ordering, insert MM for Maverick Series or AR for Arroyo Series. Wood grain runs the width direction.

*Tops: 72"W, 78"W & 84"W require 5-Post Legs.

Stabilizer Bar: 2 are included with 60"W, 66"W & 72"W tops, when ordered with post legs.

Max weight 50 lbs.

Pre Drill Holes: Tops are pre-drill for 4-Post Legs MMLEGTRB – MMLEGTRSC.

Ganging Hardware: Is recommended when placing tops side by side.  Lead Time.

Rectangular Training Table Top, 24"D Tops (MM-radius edges, AR-square edges)

Model#	Depth	Width	Height	Weight	Cube	MM Price	AR Price
__TR2436	24"	36"	1"	30	1	\$337	\$304
__TR2442	24"	42"	1"	32	1	\$349	\$315
__TR2448	24"	48"	1"	36	1	\$364	\$332
__TR2454	24"	54"	1"	40	1	\$378	\$343
__TR2460	24"	60"	1"	45	1	\$390	\$349
__TR2466	24"	66"	1"	50	1	\$411	\$370
__TR2472*	24"	72"	1"	54	1	\$425	\$384
__TR2478*	24"	78"	1"	59	1	\$465	\$418
__TR2484*	24"	84"	1"	63	1	\$492	\$444

Note: When ordering, insert MM for Maverick Series or AR for Arroyo Series. Wood grain runs the width direction.

*Tops: 72"W, 78"W & 84"W require 5-Post Legs.

Stabilizer Bar: 2 are included with 60"W, 66"W & 72"W tops, when ordered with post legs.

Max weight 50 lbs.

Pre Drill Holes: Tops are pre-drill for 4-Post Legs MMLEGTRB – MMLEGTRSC.

Ganging Hardware: Is recommended when placing tops side by side.  Lead Time.

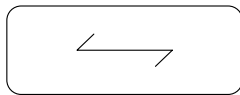

Maverick

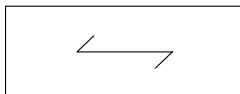

Arroyo

Rectangular Training Table Top, 30"D Tops (MM-radius edges, AR-square edges)

Model#	Depth	Width	Height	Weight	Cube	MM Price	AR Price
__TR3048	30"	48"	1"	45	1	\$349	\$315
__TR3054	30"	54"	1"	51	1	\$357	\$324
__TR3060	30"	60"	1"	57	1	\$391	\$349
__TR3066	30"	66"	1"	62	1	\$432	\$391
__TR3072*	30"	72"	1"	68	2	\$471	\$425
__TR3078*	30"	78"	1"	74	2	\$537	\$484
__TR3084*	30"	84"	1"	79	2	\$594	\$538

Note: When ordering, insert MM for Maverick Series or AR for Arroyo Series. Wood grain runs the width direction.

*Tops: 72"W, 78"W & 84"W require 5-Post Legs.

Stabilizer Bar: 2 are included with 60"W, 66"W & 72"W tops, when ordered with post legs.

Max weight 50 lbs.

Pre Drill Holes: Tops are pre-drill for 4-Post Legs MMLEGTRB – MMLEGTRSC.

Ganging Hardware: Is recommended when placing tops side by side.  Lead Time.

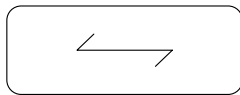

Maverick

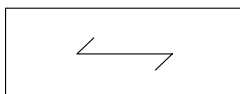

Arroyo

Training Worksurfaces

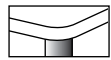

Maverick (MM)
Radius Edges

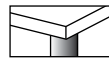

Arroyo (AR)
Square Edges

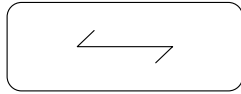

Maverick

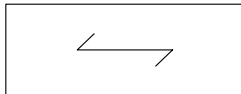

Arroyo

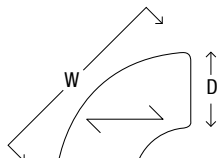

Maverick

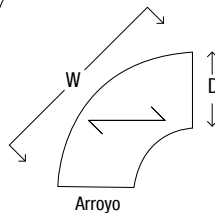

Arroyo

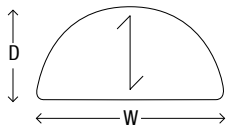

Maverick

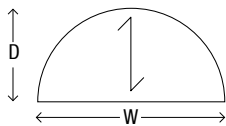

Arroyo



WG24 & WG30

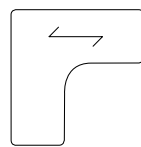
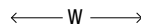

Maverick

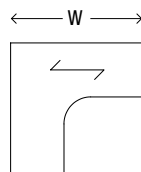

Arroyo

Rectangular Training Table Top, 36"D Tops (MM-radius edges, AR-square edges)

Model#	Depth	Width	Height	Weight	Cube	MM Price	AR Price
__TR3660	36"	60"	1"	68	1	\$518	\$471
__TR3666	36"	66"	1"	75	1	\$560	\$505
__TR3672*	36"	72"	1"	81	2	\$587	\$532

Note: When ordering, insert MM for Maverick Series or AR for Arroyo Series. Wood grain runs the width direction.
Top: 72"W requires 5-post legs.

Stabilizer Bar: 2 are included with 60"W, 66"W & 72"W tops, when ordered with post legs.
Max weight 50 lbs.

Pre Drill Holes: Tops are pre-drill for 4-Post Legs MMLEGTRB – MMLEGTRSC.

Ganging Hardware: Is recommended when placing tops side by side.  Lead Time.

Curved Training Table Top (Must be ganged with another top for stability)

Model#	Depth	Width	Height	Weight	Cube	MM Price	AR Price
__TRQ2460L	24"	60"	1"	27	1	\$398	\$359
__TRQ2460R	24"	60"	1"	27	1	\$398	\$359
__TRQ3060L	30"	60"	1"	33	2	\$440	\$398
__TRQ3060R	30"	60"	1"	33	2	\$440	\$398

Note: When ordering, insert MM for Maverick Series or AR for Arroyo before model number.
On "L" units, from users' view, woodgrain direction is parallel with right edge and perpendicular with left edge.
On "R" units wood-grain is parallel with the left edge and perpendicular with the right edge.
If not ganged, order 5th leg for stability.

Pre Drill Holes: Tops are pre-drill for Post Legs MMLEGTRB – MMLEGTRSC.

Ganging Hardware: Is recommended when placing tops side by side.  Lead Time.

Half-Round Training Table Top (48" & 60" require four legs and two ganging plates)

Model#	Depth	Width	Height	Weight	Cube	MM Price	AR Price
__TRWH1224	12"	24"	1"	6	1	\$199	\$158
__TRWH1224WG24	12"	24"	1"	6	1	\$199	\$158
__TRWH1530	15"	30"	1"	10	1	\$241	\$200
__TRWH1530WG30	15"	30"	1"	10	1	\$241	\$200
__TRWH2448	24"	48"	1"	24	1	\$502	\$461
__TRWH3060	30"	60"	1"	37	1	\$600	\$461

Note: When ordering, insert MM for Maverick Series or AR for Arroyo before model number.
Woodgrain direction runs the depth to coordinate with woodgrain direction on rectangular worksurfaces.
12" & 15" deep require only 1 leg and 1 ganging plate.

12" & 15" deep (WG24 & WG30), the woodgrain runs the width to coordinate with the grain on 1 end of curved units.

Pre Drill Holes: Tops are pre-drill for Post Legs MMLEGTRB – MMLEGTRSC.

Ganging Hardware: Is recommended when placing tops side by side.  Lead Time.

Curved Corner Training Table Top (48" & 60" require four legs and two ganging plates)

Model#	Depth	Width	Height	Weight	Cube	MM Price	AR Price
__TRCWS424224	24"	42"/ 42"	1"	24	1	\$517	\$461
__TRCWS424230	30"	42"/ 42"	1"	24	1	\$517	\$461
__TRCWS484824	24"	48"/ 48"	1"	30	1	\$601	\$535
__TRCWS484830	30"	48"/ 48"	1"	30	1	\$601	\$601
__TRCWS606024	24"	60"/ 60"	1"	47	1	\$752	\$675
__TRCWS606030	30"	60"/ 60"	1"	47	1	\$752	\$675

Note: When ordering, insert MM for Maverick Series or AR for Arroyo before model number.

Pre Drill Holes: Tops are pre-drill for Post Legs MMLEGTRB – MMLEGTRSC.

Ganging Hardware: Is recommended when placing tops side by side.  Lead Time.

training tables

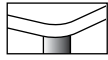

Maverick (MM)
Radius Edges

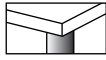

Arroyo (AR)
Square Edges

Training Worksurfaces 15 DAYS

Curved Computer Training Table Top 24"D Right Connection (MM-Radius Edges, AR-Square Edges)

Model#	Depth	Width	Corner	Height	Weight	Cube	MM Price	AR Price
__CDQ60TOP 4R	24" / 24"	60"	36"	1"	68	2	\$609	\$543
__CDQ66TOP 4R	24" / 24"	66"	36"	1"	68	2	\$642	\$575
__CDQ72TOP 4R	24" / 24"	72"	36"	1"	79	2	\$660	\$595
__CDQ72TOP 9R	30" / 24"	72"	42"	1"	79	2	\$699	\$633

Note: When ordering, Insert MM for Maverick Series or AR for Arroyo Series. Wood grain runs the width direction. Maverick series tops have three radius corners.
Predrill Holes: Tops are not predrilled. Must order with return top. Designed for Adjustable Height L-UNIT Base only.
Grommet: Standard black grommet, location 7"x7" upgrade grommet to color silver n/c.

15 LEAD TIME

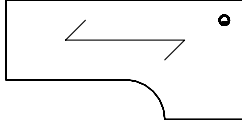

Curved Computer Training Table Top 24"D Left Connection (MM-Radius Edges, AR-Square Edges)

Model#	Depth	Width	Corner	Height	Weight	Cube	MM Price	AR Price
__CDQ60TOP 4L	24" / 24"	60"	36"	1"	68	2	\$609	\$543
__CDQ66TOP 4L	24" / 24"	66"	36"	1"	68	2	\$642	\$575
__CDQ72TOP 4L	24" / 24"	72"	36"	1"	79	2	\$660	\$595
__CDQ72TOP 9L	24" / 30"	72"	42"	1"	79	2	\$699	\$633

Note: When ordering, Insert MM for Maverick Series or AR for Arroyo Series. Wood grain runs the width direction. Maverick series tops have three radius corners.
Predrill Holes: Tops are not predrilled. Must order with return top. Designed for Adjustable Height L-UNIT Base only.
Grommet: Standard black grommet, location 7"x7" upgrade grommet to color silver n/c.

15 LEAD TIME

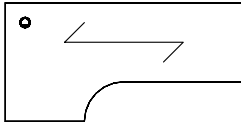

Rectangular Training Return Top, 24"D Tops (MM-Radius Edges, AR-Square Edges)

Model#	Depth	Width	Height	Weight	Cube	MM Price	AR Price
__TRT2436	24"	36"	1"	30	1	\$385	\$350
__TRT2442	24"	42"	1"	32	1	\$397	\$364
__TRT2448	24"	48"	1"	36	1	\$411	\$379

Note: When ordering, Insert MM for Maverick Series or AR for Arroyo Series. Return top wood grain runs vertical direction. Maverick series tops have two radius edges.
Predrill Holes: Tops are not predrilled. Must order with computer table top. Designed for Adjustable Height L-UNIT Base only.
Connecting Hardware: 2 connecting brackets with wood screws are included.

15 LEAD TIME

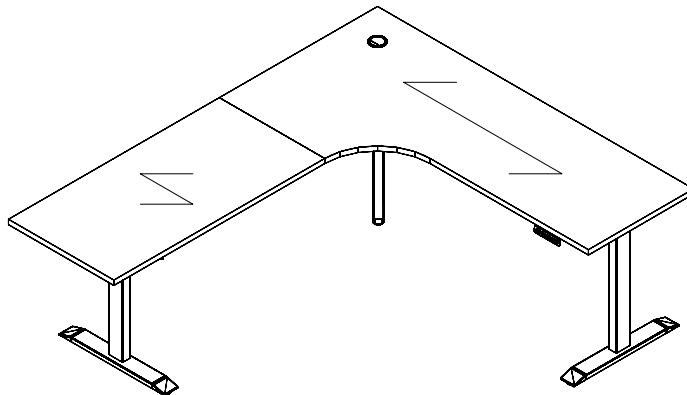
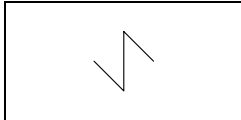

Note: Line drawings shown in square corners (AR series)

training tables

Bases, for Training Table Tops

(Leg heights vary and cannot be combined)



Post Leg 2 3/8" diameter (Set of 4 legs) for Training Table Tops

Model#	Description	Color	Height	Price
☞ MMLEGTB	4 Posts with Leveler	Black	27 13/16"	\$514
☞ MMLEGTB	4 Posts with Leveler	Brushed Steel	27 13/16"	\$514
☞ MMLEGTB	4 Posts with Locking Casters	Black	27 15/16"	\$514
☞ MMLEGTB	4 Posts with Locking Casters	Brushed Steel	27 15/16"	\$514
☞ MMCULEG_	1 Individual Post Leg		27 15/16"	\$130

For individual post legs...\$130 each. Specify complete model #MMCULEG_ (e.g. MMCULEGTB)
 Individual post leg includes mounting screws.
 Legs are shipped un-installed and require minor assembly with woodscrews for each leg.
 Tops 72"W, 78"W & 84"W requires 5-post legs. Tops are pre-drilled for 4-post legs only.

☞ LEAD TIME



Flip Top Base with Modesty, Locking Casters (Complete leg, black color only)

Model#	Depth	Width	Height	Fits Top Size	Color	Weight	Cube	Price
☞ MMLEGF4836	20"	24"	28 1/2"	36" & 48"W	Black	42	1	\$581
☞ MMLEGF7260	20"	58"	28 1/2"	60" & 72"W	Black	42	1	\$788

For rectangular tops 20"D & 24"D only. See p. 158.
 Bases ship unassembled unless otherwise specified. Tops are pre-drilled for flip top bases.
 Ganging hardware is recommended when placing tops side by side, see p. 164.

☞ LEAD TIME

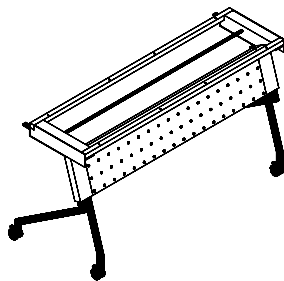

Flip Top Base with Frame Modesty, Locking Casters (1 complete leg)

Model#	Depth	Width	Height	Fits Top Size	Color	Weight	Cube	Price
* MMLEGF48S	14/20"	40 1/4"	28 1/2"	48" & 54"W	Silver	36	1	\$626
MMLEGF48B	14/20"	40 1/4"	28 1/2"	48" & 54"W	Black	36	1	\$626
MMLEGF48W	14/20"	40 1/4"	28 1/2"	48" & 54"W	White	36	1	\$626
* MMLEGF60S	14/20"	52"	28 1/2"	60" & 66"W	Silver	40	1	\$696
MMLEGF60B	14/20"	52"	28 1/2"	60" & 66"W	Black	40	1	\$696
MMLEGF60W	14/20"	52"	28 1/2"	60" & 66"W	White	40	1	\$696
* MMLEGF72S	14/20"	63 1/4"	28 1/2"	72" & 78"W	Silver	43	1	\$813
MMLEGF72B	14/20"	63 1/4"	28 1/2"	72" & 78"W	Black	43	1	\$813
MMLEGF72W	14/20"	63 1/4"	28 1/2"	72" & 78"W	White	43	1	\$813

For rectangular tops 20"D & 24"D only, see p. 158.
 *Note: color silver (Titanium/Metal) does not match other silver legs.
 Bases ship unassembled unless otherwise specified. Tops are not pre-drill.

15 LEAD TIME

training tables

Bases, for Training Table Tops

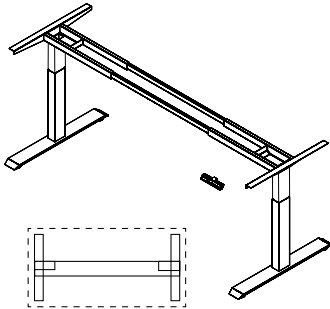

Adjustable Height Electrical Base (Sit to stand, fits top sizes below)

Model#	Base (D)	Base (W)	Height	Fits Top Size	Color	Weight	Cube	Price
MMLEGAHE24S3	22"	47"-72"	23 1/2"-49"	24"D-72"W	Silver	64	1	\$1,736
MMLEGAHE24B3	22"	47"-72"	23 1/2"-49"	24"D-72"W	Black	64	1	\$1,736
MMLEGAHE24W3	22"	47"-72"	23 1/2"-49"	24"D-72"W	White	64	1	\$1,736
MMLEGAHE30S3	28"	47"-72"	23 1/2"-49"	30"D-72"W	Silver	64	1	\$1,736
MMLEGAHE30B3	28"	47"-72"	23 1/2"-49"	30"D-72"W	Black	64	1	\$1,736
MMLEGAHE30W3	28"	47"-72"	23 1/2"-49"	30"D-72"W	White	64	1	\$1,736

Does not include top. **3 stage base.** Bases ship unassembled unless otherwise specified.

15 LEAD TIME

Handset	Push Button/4 memory presets
Motor	Dual motor
Foot Length	28"
Height range (excluding top)	23.5" - 49"
Frame width	Width adjustable 48" - 72"
Worksurface widths	48" - 72"
Worksurface depths	24" & 30"
Max lifting capacity	250lbs.
Base Weight	66lbs.
Speed	30mm/s
Warranty	5 years

Adjustable Height Electrical L-Unit Base (Sit to stand, fits top sizes below)

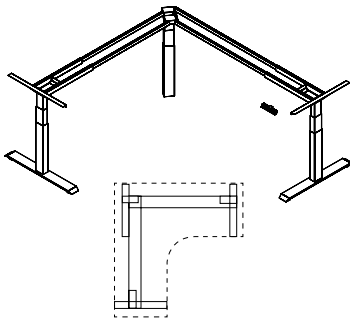

Model#	Base (D)	Base (W)	Height	Fits Top Size	Color	Weight	Cube	Price
MMLEGAHEL24B3	22"	48"-72"	23 1/2"-49"	24"D-72"W	Black	112	1	\$2,600
MMLEGAHEL24S3	22"	48"-72"	23 1/2"-49"	24"D-72"W	Silver	112	1	\$2,600
MMLEGAHEL24W3	22"	48"-72"	23 1/2"-49"	24"D-72"W	White	112	1	\$2,600
MMLEGAHEL30S3	28"	48"-72"	23 1/2"-49"	30"D-72"W	Silver	112	1	\$2,600
MMLEGAHEL30W3	28"	48"-72"	23 1/2"-49"	30"D-72"W	White	112	1	\$2,600
MMLEGAHEL30B3	28"	48"-72"	23 1/2"-49"	30"D-72"W	Black	112	1	\$2,600

Does not include top. **3 stage base.** Bases ship unassembled unless otherwise specified.

15 LEAD TIME

Handset	Push Button/4 memory presets
Motor	Triple motor
Foot Length	28"
Height range (excluding top)	23.5" - 49"
Frame width	Width adjustable 48" - 72"
Worksurface widths	48" - 72"
Worksurface depths	24" & 30"
Max lifting capacity	300lbs.
Base Weight	112lbs.
Speed	33mm/s
Warranty	5 years

training tables

Bases, for Training Table Tops

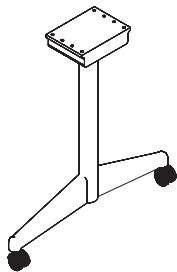
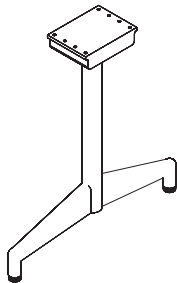
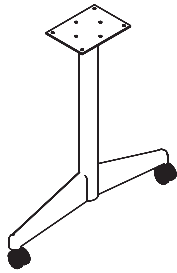
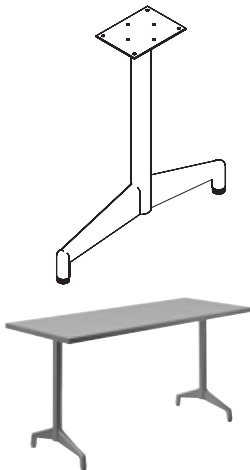

T-Leg with Leveler (Set of 2 legs)								
Model#	Depth	Width	Height	Fits Top Size	Color	Weight	Cube	Price
MMLEGTL20S	20"	2 1/4"	28"	20/24"D-72"W	Silver	23	4	\$932
MMLEGTL20B	20"	2 1/4"	28"	20/24"D-72"W	Black	23	4	\$932
MMLEGTL20W	20"	2 1/4"	28"	20/24"D-72"W	White	23	4	\$932
MMLEGTL30S	30"	2 1/4"	28"	30/36"D-72"W	Silver	23	4	\$1,001
MMLEGTL30B	30"	2 1/4"	28"	30/36"D-72"W	Black	23	4	\$1,001
MMLEGTL30W	30"	2 1/4"	28"	30/36"D-72"W	White	23	4	\$1,001

Column diameter 2 1/4", mounting plate 6"D x 8"W. Base Spread: 20"D is 20"W. 30"D is 26"W.
 Stabilizer Bar: 1 is included with 60"W, 66"W & 72"W tops, when ordered with T-Legs.
 Legs ship unassembled unless otherwise specified. **15** LEAD TIME

T-Leg with Casters (Set of 2 legs, locking casters)								
Model#	Depth	Width	Height	Fits Top Size	Color	Weight	Cube	Price
MMLEGTc20S	20"	2 1/4"	28"	20/24"D-72"W	Silver	23	4	\$950
MMLEGTc20B	20"	2 1/4"	28"	20/24"D-72"W	Black	23	4	\$950
MMLEGTc20W	20"	2 1/4"	28"	20/24"D-72"W	White	23	4	\$950
MMLEGTc30S	30"	2 1/4"	28"	30/36"D-72"W	Silver	23	4	\$1,020
MMLEGTc30B	30"	2 1/4"	28"	30/36"D-72"W	Black	23	4	\$1,020
MMLEGTc30W	30"	2 1/4"	28"	30/36"D-72"W	White	23	4	\$1,020

Column diameter 2 1/4", mounting plate 6"D x 8"W. Base Spread: 20"D is 20"W. 30"D is 26"W.
 Stabilizer Bar: 1 is included with 60"W, 66"W & 72"W tops, when ordered with T-Legs.
 Legs ship unassembled unless otherwise specified. **15** LEAD TIME

Flip Top Base with Leveler (Set of 2 legs)								
Model#	Depth	Width	Height	Fits Top Size	Color	Weight	Cube	Price
MMLEGTfL20S	20"	2 1/4"	28"	20/24"D-72"W	Silver	23	4	\$1,230
MMLEGTfL20B	20"	2 1/4"	28"	20/24"D-72"W	Black	23	4	\$1,230
MMLEGTfL20W	20"	2 1/4"	28"	20/24"D-72"W	White	23	4	\$1,230
MMLEGTfL30S	30"	2 1/4"	28"	30/36"D-72"W	Silver	23	4	\$1,275
MMLEGTfL30B	30"	2 1/4"	28"	30/36"D-72"W	Black	23	4	\$1,275
MMLEGTfL30W	30"	2 1/4"	28"	30/36"D-72"W	White	23	4	\$1,275

Column diameter 2 1/4", Flip Top Mechanism is mechanically attached to the base.
 Base Spread: 20"D is 20"W. 30"D is 26"W. Use with rectangular tops, see pp. 158-159.
 Stabilizer Bar: 1 is included with 60"W, 66"W & 72"W tops, when ordered with Flip Top Base.
 Base ship unassembled unless otherwise specified. **15** LEAD TIME

Flip Top Base with Casters (Set of 2 legs, locking casters)								
Model#	Depth	Width	Height	Fits Top Size	Color	Weight	Cube	Price
MMLEGTfC20S	20"	2 1/4"	28"	20/24"D-72"W	Silver	23	4	\$1,294
MMLEGTfC20B	20"	2 1/4"	28"	20/24"D-72"W	Black	23	4	\$1,294
MMLEGTfC20W	20"	2 1/4"	28"	20/24"D-72"W	White	23	4	\$1,294
MMLEGTfC30S	30"	2 1/4"	28"	30/36"D-72"W	Silver	23	4	\$1,340
MMLEGTfC30B	30"	2 1/4"	28"	30/36"D-72"W	Black	23	4	\$1,340
MMLEGTfC30W	30"	2 1/4"	28"	30/36"D-72"W	White	23	4	\$1,340

Column diameter 2 1/4", Flip Top Mechanism is mechanically attached to the base.
 Base Spread: 20"D is 20"W. 30"D is 26"W. Use with rectangular tops, see pp. 158-159.
 Stabilizer Bar: 1 is included with 60"W, 66"W & 72"W tops, when ordered with Flip Top Base.
 Base ship unassembled unless otherwise specified. **15** LEAD TIME



NOTE: All bases on this page, for heavy use on 60"W or wider tops, a second stabilizer bar is recommended, see p. 164 for sizes and pricing.

Hinged Modesty Panels Available for Bases Above, See p. 164.

training tables

Modesty Panels

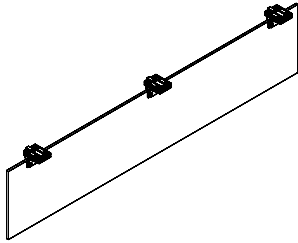

Frosted Acrylic Hinged Modesty (3/8" thick. Black Clips)

Model#	Depth	Width	Height	Clips	Top Width	Weight	Cube	Price
MMTRAM54	3"	41"	13 1/2"	2	54"	10	2	\$911
MMTRAM60	3"	47"	13 1/2"	2	60"	11	2	\$916
MMTRAM66	3"	53"	13 1/2"	3	66"	12	2	\$986
MMTRAM72	3"	59"	13 1/2"	3	72"	13	2	\$994

Designed to fit T-Legs and Flip Top Bases, see p. 163. Modesty Panel: 20"D & 24"D is flush, 30"D is inset 6". Depth and Height includes clips. Tops are predrilled to accept modesty.

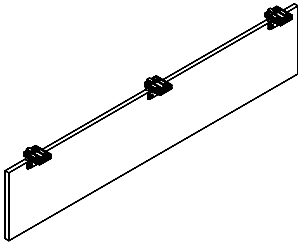

TFM Hinged Modesty (3/4" thick. Black Clips)

Model#	Depth	Width	Height	Clips	Top Width	Weight	Cube	Price
MMTRWM54	3"	41"	13 1/2"	2	54"	10	2	\$297
MMTRWM60	3"	47"	13 1/2"	2	60"	11	2	\$319
MMTRWM66	3"	53"	13 1/2"	3	66"	12	2	\$392
MMTRWM72	3"	59"	13 1/2"	3	72"	13	2	\$392

Designed to fit T-Legs and Flip Top Bases, see p. 163. Modesty Panel: 20"D & 24"D is flush, 30"D is inset 6". Depth and Height includes clips. Tops are predrilled to accept modesty.

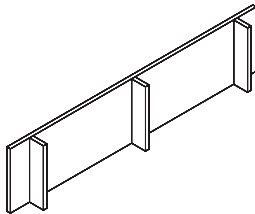

TFM Modesty (3/4" thick. Three vertical supports)

Model#	Depth	Width	Height	Top Width	Weight	Cube	Price
APPSLW54	4"	47"	12"	54"	15	2	\$147
APPSLW60	4"	53"	12"	60"	16	2	\$168
APPSLW66	4"	59"	12"	66"	18	2	\$179
APPSLW72	4"	65"	12"	72"	19	2	\$179

Ships with brackets for field installed. Tops are not predrilled.

NOTE: Modesty panel standard location is center left to right to approach side under tops. For custom location must specify, add MMCUT3 \$208.

Accessories and Upgrades

MMGANG3

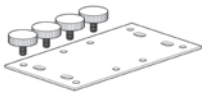

MMGANG4

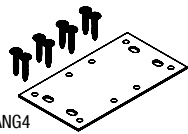

Ganging and Connecting Hardware (For use with factory-installed metal inserts)

Model#	Depth	Width	Height	Hardware	Weight	Cube	Price
MMGANG3	4"	6"	.25"	Ganging	1	1	\$48
MMGANG4	4"	6"	.25"	Connecting	1	1	\$48

MMGANG3: (1) Bracket & (4) Knobs. Recommended when placing tops side by side.
MMGANG4: (1) Bracket & (4) Screws. Can be used for "L" shape & "U" shape connections.



Grommet

Model#	Depth	Width	Color	Surface Hole Diameter	Price
MMGR234B	3"	3"	Black Plastic	2 3/4"	\$65
MMGR234S	3"	3"	Silver Plastic	2 3/4"	\$65

Specify grommet locations. Standard left, right or center, see p. 157 for standard location.

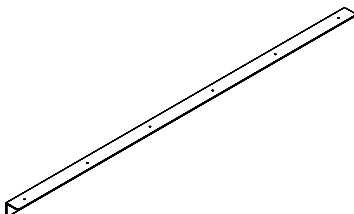

Stabilizer Bar, Black

Model#	Depth	Width	Height	Fits Top	Weight	Cube	Price
MMSB60	2"	44"	2"	60"W	6	1	\$138
MMSB66	2"	50"	2"	66"W	7	1	\$149
MMSB72	2"	56"	2"	72"W	8	1	\$161

May be purchased separately.
2 Stabilizer bars are included with 60"W, 66"W & 72"W tops, when purchased with top and post legs.