

summit series



Summit for the common workspace, private or home office.

summit series

Configurations

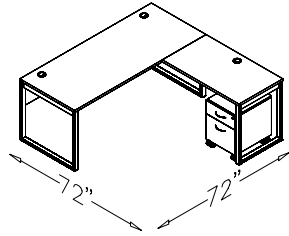

SM1R				
Qty	Part #	Unit Price	Extended Price	
1	SMTR3072	\$456	\$456	
1	SMTR2442	\$343	\$343	
2	SMDSL30	\$300	\$600	
1	SMDSL24	\$259	\$259	
1	SMTRM72	\$154	\$154	
1	SMGANG1	\$54	\$54	
1	SMPEDAX20	\$957	\$957	
Total			\$2,823	

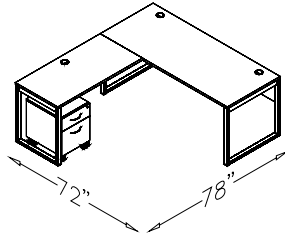

SM2L				
Qty	Part #	Unit Price	Extended Price	
1	SMTR3072	\$456	\$456	
1	SMTR2448	\$359	\$359	
2	SMDSL30	\$300	\$600	
1	SMDSL24	\$259	\$259	
1	SMTRM72	\$154	\$154	
1	SMGANG1	\$54	\$54	
1	SMPEDAX20	\$957	\$957	
Total			\$2,839	

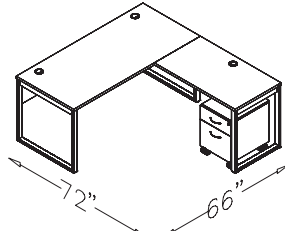

SM3R				
Qty	Part #	Unit Price	Extended Price	
1	SMTR3066	\$434	\$434	
1	SMTR2442	\$343	\$343	
2	SMDSL30	\$300	\$600	
1	SMDSL24	\$259	\$259	
1	SMTRM66	\$142	\$142	
1	SMGANG1	\$54	\$54	
1	SMPEDAX20	\$957	\$957	
Total			\$2,789	

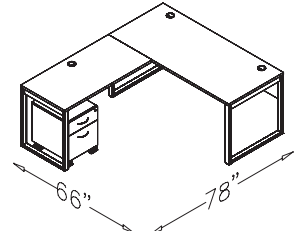

SM4L				
Qty	Part #	Unit Price	Extended Price	
1	SMTR3066	\$434	\$434	
1	SMTR2448	\$359	\$359	
2	SMDSL30	\$300	\$600	
1	SMDSL24	\$259	\$259	
1	SMTRM66	\$142	\$142	
1	SMGANG1	\$54	\$54	
1	SMPEDAX20	\$957	\$957	
Total			\$2,805	

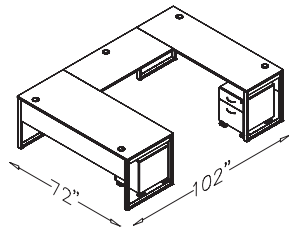

SM5				
Qty	Part #	Unit Price	Extended Price	
1	SMTR3072	\$456	\$456	
1	SMTR2448	\$359	\$359	
1	SMTR2472	\$450	\$450	
2	SMDSL30	\$300	\$600	
2	SMDSL24	\$259	\$518	
2	SMTRM72	\$154	\$308	
1	SMGANG2	\$108	\$108	
2	SMPEDAX20	\$957	\$1,914	
Total			\$4,713	

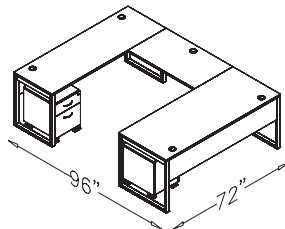

SM6				
Qty	Part #	Unit Price	Extended Price	
1	SMTR3072	\$456	\$456	
1	SMTR2442	\$343	\$343	
1	SMTR2472	\$450	\$450	
2	SMDSL30	\$300	\$600	
2	SMDSL24	\$259	\$518	
2	SMTRM72	\$154	\$308	
1	SMGANG2	\$108	\$108	
2	SMPEDAX20	\$957	\$1,914	
Total			\$4,697	

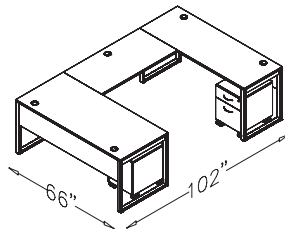

SM7				
Qty	Part #	Unit Price	Extended Price	
1	SMTR3066	\$434	\$434	
1	SMTR2448	\$359	\$359	
1	SMTR2466	\$407	\$407	
2	SMDSL30	\$300	\$600	
2	SMDSL24	\$259	\$518	
2	SMTRM66	\$142	\$284	
1	SMGANG2	\$108	\$108	
2	SMPEDAX20	\$957	\$1,914	
Total			\$4,624	

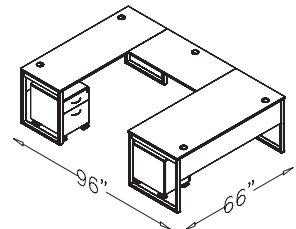

SM8				
Qty	Part #	Unit Price	Extended Price	
1	SMTR3066	\$434	\$434	
1	SMTR2442	\$343	\$343	
1	SMTR2466	\$407	\$407	
2	SMDSL30	\$300	\$600	
2	SMDSL24	\$259	\$518	
2	SMTRM66	\$142	\$284	
1	SMGANG2	\$108	\$108	
2	SMPEDAX20	\$957	\$1,914	
Total			\$4,608	

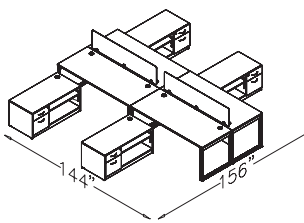

SM9				
Qty	Part #	Unit Price	Extended Price	
4	SMTR3072	\$456	\$1,824	
8	SMDSL30	\$300	\$2,400	
4	SMTRM72	\$154	\$616	
2	SMPSU72	\$467	\$934	
2	SMSBF2448L	\$1,842	\$3,684	
2	SMSBF2448R	\$1,842	\$3,684	
Total			\$13,142	

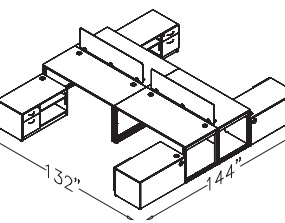

SM10				
Qty	Part #	Unit Price	Extended Price	
4	SMTR3066	\$434	\$1,736	
8	SMDSL30	\$300	\$2,400	
4	SMTRM66	\$142	\$568	
2	SMPSU66	\$421	\$842	
2	SMSBF2442L	\$1,802	\$3,604	
2	SMSBF2442R	\$1,802	\$3,604	
Total			\$12,754	

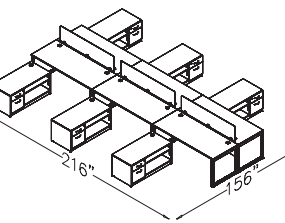

SM11				
Qty	Part #	Unit Price	Extended Price	
6	SMTR3072	\$456	\$2,736	
12	SMDSL30	\$300	\$3,600	
6	SMTRM72	\$154	\$924	
3	SMPSU72	\$467	\$1,401	
3	SMSBF2448L	\$1,842	\$5,526	
3	SMSBF2448R	\$1,842	\$5,526	
Total			\$19,713	

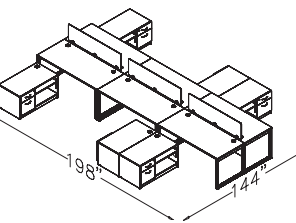

SM12				
Qty	Part #	Unit Price	Extended Price	
6	SMTR3066	\$434	\$2,604	
12	SMDSL30	\$300	\$3,600	
6	SMTRM66	\$142	\$852	
3	SMPSU66	\$421	\$1,263	
3	SMSBF2442L	\$1,802	\$5,406	
3	SMSBF2442R	\$1,802	\$5,406	
Total			\$19,131	

summit series

Configurations

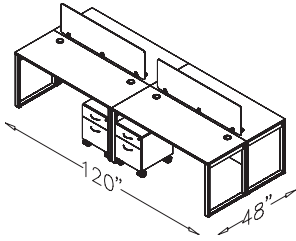

SM13			
Qty	Part #	Unit Price	Extended Price
4	SMTR2460	\$392	\$1,568
8	SMDSL24	\$259	\$2,072
4	SMTRM60	\$135	\$540
2	SMPSU60	\$421	\$842
4	SMPEDAX20	\$957	\$3,828
Total			\$8,850

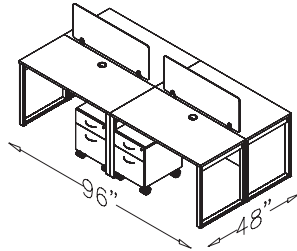

SM14			
Qty	Part #	Unit Price	Extended Price
4	SMTR2448	\$359	\$1,436
8	SMDSL24	\$259	\$2,072
4	SMTRM48	\$110	\$440
2	SMPSU48	\$375	\$750
4	SMPEDAX20	\$957	\$3,828
Total			\$8,526

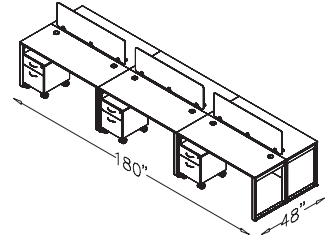

SM15			
Qty	Part #	Unit Price	Extended Price
6	SMTR2460	\$392	\$2,352
12	SMDSL24	\$259	\$3,108
6	SMTRM60	\$135	\$810
3	SMPSU60	\$421	\$1,263
6	SMPEDAX20	\$957	\$5,742
Total			\$13,275

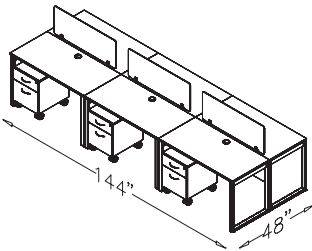

SM16			
Qty	Part #	Unit Price	Extended Price
6	SMTR2448	\$359	\$2,154
12	SMDSL24	\$259	\$3,108
6	SMTRM48	\$110	\$660
3	SMPSU48	\$375	\$1,125
6	SMPEDAX20	\$957	\$5,742
Total			\$12,789

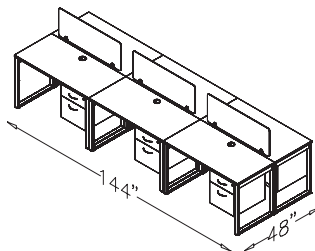

SM17			
Qty	Part #	Unit Price	Extended Price
6	SMTR2448	\$359	\$2,154
12	SMDSL24	\$259	\$3,108
6	SMTRM48	\$110	\$660
3	SMPSU48	\$375	\$1,125
3	SMPEDBF20L	\$736	\$2,208
3	SMPEDBF20R	\$736	\$2,208
Total			\$11,463

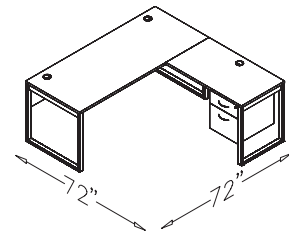

SM18R			
Qty	Part #	Unit Price	Extended Price
1	SMTR3072	\$456	\$456
1	SMTR2442	\$343	\$343
2	SMDSL30	\$300	\$600
1	SMDSL24	\$259	\$259
1	SMTRM72	\$154	\$154
1	SMGANG1	\$54	\$54
1	SMPEDBF20R	\$736	\$736
Total			\$2,602

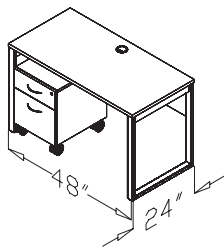

SM19			
Qty	Part #	Unit Price	Extended Price
1	SMTR2448	\$359	\$359
2	SMDSL24	\$259	\$518
1	SMTRM48	\$110	\$110
1	SMPEDAX20	\$957	\$957
Total			\$1,944

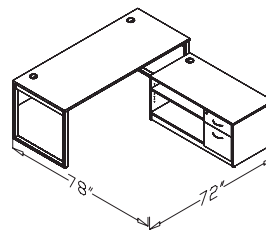

SM20R			
Qty	Part #	Unit Price	Extended Price
1	SMTR3072	\$456	\$456
2	SMDSL30	\$300	\$600
1	SMTRM72	\$154	\$154
1	SMSBF2448R	\$1,842	\$1,842
Total			\$3,052

summit series

Summit Series (SM) | 5 Day Lead Time | No customs, changes or design work

Standard Features

Items ship separately for field installation. Tops & Credenzas have silver grommets. Tops have no pre-drilled holes. Pedestals & Credenzas with Box/File have a face lock & H3S silver handles. One stabilizer bar is standard with tops 60"W, 66"W & 72"W (must order with modesty). Modesty panel must be ordered for tops, unless tops are being used as a bridge or return top. If unit is freestanding, modesty panel is required.

Color Options

20 Standard TFM colors, two colors may be specified. See Summit color options, page 172. For inlayed tops, specify top color & top edge color. Specify base color and drawer front color. Woodgrain colors, grain runs horizontal on all tops.

Worksurfaces

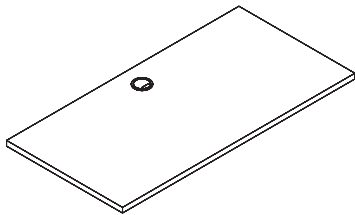

Rectangular Top Square Corners, Center Grommet

Model#	Depth	Width	Height	Weight	Cube	Price
SMTR2436	24"	36"	1"	23	1	\$330
SMTR2442	24"	42"	1"	27	1	\$343
SMTR2448	24"	48"	1"	30	1	\$359

One silver grommet center of top, 4" from approach. No pre-drilled holes. Change Grommet color to Black, add SMUGR234B at no charge. Freestanding units require modesty, see page 168. No modesty is required for bridge or return top.

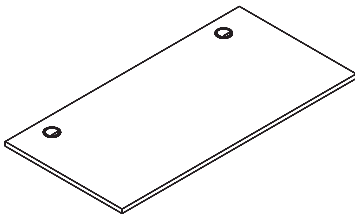

Rectangular Top Square Corners, Left & Right Grommet (1 Stabilizer bar SMSB35)

Model#	Depth	Width	Height	Weight	Cube	Price
SMTR2460	24"	60"	1"	38	1	\$392
SMTR2466	24"	66"	1"	42	1	\$407
SMTR2472	24"	72"	1"	45	1	\$450
SMTR3060	30"	60"	1"	47	1	\$392
SMTR3066	30"	66"	1"	52	2	\$434
SMTR3072	30"	72"	1"	57	2	\$456

Two silver grommets. Left & Right side of top. All tops require modesty, see page 168. 24"D tops, grommets are 4" from approach. 30"D tops, grommets are 8 1/2" from approach. SMSB35: One Stabilizer Bar is standard with 60"W, 66"W & 72"W tops. Must order with modesty. No pre-drilled holes. Change grommet color to black, add SMUGR234B at no charge.

Privacy Screens

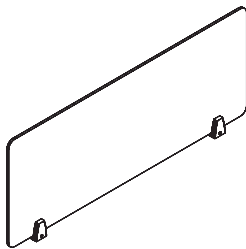

Frosted Acrylic Privacy Screen, Two Mounting Clips

Model#	Depth	Width	Height	Fits Top	Weight	Cube	Price
SMPSU24	1/4"	22"	15"	24"D	4	1	\$243
SMPSU30	1/4"	28"	15"	30"D	6	1	\$314
SMPSU36	1/4"	34"	15"	36"W	7	1	\$336
SMPSU48	1/4"	45"	15"	48"W	9	1	\$375
SMPSU60	1/4"	58"	15"	60"W	11	1	\$421
SMPSU66	1/4"	64"	15"	66"W	12	1	\$421
SMPSU72	1/4"	69"	15"	72"W	13	1	\$467

Includes mounting hardware for field installation. Width is approximate.

summit series

Modesty Panels

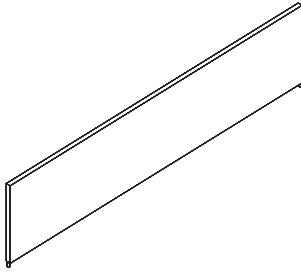

Modesty Panel TFM, Edgedbanded 3 Sides

Model#	Depth	Width	Height	Fits Top	Weight	Cube	Price
SMTRM36	3/4"	31 3/4"	12"	36"W	12	1	\$100
SMTRM42	3/4"	37 3/4"	12"	42"W	14	1	\$106
SMTRM48	3/4"	43 3/4"	12"	48"W	15	1	\$110
SMTRM60	3/4"	55 3/4"	12"	60"W	19	1	\$135
SMTRM66	3/4"	61 3/4"	12"	66"W	21	1	\$142
SMTRM72	3/4"	67 3/4"	12"	72"W	23	1	\$154

Grain runs horizontal. Includes mounting hardware to field install underside top & legs with L-brackets.

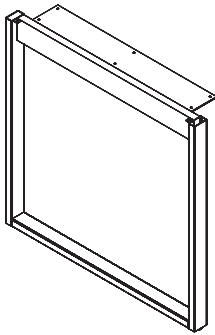

Metal Legs

D-Shape Metal Leg 2", Silver

Model#	Depth	Width	Height	Fits Top	Weight	Cube	Price
SMDSL24	24"	2"	28"	24"D	26	3	\$259
SMDSL30	30"	2"	28"	30"D	29	4	\$300

Includes hardware for field installation. Legs are designed to accept modesty (must order with modesty). One Stabilizer Bar is standard with 60"W, 66"W & 72"W tops (must order with modesty).

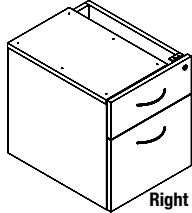

Right mount
(SMPEDBF20R)

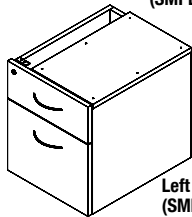

Left mount
(SMPEDBF20L)

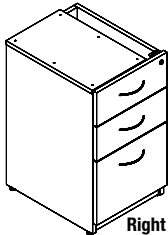

Right mount
(SMPEDBBF20R)

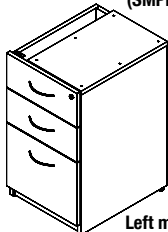

Left mount
(SMPEDBBF20L)

Pedestals

Mounting Box/File Pedestal, Finished All Sides (Right face lock, H3S handles)

Model#	Depth	Width	Height	Fits Top	Weight	Cube	Price
SMPEDBF20R	20"	16"	18 3/4"	24 - 30"D	65	5	\$736
SMPEDBF20L	20"	16"	18 3/4"	24 - 30"D	65	5	\$736

Handle Option: Specify H3B-H10B, H13 & H14 at no charge. For H11 handles, add \$94 list each. Pedestal mounting hardware ships separately for field install.

Mounting Box/Box/File Pedestal, Finished All Sides (Right face lock, H3S handles)

Model#	Depth	Width	Height	Weight	Cube	Price
SMPEDBBF20R	20"	16"	28"	77	6	\$1,307
SMPEDBBF20L	20"	16"	28"	77	6	\$1,307

Handle Option: Specify H3B-H10B, H13 & H14 at no charge. For H11 handles, add \$94 list each. Pedestal mounting hardware ships separately for field install.

summit series

Pedestals

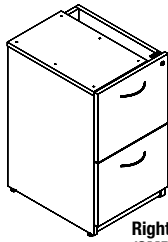

Right mount
(SMPEDFF20R)

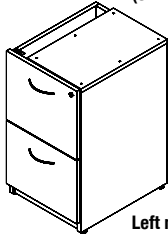

Left mount
(SMPEDFF20L)

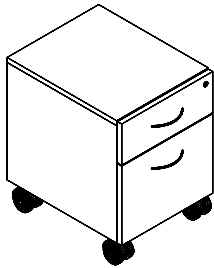

Mounting File/File Pedestal, Finished All Sides (Right face lock, H3S handles)

Model#	Depth	Width	Height	Weight	Cube	Price
SMPEDFF20R	20"	16"	28"	73	6	\$1,255
SMPEDFF20L	20"	16"	28"	73	6	\$1,255

Handle Option: Specify H3B-H10B, H13 & H14 at no charge.
For H11 handles, add \$94 list each. Pedestal mounting hardware ships separately for field install.

Mobile Pedestal Box/File, with Casters (Right face lock, H3S handles)

Model#	Depth	Width	Height	Fits Top	Weight	Cube	Price
SMPEDAX20	20"	16"	21"	24 - 30"D	73	5	\$957

Handle Option: Specify H3B-H10B, H13 & H14 at no charge. For H11 handles, add \$94 list each.

Low Credenzas

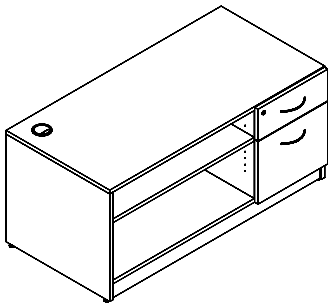

Credenza Right Box/File Pedestal, Left Opening 1 Adjustable Shelf (Face lock, H3S handles & 2 grommets)

Model#	Depth	Width	Height	Weight	Cube	Price
SMSBF2442R	24"	42"	21"	150	13	\$1,802
SMSBF2448R	24"	48"	21"	167	16	\$1,842

Handle Option: Specify H3B-H10B, H13 & H14 at no charge. Silver grommets located on the left side of the top & back panel. Change grommet color to black, add SMUGR234B at no charge.

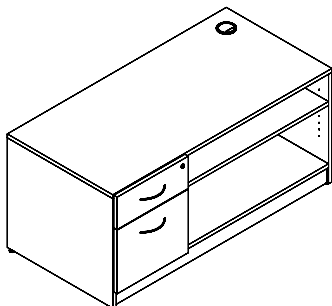

Credenza Left Box/File Pedestal, Right Opening 1 Adjustable Shelf (Face lock, H3S handles & 2 grommets)

Model#	Depth	Width	Height	Weight	Cube	Price
SMSBF2442L	24"	42"	21"	150	13	\$1,802
SMSBF2448L	24"	48"	21"	167	16	\$1,842

Handle Option: Specify H3B-H10B, H13 & H14 at no charge. Silver grommets located on the right side of the top & back panel. Change grommet color to black, add SMUGR234B at no charge.

summit series

Conference

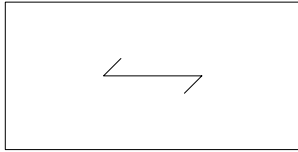

Rectangular Conference Top, Square Corners (1" Thick, no pre-drilled holes)

Model#	Depth	Width	Height	Top	Legs & Modesty (req.)	Weight	Cube	Price
SMRE4296	42"	96"	1"	1pc	SMDSL24 SMTRM60	111	3	\$816
SMRE4896	48"	96"	1"	1pc	SMDSL24 SMTRM60	127	3	\$1,114

Tops require (2) D-Shape Legs 2" and (2) Modesties (not included). For pricing, see page 168.

Data/Power Management

(Option to add on conference tables top only)



Round Power Grommet (1 Power, 2 power USB, 1 switching adapter, 60" cord)

Model#	Depth	Width	Surface Hole Diameter	Color	Weight	Cube	Price
GRPRGR3B	3 1/2"	3 1/2"	3 3/16"	Black	2	1	\$268
GRPRGR3S	3 1/2"	3 1/2"	3 3/16"	Silver	2	1	\$268

For conference table tops only. Specify cut-out left, center or right side. See page 171.



Metal Power Management Unit

(2 Power, 1 data, 2 power USB with adapter, 1 HDMI, 1 RJ45, 1 RJ11)

Model#	Dimensions	Color	Weight	Cube	Price
MMPWRDLX2S	5 3/8"D x 9"W	Brushed Silver	2	1	\$1,644
MMPWRDLX2B	5 3/8"D x 9"W	Black	2	1	\$1,644

Metal Silver finish. Includes top cutout (Horizontal).

For conference table tops only. Specify cut-out location left, center or right side. See page 171.

Note: Includes 8 wire-management clips. Data capability CAT6. Surge protected - 6' cord.

Requires 20 lead time.

Accessories

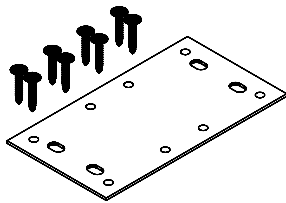

Connecting Hardware (Brackets & screws)

Model#	Depth	Width	Height	Brackets & Wood Screws	Weight	Cube	Price
SMGANG1	4"	6"	1/4"	2 16	2	1	\$54
SMGANG2	4"	6"	1/4"	4 32	3	1	\$108

Required if connecting tops. Tops are not pre-drilled, field drilling and installation is required.

Specify SMGANG1 if connecting return tops, SMGANG2 if connecting bridge tops.

Note: Can be purchased separately for customer's own use.

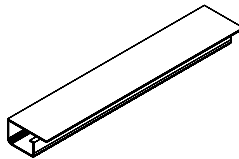

Plastic Wire Management Trough, Black

Model#	Depth	Width	Height	Weight	Cube	Price
SMPWM12	2"	12"	2"	1	1	\$29
SMPWM18	2"	18"	2"	1	1	\$29

Field installed under tops with #8x1" wood screw (supplied) Available in black only.

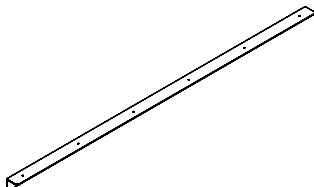

Stabilizer Bar

Model#	Depth	Width	Height	Weight	Cube	Price
SMSB35	2"	35"	2"	5	1	\$141

Required if not standard. May be purchased separately.

One is included with 60"W, 66"W & 72"W summit tops, when purchased with legs & modesty.

summit series

Conference Data/Power Cut-out Reference Guide

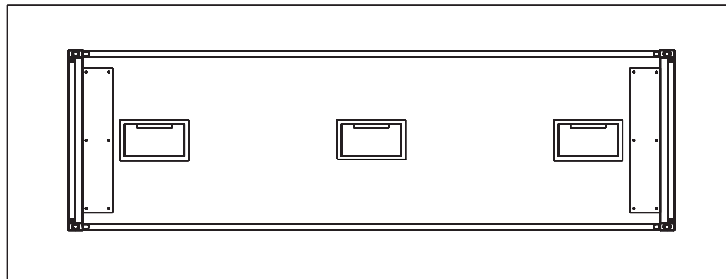

Specify cut-out location: Left, center or right side

Options



Bar Square Handle, Silver Finish

Model#	Hole Center	Width	Weight	Cube	Price
MMH11	11"	11 3/8"	1	1	\$94/ea.

Handle upgrade.

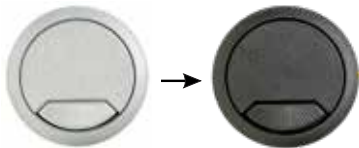

Upgrade Grommet Color from Standard Silver to Black

Model#	Color	Depth	Width	Surface Hole Diameter	Price
SMUGR234B	Black Plastic	3"	3"	2 3/4"	N/C

Specify black grommet color. Silver grommet standard, black grommet optional at no charge.

Assemble

Assembly Option (For shell desk and credenza shell)

Model#	Price
SMASSEMBLY FEE	\$92/ea.

Assemble 2 legs and 1 modesty to 1 top. 1 Stabilizer bar is included with 60"W, 66"W & 72"W tops.



Face Lock Accessories

Model#	Description	Price
MM-CORE-KEYS	Lock core & 1 set of keys	\$67
MM-MASTER KEY	Unlocks Maverick locks	\$88
MMREMOVAL KEY	Removes Maverick lock cores	\$88

For core/keys replacement: Specify lock/key number and core color. Set of keys are not sold separately (keys ship with core).

summit series color options

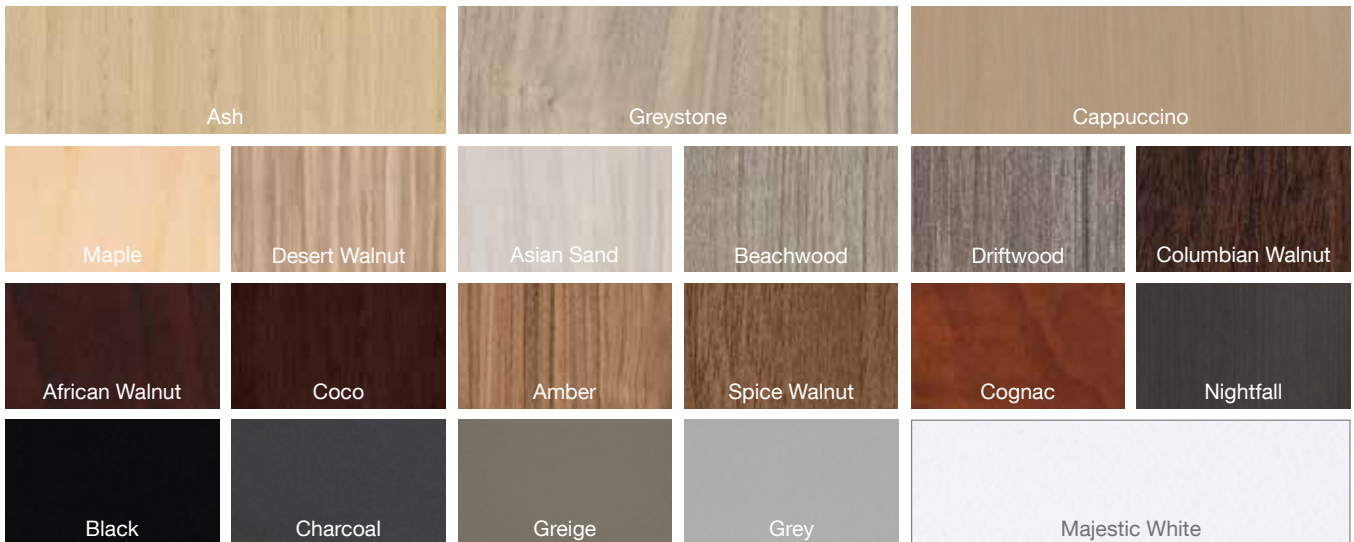

Two colors may be specified. HPL colors and three-color options are not available.

standard handle options

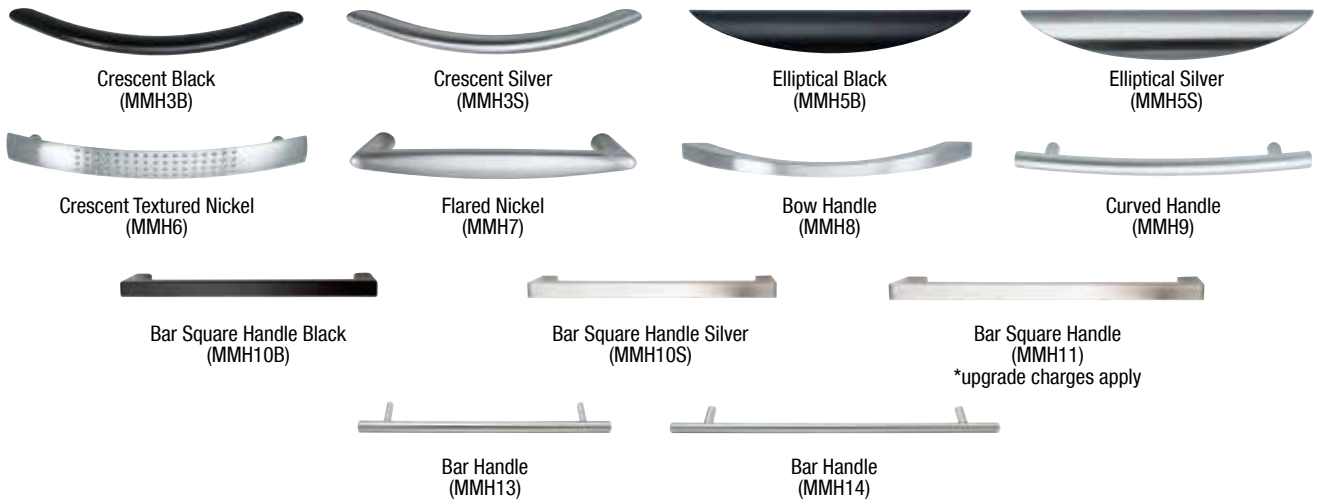

conference data/power management



Round Power Grommet



Metal Power Management Unit

Laminate finishes shown are approximations. Colors may vary between factories.

For sample requests, email Maverick West: orderentry@maverickdesk.com. Maverick East: mveorders@maverickdesk.com

Note: Renderings & line drawings shown are a resemblance to finished product. Product designs may vary. Discounts are different between factories.