

Product Specifications

- 1" thick tops only, 2mm PVC edge-banding, pilot holes for post leg brackets only and metal inserts for ganging brackets.
- Maverick Series has radiused corners, Arroyo Series has square corners.
- Available in 20 standard colors, see color chart for upcharge information. Two colors may be specified at no charge.
- No up-charge for contrasting color edge-banding.
- Legs and ganging hardware are ordered separately from the tops and are not factory installed.
- All training and height adjustable tables can be assembled upon request at no charge.
- Tops are predrilled for leg/base where specified on leg/base style items.

How to Order Training Tables

WORKSURFACE UNITS

1. Product number: **MM TR 24 60**

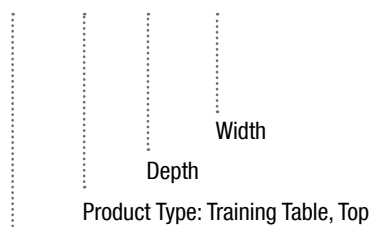

Series Name: Maverick with radius corners is MM, Arroyo with square corners is AR.

2. Specify worksurface color - Choose from 20 standard colors.
3. Specify edge-banding color - Matching top color is standard.
4. Specify other accessories and upgrades. Grommet options on page 130. See grommet locations below.
5. Legs are ordered separately. Specify from available legs on pages 126–129.
6. Ganging and connecting hardware is ordered separately. See page 130.

MAVERICK SERIES (MM)

EDGE PROFILE-RADIUS

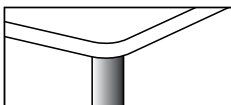

2MM FLAT PVC EDGE BANDING ON TOPS

ARROYO SERIES (AR)

EDGE PROFILE-SQUARE

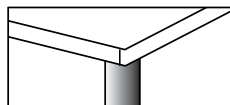

2MM FLAT PVC EDGE BANDING ON TOPS

GROMMET OPTIONS

BLACK AND SILVER



TRAINING TABLE TOP STANDARD GROMMET LOCATIONS (Unless otherwise specified)

Note: While sitting at unit, grommet locations are named from left to right. Line drawings shown below are standard locations.

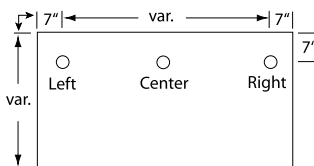

Rectangular
24" or 30"

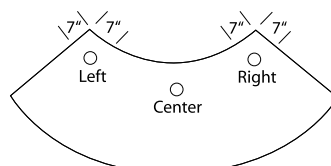

Curved
24" or 30"

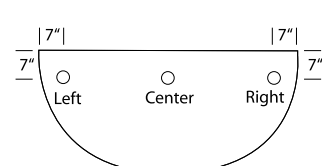

Half-Round
48" or 60"

training tables

Training Worksurfaces

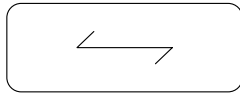
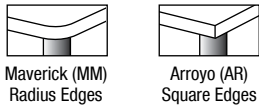

Maverick

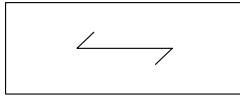

Arroyo

Rectangular Training Table Top, 20"D Tops (MM radius edges, AR square edges)

Model#	Depth	Width	Height	Weight	Cube	MM Price	AR Price
__TR2036	20"	36"	1"	23	1	\$271	\$241
__TR2042	20"	42"	1"	27	1	\$276	\$247
__TR2048	20"	48"	1"	30	1	\$289	\$262
__TR2054	20"	54"	1"	34	1	\$306	\$277
__TR2060	20"	60"	1"	38	1	\$350	\$315
__TR2066	20"	66"	1"	42	1	\$371	\$336
__TR2072*	20"	72"	1"	45	1	\$401	\$365
__TR2078*	20"	78"	1"	49	1	\$459	\$415
__TR2084*	20"	84"	1"	53	1	\$503	\$452

Note: When ordering, insert MM for Maverick Series or AR for Arroyo Series. Wood grain runs the width direction.

*Tops: 72"W, 78"W & 84"W requires 5 post legs.

Stabilizer Bar: 2 are included with 60"W, 66"W & 72"W tops, when ordered with post legs.

Max weight 50 lbs.

Pre Drilled Holes: Tops are pre-drilled for 4 post legs MMLEGTRB – MMLEGTRSC.

Ganging Hardware: Is recommended when placing tops side by side.  Lead Time.

Rectangular Training Table Top, 24"D Tops (MM radius edges, AR square edges)

Model#	Depth	Width	Height	Weight	Cube	MM Price	AR Price
__TR2436	24"	36"	1"	30	1	\$365	\$329
__TR2442	24"	42"	1"	32	1	\$377	\$341
__TR2448	24"	48"	1"	36	1	\$393	\$359
__TR2454	24"	54"	1"	40	1	\$409	\$371
__TR2460	24"	60"	1"	45	1	\$422	\$377
__TR2466	24"	66"	1"	50	1	\$445	\$401
__TR2472*	24"	72"	1"	54	1	\$459	\$415
__TR2478*	24"	78"	1"	59	1	\$503	\$452
__TR2484*	24"	84"	1"	63	1	\$533	\$480

Note: When ordering, insert MM for Maverick Series or AR for Arroyo Series. Wood grain runs the width direction.

*Tops: 72"W, 78"W & 84"W requires 5 post legs.

Stabilizer Bar: 2 are included with 60"W, 66"W & 72"W tops, when ordered with post legs.

Max weight 50 lbs.

Pre Drilled Holes: Tops are pre-drilled for 4 post legs MMLEGTRB – MMLEGTRSC.

Ganging Hardware: Is recommended when placing tops side by side.  Lead Time.

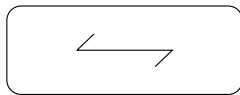

Maverick

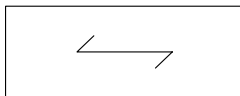

Arroyo

Rectangular Training Table Top, 30"D Tops (MM radius edges, AR square edges)

Model#	Depth	Width	Height	Weight	Cube	MM Price	AR Price
__TR3048	30"	48"	1"	45	1	\$377	\$341
__TR3054	30"	54"	1"	51	1	\$386	\$350
__TR3060	30"	60"	1"	57	1	\$423	\$377
__TR3066	30"	66"	1"	62	1	\$468	\$423
__TR3072*	30"	72"	1"	68	2	\$510	\$459
__TR3078*	30"	78"	1"	74	2	\$581	\$523
__TR3084*	30"	84"	1"	79	2	\$643	\$582

Note: When ordering, insert MM for Maverick Series or AR for Arroyo Series. Wood grain runs the width direction.

*Tops: 72"W, 78"W & 84"W requires 5 post legs.

Stabilizer Bar: 2 are included with 60"W, 66"W & 72"W tops, when ordered with post legs.

Max weight 50 lbs.

Pre-drilled Holes: Tops are pre-drilled for 4 post legs MMLEGTRB – MMLEGTRSC.

Ganging Hardware: Is recommended when placing tops side by side.  Lead Time.

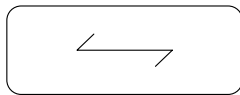

Maverick

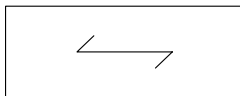

Arroyo

training tables

Training Worksurfaces

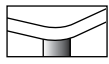

Maverick (MM)
Radius Edges

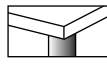

Arroyo (AR)
Square Edges

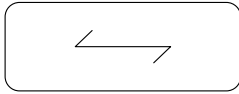

Maverick

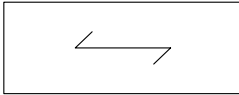

Arroyo

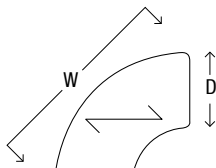

Maverick

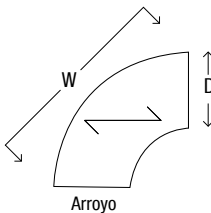

Arroyo

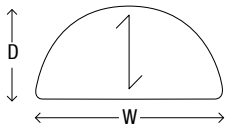

Maverick

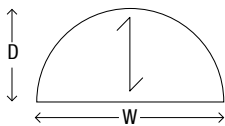

Arroyo



WG24 & WG30

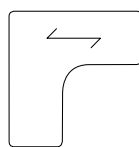

Maverick

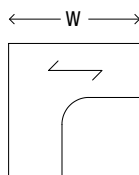

Arroyo

Rectangular Training Table Top, 36" D Tops (MM radius edges, AR square edges)

Model#	Depth	Width	Height	Weight	Cube	MM Price	AR Price
__TR3660	36"	60"	1"	68	1	\$560	\$510
__TR3666	36"	66"	1"	75	1	\$606	\$546
__TR3672*	36"	72"	1"	81	2	\$634	\$576

Note: When ordering, insert MM for Maverick Series or AR for Arroyo Series. Wood grain runs the width direction.
*Top: 72"W requires 5 post legs.

Stabilizer Bar: 2 are included with 60"W, 66"W & 72"W tops, when ordered with post legs.

Max weight 50 lbs.

Pre-drilled Holes: Tops are pre-drilled for 4 post legs MMLEGTRB – MMLEGTRSC.

Ganging Hardware: Is recommended when placing tops side by side. Lead Time.

Curved Training Table Top (Must be ganged with another top for stability)

Model#	Depth	Width	Height	Weight	Cube	MM Price	AR Price
__TRQ2460L	24"	60"	1"	27	1	\$431	\$388
__TRQ2460R	24"	60"	1"	27	1	\$431	\$388
__TRQ3060L	30"	60"	1"	33	2	\$476	\$431
__TRQ3060R	30"	60"	1"	33	2	\$476	\$431

Note: When ordering, insert MM for Maverick Series or AR for Arroyo before model number.

On "L" units, from users' view, woodgrain direction is parallel with right edge and perpendicular with left edge.

On "R" units wood-grain is parallel with the left edge and perpendicular with the right edge.

If not ganged, order 5th leg for stability.

Pre-drilled Holes: Tops are pre-drilled for post legs MMLEGTRB – MMLEGTRS.

Ganging Hardware: Is recommended when placing tops side by side. Lead Time.

Half-Round Training Table Top (48" & 60" require four legs and two ganging plates)

Model#	Depth	Width	Height	Weight	Cube	MM Price	AR Price
__TRWH1224	12"	24"	1"	6	1	\$215	\$171
__TRWH1224WG24	12"	24"	1"	6	1	\$215	\$171
__TRWH1530	15"	30"	1"	10	1	\$261	\$216
__TRWH1530WG30	15"	30"	1"	10	1	\$261	\$216
__TRWH2448	24"	48"	1"	24	1	\$543	\$499
__TRWH3060	30"	60"	1"	37	1	\$649	\$499

Note: When ordering, insert MM for Maverick Series or AR for Arroyo before model number.

Woodgrain direction runs the depth to coordinate with woodgrain direction on rectangular worksurfaces.

12" & 15" deep require only 1 leg and 1 ganging plate.

12" & 15" deep (WG24 & WG30), the woodgrain runs the width to coordinate with the grain on 1 end of curved units.

Pre-drilled Holes: Tops are pre-drilled for post legs MMLEGTRB – MMLEGTRS.

Ganging Hardware: Is recommended when placing tops side by side. Lead Time.

Curved Corner Training Table Top (48" & 60" require four legs and two ganging plates)

Model#	Depth	Width	Height	Weight	Cube	MM Price	AR Price
__TRCWS424224	24"	42"/42"	1"	24	1	\$559	\$499
__TRCWS424230	30"	42"/42"	1"	24	1	\$559	\$499
__TRCWS484824	24"	48"/48"	1"	30	1	\$650	\$579
__TRCWS484830	30"	48"/48"	1"	30	1	\$650	\$650
__TRCWS606024	24"	60"/60"	1"	47	1	\$814	\$730
__TRCWS606030	30"	60"/60"	1"	47	1	\$814	\$730

Note: When ordering, insert MM for Maverick Series or AR for Arroyo before model number.

Pre-drilled Holes: Tops are pre-drilled for post legs MMLEGTRB – MMLEGTRS.

Ganging Hardware: Is recommended when placing tops side by side. Lead Time.

training tables

Training Worksurfaces 15 DAYS

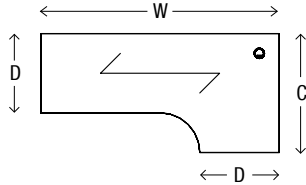
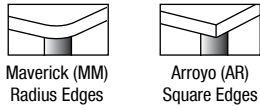

Curved Computer Training Table Top 24"D Right Connection (MM Radius Edges, AR Square Edges)

Model#	Depth	Width	Corner (c)	Height	Weight	Cube	MM Price	AR Price
__CDQ60TOP 4R	24" / 24"	60"	36"	1"	68	2	\$658	\$587
__CDQ66TOP 4R	24" / 24"	66"	36"	1"	68	2	\$694	\$622
__CDQ72TOP 4R	24" / 24"	72"	36"	1"	79	2	\$714	\$644
__CDQ72TOP 9R	30" / 24"	72"	42"	1"	79	2	\$756	\$685

Note: When ordering, insert MM for Maverick Series or AR for Arroyo Series. Wood grain runs the width direction. Maverick series tops have three radius corners.

Pre-drilled Holes: Tops are not pre-drilled. Must order with return top. Designed for Adjustable Height L-Unit Base only.

Grommet: Standard black grommet, location 7"x7" upgrade grommet to color silver at no charge.

15 LEAD TIME

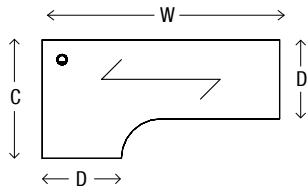

Curved Computer Training Table Top 24"D Left Connection (MM Radius Edges, AR Square Edges)

Model#	Depth	Width	Corner (c)	Height	Weight	Cube	MM Price	AR Price
__CDQ60TOP 4L	24" / 24"	60"	36"	1"	68	2	\$658	\$587
__CDQ66TOP 4L	24" / 24"	66"	36"	1"	68	2	\$694	\$622
__CDQ72TOP 4L	24" / 24"	72"	36"	1"	79	2	\$714	\$644
__CDQ72TOP 9L	24" / 30"	72"	42"	1"	79	2	\$756	\$685

Note: When ordering, insert MM for Maverick Series or AR for Arroyo Series. Wood grain runs the width direction. Maverick series tops have three radius corners.

Pre-drilled Holes: Tops are not pre-drilled. Must order with return top. Designed for Adjustable Height L-Unit Base only.

Grommet: Standard black grommet, location 7"x7" upgrade grommet to color silver at no charge.

15 LEAD TIME

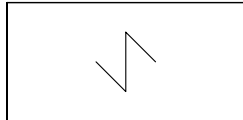

Rectangular Training Return Top, 24"D Tops (MM Radius Edges, AR Square Edges)

Model#	Depth	Width	Height	Weight	Cube	MM Price	AR Price
__TRT2436	24"	36"	1"	30	1	\$416	\$379
__TRT2442	24"	42"	1"	32	1	\$430	\$393
__TRT2448	24"	48"	1"	36	1	\$445	\$410

Note: When ordering, insert MM for Maverick Series or AR for Arroyo Series. Return top wood grain runs vertical direction. Maverick series tops have two radius edges.

Pre-drilled Holes: Tops are not pre-drilled. Must order with computer table top. Designed for Adjustable Height L-Unit Base only.

Connecting Hardware: 2 Connecting brackets with wood screws are included.

15 LEAD TIME

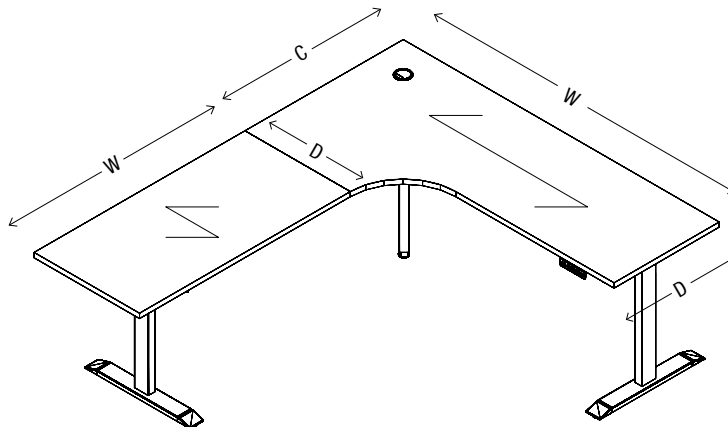

Note: Line drawings shown in square corners (AR series)

training tables

Bases, for Training Table Tops

(Leg heights vary and cannot be combined)



Post Leg 2 3/8" diameter (Set of 4 legs) for Training Table Tops

Model#	Description	Color	Weight	Cube	Height	Price
MMLEGTRB	4 Posts w/ Leveler	Black	14	1	27 13/16"	\$556
MMLEGTRS	4 Posts w/ Leveler	Brushed Steel	14	1	27 13/16"	\$556
MMLEGTRBC	4 Posts w/ Locking Casters	Black	14	1	27 15/16"	\$556
MMLEGTRSC	4 Posts w/ Locking Casters	Brushed Steel	14	1	27 15/16"	\$556
MMCULEG__	1 Individual Post Leg		14	1	27 15/16"	\$141

For individual post legs, add \$141/each. Specify complete model #MMCULEG__ (e.g. MMCULEGTRB). Individual post leg includes mounting screws.

Legs are shipped un-installed and require minor assembly with woodscrews for each leg. Tops 72"W, 78"W & 84"W requires 5 post legs. Tops are pre-drilled for 4 post legs only.

LEAD TIME

Flip Top Base with Frame Modesty, Locking Casters (1 Complete leg)

Model#	Depth	Width	Height	Fits Top Size	Color	Weight	Cube	Price
* MMLEGFFMB48T	14/20"	40 1/4"	28 1/2"	48" & 54"W	Titanium	36	1	\$677
MMLEGFFMB48B	14/20"	40 1/4"	28 1/2"	48" & 54"W	Black	36	1	\$677
* MMLEGFFMB48W	14/20"	40 1/4"	28 1/2"	48" & 54"W	White	36	1	\$677
MMLEGFFMB60T	14/20"	52"	28 1/2"	60" & 66"W	Titanium	40	1	\$753
* MMLEGFFMB60B	14/20"	52"	28 1/2"	60" & 66"W	Black	40	1	\$753
MMLEGFFMB60W	14/20"	52"	28 1/2"	60" & 66"W	White	40	1	\$753
MMLEGFFMB72T	14/20"	63 1/4"	28 1/2"	72" & 78"W	Titanium	43	1	\$880
MMLEGFFMB72B	14/20"	63 1/4"	28 1/2"	72" & 78"W	Black	43	1	\$880
MMLEGFFMB72W	14/20"	63 1/4"	28 1/2"	72" & 78"W	White	43	1	\$880

For rectangular tops 20"D & 24"D only, see page 123.

*Note: Color Titanium/Metal does not match other silver legs.

Bases ship unassembled unless otherwise specified. Tops are not pre-drilled.

LEAD TIME

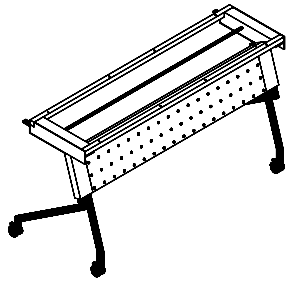

training tables

Bases, for Training Table Tops

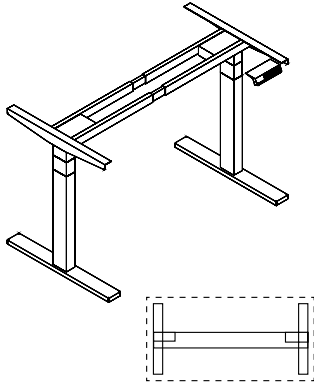

Adjustable Height Electrical Base (Sit to stand, fits top sizes below)

Model#	Base (D)	Base (W)	Height	Fits Top Size	Color	Weight	Cube	Price
MMLEGAHE24S3	22"	47"-72"	23 1/2"-49"	24"D-72"W	Silver	66	1	\$1,498
MMLEGAHE24B3	22"	47"-72"	23 1/2"-49"	24"D-72"W	Black	66	1	\$1,498
MMLEGAHE24W3	22"	47"-72"	23 1/2"-49"	24"D-72"W	White	66	1	\$1,498
MMLEGAHE30S3	28"	47"-72"	23 1/2"-49"	30"D-72"W	Silver	66	1	\$1,498
MMLEGAHE30B3	28"	47"-72"	23 1/2"-49"	30"D-72"W	Black	66	1	\$1,498
MMLEGAHE30W3	28"	47"-72"	23 1/2"-49"	30"D-72"W	White	66	1	\$1,498

Does not include top. **3 stage base.** Bases ship unassembled unless otherwise specified.

15 LEAD TIME

Handset	Push Button/4 memory presets
Motor	Dual motor
Foot Length	28"
Height range (excluding top)	23.5" – 49"
Frame width	Width adjustable 48" – 72"
Worksurface widths	48" – 72"
Worksurface depths	24" & 30"
Max lifting capacity	250lbs.
Base Weight	66lbs.
Speed	30mm/s
Warranty	5 years

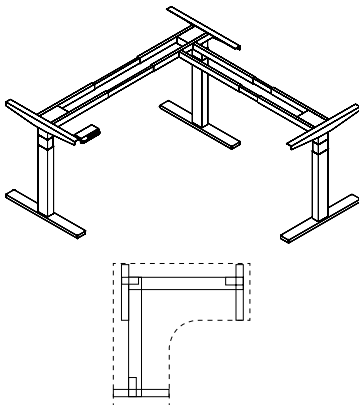

Adjustable Height Electrical L-Unit Base (Sit to stand, fits top sizes below)

Model#	Base (D)	Base (W)	Height	Fits Top Size	Color	Weight	Cube	Price
MMLEGAHEL24B3	22"	48"-72"	23 1/2"-49"	24"D-72"W	Black	112	1	\$2,295
MMLEGAHEL24S3	22"	48"-72"	23 1/2"-49"	24"D-72"W	Silver	112	1	\$2,295
MMLEGAHEL24W3	22"	48"-72"	23 1/2"-49"	24"D-72"W	White	112	1	\$2,295
MMLEGAHEL30S3	28"	48"-72"	23 1/2"-49"	30"D-72"W	Silver	112	1	\$2,295
MMLEGAHEL30W3	28"	48"-72"	23 1/2"-49"	30"D-72"W	White	112	1	\$2,295
MMLEGAHEL30B3	28"	48"-72"	23 1/2"-49"	30"D-72"W	Black	112	1	\$2,295

Does not include top. **3 stage base.** Bases ship unassembled unless otherwise specified.

15 LEAD TIME

Handset	Push Button/4 memory presets
Motor	Triple motor
Foot Length	28"
Height range (excluding top)	23.5" – 49"
Frame width	Width adjustable 48" – 72"
Worksurface widths	48" – 72"
Worksurface depths	24" & 30"
Max lifting capacity	300lbs.
Base Weight	112lbs.
Speed	33mm/s
Warranty	5 years

training tables

Bases, for Training Table Tops

T-Leg with Leveler (Set of 2 legs)

Model#	Depth	Width	Height	Fits Top Size	Color	Weight	Cube	Price
MMLEGL20B	20"	2 1/4"	28"	20/24"D-72"W	Black	23	4	\$1,008
MMLEGL20S	20"	2 1/4"	28"	20/24"D-72"W	Silver	23	4	\$1,008
MMLEGL20W	20"	2 1/4"	28"	20/24"D-72"W	White	23	4	\$1,008
MMLEGL30B	30"	2 1/4"	28"	30/36"D-72"W	Black	23	4	\$1,083
MMLEGL30S	30"	2 1/4"	28"	30/36"D-72"W	Silver	23	4	\$1,083
MMLEGL30W	30"	2 1/4"	28"	30/36"D-72"W	White	23	4	\$1,083

Column diameter 2 1/4". Mounting plate 6"D x 8"W. Base Spread: 20"D is 20"W. 30"D is 26"W.
Stabilizer Bar: 1 is included with 60"W, 66"W & 72"W tops, when ordered with T-Legs.
Legs ship unassembled unless otherwise specified. **15** LEAD TIME

T-Leg with Casters (Set of 2 legs, locking casters)

Model#	Depth	Width	Height	Fits Top Size	Color	Weight	Cube	Price
MMLEGTC20B	20"	2 1/4"	28"	20/24"D-72"W	Black	23	4	\$1,028
MMLEGTC20S	20"	2 1/4"	28"	20/24"D-72"W	Silver	23	4	\$1,028
MMLEGTC20W	20"	2 1/4"	28"	20/24"D-72"W	White	23	4	\$1,028
MMLEGTC30B	30"	2 1/4"	28"	30/36"D-72"W	Black	23	4	\$1,103
MMLEGTC30S	30"	2 1/4"	28"	30/36"D-72"W	Silver	23	4	\$1,103
MMLEGTC30W	30"	2 1/4"	28"	30/36"D-72"W	White	23	4	\$1,103

Column diameter 2 1/4". Mounting plate 6"D x 8"W. Base Spread: 20"D is 20"W. 30"D is 26"W.
Stabilizer Bar: 1 is included with 60"W, 66"W & 72"W tops, when ordered with T-Legs.
Legs ship unassembled unless otherwise specified. **15** LEAD TIME

Flip Top Base with Leveler (Set of 2 legs)

Model#	Depth	Width	Height	Fits Top Size	Color	Weight	Cube	Price
MMLEGTFL20B	20"	2 1/4"	28"	20/24"D-72"W	Black	23	4	\$1,331
MMLEGTFL20S	20"	2 1/4"	28"	20/24"D-72"W	Silver	23	4	\$1,331
MMLEGTFL20W	20"	2 1/4"	28"	20/24"D-72"W	White	23	4	\$1,331
MMLEGTFL30B	30"	2 1/4"	28"	30/36"D-72"W	Black	23	4	\$1,379
MMLEGTFL30S	30"	2 1/4"	28"	30/36"D-72"W	Silver	23	4	\$1,379
MMLEGTFL30W	30"	2 1/4"	28"	30/36"D-72"W	White	23	4	\$1,379

Column diameter 2 1/4". Flip top mechanism is mechanically attached to the base.
Base Spread: 20"D is 20"W. 30"D is 26"W. Use with rectangular tops, see pages 123-124.
Stabilizer Bar: 1 is included with 60"W, 66"W & 72"W tops, when ordered with Flip Top Base.
Base ship unassembled unless otherwise specified. **15** LEAD TIME

Flip Top Base with Casters (Set of 2 legs, locking casters)

Model#	Depth	Width	Height	Fits Top Size	Color	Weight	Cube	Price
MMLEGTFC20B	20"	2 1/4"	28"	20/24"D-72"W	Black	23	4	\$1,400
MMLEGTFC20S	20"	2 1/4"	28"	20/24"D-72"W	Silver	23	4	\$1,400
MMLEGTFC20W	20"	2 1/4"	28"	20/24"D-72"W	White	23	4	\$1,400
MMLEGTFC30B	30"	2 1/4"	28"	30/36"D-72"W	Black	23	4	\$1,449
MMLEGTFC30S	30"	2 1/4"	28"	30/36"D-72"W	Silver	23	4	\$1,449
MMLEGTFC30W	30"	2 1/4"	28"	30/36"D-72"W	White	23	4	\$1,449

Column diameter 2 1/4". Flip top mechanism is mechanically attached to the base.
Base Spread: 20"D is 20"W. 30"D is 26"W. Use with rectangular tops, see pages 123-124.
Stabilizer Bar: 1 is included with 60"W, 66"W & 72"W tops, when ordered with Flip Top Base.
Base ship unassembled unless otherwise specified. **15** LEAD TIME

NOTES:

- All bases on this page, for heavy use on 60"W or wider tops, a second stabilizer bar is recommended.
- If using 84"W tops, one stabilizer bar MMSB72 is required.
- See page 130 for stabilizer bar sizes & pricing.

Hinged Modesty Panels available for Bases above, see page 130.

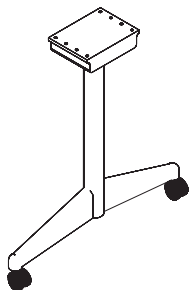
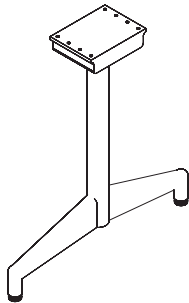
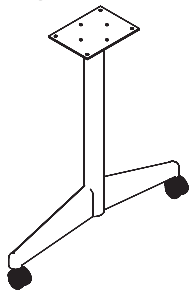
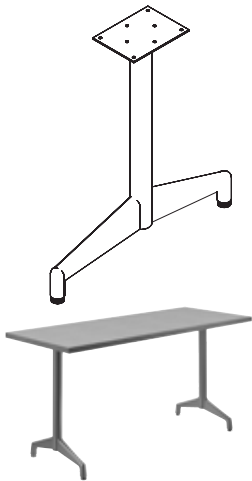

training tables

Bases, for Training Table Tops

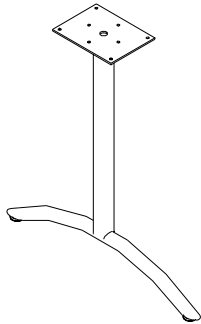

Arch T-Metal Base with Levelers (Set of 2 legs)

Model#	Depth	Width	Height	Fits Top Depth	Color	Weight	Cube	Price
MMLEGATL22B	22"	2"	27 3/4"	20-24"D-72"W	Black	23	4	\$1,213
MMLEGATL22S	22"	2"	27 3/4"	20-24"D-72"W	Silver	23	4	\$1,213
MMLEGATL22W	22"	2"	27 3/4"	20-24"D-72"W	White	23	4	\$1,213
MMLEGATL26B	26"	2"	27 3/4"	30-36"D-72"W	Black	23	4	\$1,241
MMLEGATL26S	26"	2"	27 3/4"	30-36"D-72"W	Silver	23	4	\$1,241
MMLEGATL26W	26"	2"	27 3/4"	30-36"D-72"W	White	23	4	\$1,241

Column diameter 2". Mounting plate 6"D x 8"W.
Stabilizer Bar: 1 is included with 60"W, 66"W & 72"W tops, when ordered with T-Legs.
Legs ship unassembled unless otherwise specified. Ⓛ LEAD TIME

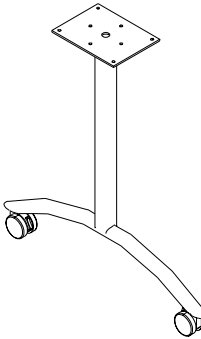

Arch T-Metal Base with Casters (Set of 2 legs)

Model#	Depth	Width	Height	Fits Top Depth	Color	Weight	Cube	Price
MMLEGATC22B	22"	2"	27 3/4"	20-24"D-72"W	Black	23	4	\$1,324
MMLEGATC22S	22"	2"	27 3/4"	20-24"D-72"W	Silver	23	4	\$1,324
MMLEGATC22W	22"	2"	27 3/4"	20-24"D-72"W	White	23	4	\$1,324
MMLEGATC26B	26"	2"	27 3/4"	30-36"D-72"W	Black	23	4	\$1,365
MMLEGATC26S	26"	2"	27 3/4"	30-36"D-72"W	Silver	23	4	\$1,365
MMLEGATC26W	26"	2"	27 3/4"	30-36"D-72"W	White	23	4	\$1,365

Column diameter 2". Mounting plate 6"D x 8"W.
Stabilizer Bar: 1 is included with 60"W, 66"W & 72"W tops, when ordered with T-Legs.
Legs ship unassembled unless otherwise specified. Ⓛ LEAD TIME

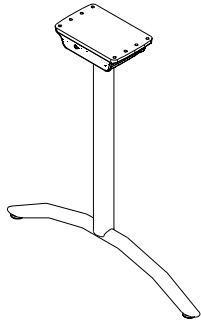

Flip Top Arch T-Metal Base with Levelers (Set of 2 legs)

Model#	Depth	Width	Height	Fits Top Depth	Color	Weight	Cube	Price
MMLEGATFL22B	22"	2"	27 3/4"	20-24"D-72"W	Black	23	4	\$2,134
MMLEGATFL22S	22"	2"	27 3/4"	20-24"D-72"W	Silver	23	4	\$2,134
MMLEGATFL22W	22"	2"	27 3/4"	20-24"D-72"W	White	23	4	\$2,134
MMLEGATFL26B	26"	2"	27 3/4"	30-36"D-72"W	Black	23	4	\$2,175
MMLEGATFL26S	26"	2"	27 3/4"	30-36"D-72"W	Silver	23	4	\$2,175
MMLEGATFL26W	26"	2"	27 3/4"	30-36"D-72"W	White	23	4	\$2,175

Column diameter 2". Flip top mechanism is mechanically attached to the base.
Use with rectangular tops, see pages 123-124.
Stabilizer Bar: 1 is included with 60"W, 66"W & 72"W tops, when ordered with Flip Top Base.
Base ship unassembled unless otherwise specified. Ⓛ LEAD TIME

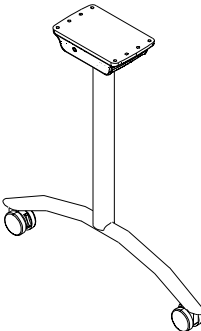

Flip Top Arch T-Metal Base with Casters (Set of 2 legs)

Model#	Depth	Width	Height	Fits Top Depth	Color	Weight	Cube	Price
MMLEGATFC22B	22"	2"	27 3/4"	20-24"D-72"W	Black	23	4	\$2,258
MMLEGATFC22S	22"	2"	27 3/4"	20-24"D-72"W	Silver	23	4	\$2,258
MMLEGATFC22W	22"	2"	27 3/4"	20-24"D-72"W	White	23	4	\$2,258
MMLEGATFC26B	26"	2"	27 3/4"	30-36"D-72"W	Black	23	4	\$2,285
MMLEGATFC26S	26"	2"	27 3/4"	30-36"D-72"W	Silver	23	4	\$2,285
MMLEGATFC26W	26"	2"	27 3/4"	30-36"D-72"W	White	23	4	\$2,285

Column diameter 2". Flip top mechanism is mechanically attached to the base.
Use with rectangular tops, see pages 123-124.
Stabilizer Bar: 1 is included with 60"W, 66"W & 72"W tops, when ordered with Flip Top Base.
Base ship unassembled unless otherwise specified. Ⓛ LEAD TIME

NOTES:

- All bases on this page, for heavy use on 60"W or wider tops, a second stabilizer bar is recommended.
- If using 84"W tops, one stabilizer bar MMSB72 is required.
- See page 130 for stabilizer bar sizes & pricing.



Hinged Modesty Panels available for Bases above, see page 130.

training tables

Modesty Panels

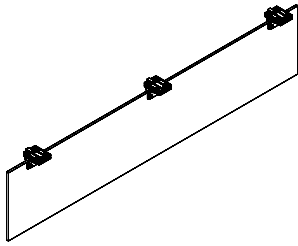

Frosted Acrylic Hinged Modesty (3/8" Thick, black clips)

Model#	Depth	Width	Height	Clips	Top Width	Weight	Cube	Price
MMTRAM54	3"	41"	13 1/2"	2	54"	10	2	\$986
MMTRAM60	3"	47"	13 1/2"	2	60"	11	2	\$991
MMTRAM66	3"	53"	13 1/2"	3	66"	12	2	\$1,066
MMTRAM72	3"	59"	13 1/2"	3	72"	13	2	\$1,075

Designed to fit T-Legs and Flip Top Bases, see page 129. Modesty recommended inset: 20"D & 24"D is flush, 30"D is inset 6". Depth and Height includes clips. Must be field installed.

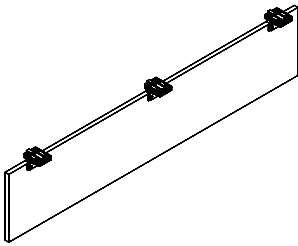

TFM Hinged Modesty (3/4" Thick, black clips)

Model#	Depth	Width	Height	Clips	Top Width	Weight	Cube	Price
MMTRWM54	3"	41"	13 1/2"	2	54"	10	2	\$321
MMTRWM60	3"	47"	13 1/2"	2	60"	11	2	\$345
MMTRWM66	3"	53"	13 1/2"	3	66"	12	2	\$424
MMTRWM72	3"	59"	13 1/2"	3	72"	13	2	\$424

Designed to fit T-Legs and Flip Top Bases, see page 129. Modesty recommended inset: 20"D & 24"D is flush, 30"D is inset 6". Depth and Height includes clips. Must be field installed.

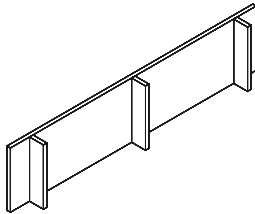

TFM Modesty (3/4" Thick, three vertical supports)

Model#	Depth	Width	Height	Top Width	Weight	Cube	Price
APPSLW54	4"	47"	12"	54"	15	2	\$152
APPSLW60	4"	53"	12"	60"	16	2	\$175
APPSLW66	4"	59"	12"	66"	18	2	\$186
APPSLW72	4"	65"	12"	72"	19	2	\$186

Ships with brackets for field installed. Tops are not predrilled.

NOTE: Modesty panel standard location is center left to right to approach side undertops. For custom location must specify, add MMCUT3 \$225.

Accessories and Upgrades

MMGANG3

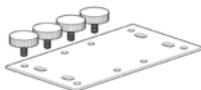

Ganging Hardware (For use with factory-installed metal inserts)

Model#	Depth	Width	Height	Hardware	Weight	Cube	Price
MMGANG3	4"	6"	1/4"	Ganging	1	1	\$52

MMGANG3: (1) Bracket & (4) Knobs. Recommended when placing tops side by side.



Grommet

Model#	Depth	Width	Color	Surface Hole Diameter	Price
MMGR234B	3"	3"	Black Plastic	2 3/4"	\$70
MMGR234S	3"	3"	Silver Plastic	2 3/4"	\$70
MMGR234BCOVER	Grommet cover only, Black (Field Install)				\$36
MMGR234SCOVER	Grommet cover only, Silver (Field Install)				\$36

Specify grommet locations. Standard left, right or center, see page 122 for standard location.

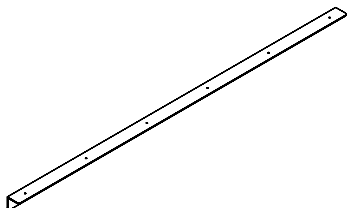

Stabilizer Bar, Black

Model#	Depth	Width	Height	Fits Top	Weight	Cube	Price
MMSB60	2"	44"	2"	60"W	6	1	\$149
MMSB66	2"	50"	2"	66"W	7	1	\$161
MMSB72	2"	56"	2"	72" / 84"W	8	1	\$174

May be purchased separately.

2 Stabilizer bars are included with 60"W, 66"W & 72"W tops, when purchased with top and post legs.